

ADM5120P/PX

Network Processor

Version AB

CONFIDENTIAL
Distribution with NDA

Communications



Never stop thinking

Edition 2005-11-09

**Published by Infineon Technologies AG,
St.-Martin-Strasse 53,
81669 München, Germany**

**© Infineon Technologies AG 2005.
All Rights Reserved.**

Attention please!

The information herein is given to describe certain components and shall not be considered as a guarantee of characteristics.

Terms of delivery and rights to technical change reserved.

We hereby disclaim any and all warranties, including but not limited to warranties of non-infringement, regarding circuits, descriptions and charts stated herein.

Information

For further information on technology, delivery terms and conditions and prices please contact your nearest Infineon Technologies Office (www.infineon.com).

Warnings

Due to technical requirements components may contain dangerous substances. For information on the types in question please contact your nearest Infineon Technologies Office.

Infineon Technologies Components may only be used in life-support devices or systems with the express written approval of Infineon Technologies, if a failure of such components can reasonably be expected to cause the failure of that life-support device or system, or to affect the safety or effectiveness of that device or system. Life support devices or systems are intended to be implanted in the human body, or to support and/or maintain and sustain and/or protect human life. If they fail, it is reasonable to assume that the health of the user or other persons may be endangered.

CONFIDENTIAL

ADM5120P/PX Network Processor

CONFIDENTIAL

Revision History: 2005-11-09, Rev. 1.32

Previous Version:

Page	Subjects (major changes since last revision)
	31-Oct-2005: Updated Registers and deleted reference to 200 MHz support
	12-Nov-2005: Updated Table 7-"MII Management"

Trademarks

ABM[®], AOP[®], BlueMoon[®], ConverGate[®], C166[®], DuSLIC[®], FALC[®], GEMINAX[®], INCA[®], IOM[®], IPVD[®], Isac[®], IWE[®], IWORX[®], MuSLIC[®], OCTALFALC[®], OCTAT[®], QUADFALC[®], SCOUT[®], SEROCCO[®], S-GOLD[®], SICOFI[®], SIEGET[®], SMARTI[®], SOCRATES[®], VINETIC[®], WDTC[®], 10BaseS[®] are registered trademarks of Infineon Technologies AG.

ACE[™], ARCOFI[™], ASM[™], ASP[™], BlueNIX[™], DigiTape[™], DUALFALC[™], EasyPort[™], E-GOLD[™], E-GOLDlite[™], EPIC[™], IPAT-2[™], ELIC[™], IDEC[™], ITAC[™], M-GOLD[™], SCT[™], S-GOLD2[™], S-GOLD3[™], MUSAC[™], POTSWIRE[™], QUAT[™], S-GOLDlite[™], SICAT[™], SIDEC[™], SLICOFI[™], VDSLite[™], 10BaseV[™], 10BaseVX[™] are trademarks of Infineon Technologies AG.

Microsoft[®] and Visio[®] are registered trademarks of Microsoft Corporation. Linux[®] is a registered trademark of Linus Torvalds. FrameMaker[®] is a registered trademark of Adobe Systems Incorporated. APOXI[®] is a registered trademark of Comneon GmbH & Co. OHG. PrimeCell[®], RealView[®], ARM[®] are registered trademarks of ARM Limited. OakDSPCore[®], TeakLite[®] DSP Core, OCEM[®] are registered trademarks of ParthusCeva Inc.

IndoorGPS[™], GL-20000[™], GL-LN-22[™] are trademarks of Global Locate. ARM926EJ-S[™], ADS[™], Multi-ICE[™] are trademarks of ARM Limited.

Table of Contents

	Table of Contents	4
	List of Figures	7
	List of Tables	8
1	Product Overview	10
1.1	Overview	10
1.2	Features	10
1.2.1	ASIC Features	10
1.2.1.1	Processor	10
1.2.1.2	Networking	10
1.2.1.3	Memory Interface	11
1.2.1.4	System	11
1.2.2	Software Features	11
1.2.3	Typical Applications	11
1.3	Conventions	12
1.3.1	Data Lengths	12
2	Interface Description	13
2.1	Pin Description by Function	13
2.1.1	Section	13
2.1.2	Pin Diagram for P-FQFP-208-10 Package	14
2.1.3	Abbreviations	15
2.1.4	ADM5120P/PX Network Media Connection	16
2.1.5	Clock for Network	16
2.1.6	LED	17
2.1.7	MII Management	18
2.1.8	Memory Bus	19
2.1.9	SDRAM Control Signals	21
2.1.10	UART	22
2.1.11	JTAG	22
2.1.12	General Purpose I/O (GPIO)	23
2.1.13	USB	24
2.1.14	External CS/INT/Wait	25
2.1.15	Power and Ground	25
2.1.16	Regulator Interface	27
2.1.17	Miscellaneous	27
3	ADM5120P/PX System	28
3.1	System Memory Map	28
3.1.1	Memory Mapping Notes	30
3.2	System and Interrupt Registers Description	31
3.2.1	Interrupt Control Register Map	33
4	Main Processor	39
4.1	4Kc CPU Core Features	39
4.2	Functional Description	40
4.2.1	Endianness Mode	40
4.2.2	Coprocessor CP0	40
4.2.3	Execution Unit	41
4.2.4	Multiply Divide Unit	41

4.2.5	Memory Management Unit	41
4.2.6	Cache System	41
4.2.7	EJTAG Debug Unit	42
4.3	Register Description	42
4.3.1	BIU Registers	42
4.3.1.1		43
4.3.2	FPI Bus Register Description	45
4.3.2.1		46
5	MultiPort Memory Controller (MPMC)	49
5.1	Feature List	49
5.2	Functional Description	49
5.2.1	Static Memory Controller	49
5.2.1.1	Extended Wait Transfers	49
5.2.1.2	Wait State Generation	49
5.2.1.3	Static Memory Read Control	50
5.2.1.4	Static Memory Write Control	51
5.2.2	Dynamic Memory Controller	52
5.2.2.1	Dynamic Memory Controller Command Descriptions	52
5.2.2.2	Generic SDRAM Initialization Example	53
5.3	MPMC Registers Description	54
5.3.1	MPMC Registers	54
5.3.1.1	Registers Description	57
6	Ethernet Switch Controller	100
6.1	Switch Engine	100
6.1.1	Hashing Function	100
6.1.2	Learning Process	100
6.1.3	Routing	100
6.1.4	Forwarding	100
6.1.5	Buffer Management	100
6.1.6	Flow Control	101
6.1.7	Full Duplex	101
6.1.8	Half Duplex	101
6.1.9	Packet Priority and Class of Service (CoS)	101
6.1.10	VLAN	101
6.1.11	Address Table Access	102
6.1.12	Address Security	102
6.1.13	Bandwidth Control Function	102
6.1.14	MII Port	102
6.2	DMA Function Description	103
6.2.1	Send Descriptors Content	104
6.2.1.1	Control	104
6.2.2	Receive Descriptors Content	105
6.2.2.1	Control	105
6.2.2.2	Status	106
6.3	Switch Control Register Map	107
6.3.1	Registers Description	110
7	UART	167
7.1	Feature List	167
7.2	Functional Description	167
7.2.1	AMBA APB Interface	168

7.2.2	Register Block	168
7.2.3	Baud Rate Generator	168
7.2.4	Transmit FIFO	168
7.2.5	Receive FIFO	169
7.2.6	Transmit Logic	169
7.2.7	Receive Logic	169
7.3	UART Registers	170
7.3.1	UART Registers Description	172
8	USB 1.1 Host Controller	180
8.1	Feature List	180
8.2	USB 1.1 Function Description	180
8.2.1	Block Diagram	180
8.2.2	System Bus Interface	181
8.2.3	Operational Register	181
8.2.4	SIE	181
8.2.5	DPLL	182
8.2.6	Memory BIST	182
8.3	DMA Operation	182
8.3.1	Registers Description	183
8.3.1.1	Registers	185
8.3.1.2	Registers	187
8.3.2	DMA Operation	190
8.4	USB Control Status Register Map	193
8.4.1	USB Control Status Registers Description	195
9	Electrical Characteristics	211
9.1	Absolute Maximum Ratings	211
9.2	DC Characteristics	211
9.3	AC Timing	212
9.3.1	SDRAM Interface	212
9.3.2	Memory Bus Read Timing	215
9.3.3	Memory Bus Write Timing	216
10	Package Outlines	217
10.1	Plastic Quad Flat Package (P-FQFP) 208-pin	217
	Terminology	218

List of Figures

Figure 1	ADM5120P/PX Application	12
Figure 2	Pin Diagram for P-FQFP-208-10	14
Figure 3	ADM5120P/PX Block Diagram	28
Figure 4	System Memory Map	30
Figure 5	Main Processor Subsystem	40
Figure 6	Read with Two Clock Delay for Read Enable	50
Figure 7	Read with Two Wait State	50
Figure 8	Asynchronous Page Mode Read with 2 Wait State and 1 Sequential Wait State	51
Figure 9	Bus Turnaround	51
Figure 10	Write with Zero Wait State	51
Figure 11	Write with Two Wait State	52
Figure 12	Write with Two Clock Delay for Write Enable	52
Figure 13	UART block diagram	168
Figure 14	Block Diagram of Infineon USB 1.1 Host Controller	181
Figure 15	DMA Operation in Host Mode	191
Figure 16	Interrupt IN/OUT Transactions	192
Figure 17	Precharge Command	213
Figure 18	Active Command	213
Figure 19	Write Command	214
Figure 20	Read Command	214
Figure 21	Memory Bus Read Timing	215
Figure 22	Memory Bus Write Timing	216
Figure 23	P-FQFP-208-10 (Plastic Quad Flat Package)	217

List of Tables

Table 1	Abbreviations for Pin Type	15
Table 2	Abbreviations for Buffer Type	15
Table 3	Network Media Connection	16
Table 4	Clock for Network	16
Table 5	LED	17
Table 6	LED Program	17
Table 7	MII Management	18
Table 8	Memory Bus	19
Table 9	SDRAM Control Signals	21
Table 10	UART	22
Table 11	JTAG	22
Table 12	General Purpose I/O (GPIO)	23
Table 13	USB	24
Table 14	External CS/INT/Wait	25
Table 15	Power and Ground	25
Table 16	Regulator Interface	27
Table 17	Miscellaneous	27
Table 18	Registers Address Space	31
Table 19	Registers Overview	31
Table 20	Registers Access Types	32
Table 21	Registers Clock Domains	32
Table 22	Endian Setting	40
Table 23	Module Base Address - BIU	42
Table 24	Registers OverviewRegisters Overview from Chapter BIU Registers	43
Table 25	Module Base Address	46
Table 26	Registers OverviewRegisters Overview from Chapter FPI Bus Register Description	46
Table 27	Registers Address Space	54
Table 28	Registers Overview	54
Table 29	Registers Access Types	56
Table 30	Address Mapping Table	71
Table 31	Connection between ADM5120P/PX and MAC Controller	102
Table 32	Registers Address Space	107
Table 33	Registers Overview	107
Table 34	Registers Access Types	109
Table 35	Registers Clock Domains	109
Table 36	Registers Address Space	170
Table 37	Registers Overview	170
Table 38	Registers Access Types	171
Table 39	Registers Clock Domains	171
Table 40	Registers Address Space	183
Table 41	Registers Overview	183
Table 42	Registers Access Types	184
Table 43	Registers Clock Domains	184
Table 44	Registers Address Space	193
Table 45	Registers Overview	193
Table 46	Registers Access Types	194
Table 47	Registers Clock Domains	194
Table 48	Reserved Registers	202
Table 49	Absolute Maximum Ratings	211

Table 50	DC Characteristics	211
Table 51	SDRAM Interface Timing	212
Table 52	Memory Bus Read Timing	215
Table 53	Memory Bus Write Timing	216

1 Product Overview

The following chapter gives an overview of the ADM5120P/PX.

1.1 Overview

ADM5120P/PX is a high performance, highly integrated, and highly flexible SOC (System-On-Chip) that facilitates the combined functions of a SOHO/SME Gateway, NAT Router, Print Server and VPN Gateway in one package. ADM5120P/PX enables the sharing of IP-based broadband services throughout the home/office using wired computers, entertainment equipment, printers, and other intelligent devices.

The ADM5120P/PX is the environmentally friendly 'green' package version. This is in compliance with Directive 2002/95/EC of the European Parliament and of the Council of 27 January 2003 on the restriction of the use of certain hazardous substances in electrical and electronic equipment

Internally, the ADM5120P/PX ASIC consists of a high performance (227 MIPS) embedded MIPS CPU, an embedded switch engine, a 10/100M PHY, an embedded USB host, and interfaces for UART, SDRAM and Flash. The following diagram illustrates a system configuration that uses the supported functions/facilities of ADM5120P/PX

1.2 Features

The following describes the features of the ADM5120P/PX

1.2.1 ASIC Features

Description of ASIC features:

1.2.1.1 Processor

Processor features:

- MIPS 4Kc CPU
- Embedded cache, 8 Kbyte I-cache, 8 Kbyte D-cache
- Embedded memory management unit (MMU) – 32-entry TLB, organized as 16 entry pairs
- 175 MHz/227 MIPS

1.2.1.2 Networking

Networking features:

- 6 ports
- IEEE 802.3 Fast Ethernet
- 5 auto-MDIX (auto-crossover) twisted paired LAN interfaces, embedded 10/100M PHY
- 1 MII interface
- Flexible WAN port selection
- Embedded switch engine
- Embedded Data-buffer/Address-look-up table
- Look-up table read/write-able
- MAC layer security
- MAC clone solution
- MAC filtering, Bandwidth control
- Class of Services (CoS) with two priority levels
- Shared dynamic data buffer management, embedded SSRAM
- Port grouping VLAN (overlap-able)
- TCP/IP accelerator

1.2.1.3 Memory Interface

Memory features:

- SDRAM
- Two bank support (2 chip select pins)
- Each bank can support -- 1M x 32 up to 32M x 32bit (128M-byte)
- Flash
- NOR Flash boot
- NOR Flash: one banks support (1 chip select pin)
- NOR Flash: support – 1M x 8-bit, up to 1M x 32-bit (4M-byte)

1.2.1.4 System

- UART interface
- 4 GPIO pins
- USB 1.1 host
- Clock source
- 25 MHz crystal for 10/100
- 48 MHz crystal for USB
- 0.18 μ CMOS process
- 1.8 V/3.3 V dual power
- PQFP

1.2.2 Software Features

Description of software features:

- Linux/Nucleus Real-Time OS
- Linux-based and Nucleus-based turn key support
- Telnet
- IEEE 802.3 Ethernet Driver
- RS232 Driver for Console User Interface
- DHCP Server/Client
- PPP over Ethernet (PPPoE)
- Network Address Translation (NAT) for IP Address Mapping/Sharing/Security
- DNS Proxy
- Simple Network Time Protocol (SNTP)
- Firewall
- Web-Based Configuration: WEB and HTTP
- TFTP upload/download

1.2.3 Typical Applications

The typical applications of the ADM5120P/PX are:

- IEEE 802.3 SOHO/SME Gateway
- NAT Router
- Print Server (through USB1.1)

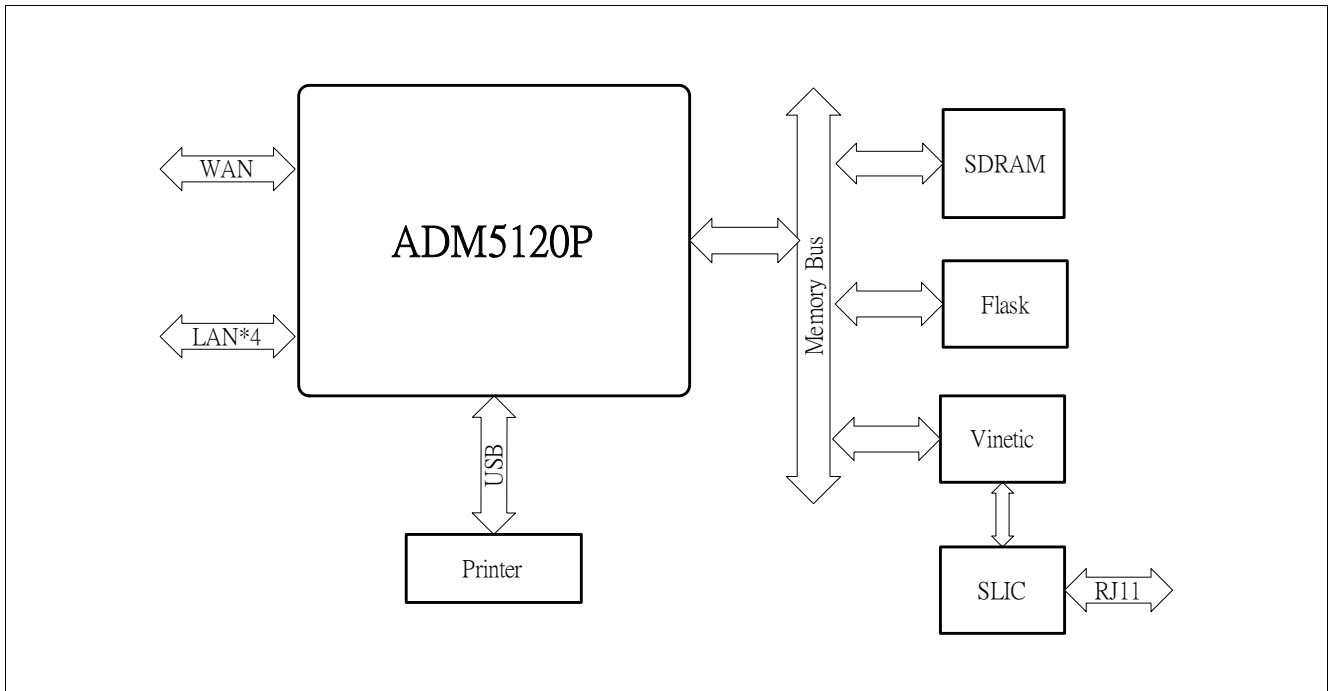

Figure 1 ADM5120P/PX Application

1.3 Conventions

The convention descriptions are described below:

1.3.1 Data Lengths

qword = 64 bits

dword = 32 bits

word = 16 bits

byte = 8 bits

nibble = 4 bits

2 Interface Description

2.1 Pin Description by Function

ADM5120P/PX pins are categorized into one of the following groups:

- [Section 2.1.4, ADM5120P/PX Network Media Connection](#)
- [Section 2.1.5, Clock for Network](#)
- [Section 2.1.6, LED](#)
- [Section 2.1.7, MII Management](#)
- [Section 2.1.8, Memory Bus](#)
- [Section 2.1.9, SDRAM Control Signals](#)
- [Section 2.1.10, UART](#)
- [Section 2.1.11 JTAG](#)
- [Section 2.1.12, General Purpose I/O \(GPIO\)](#)
- [Section 2.1.13, USB](#)
- [Section 2.1.14, External CS/INT/Wait](#)

2.1.1 Section

- [Section 2.1.15, Power and Ground](#)
- [Section 2.1.16, Regulator Interface](#)
- [Section 2.1.17, Miscellaneous](#)

Note: All default settings are 0.

2.1.2 Pin Diagram for P-FQFP-208-10 Package

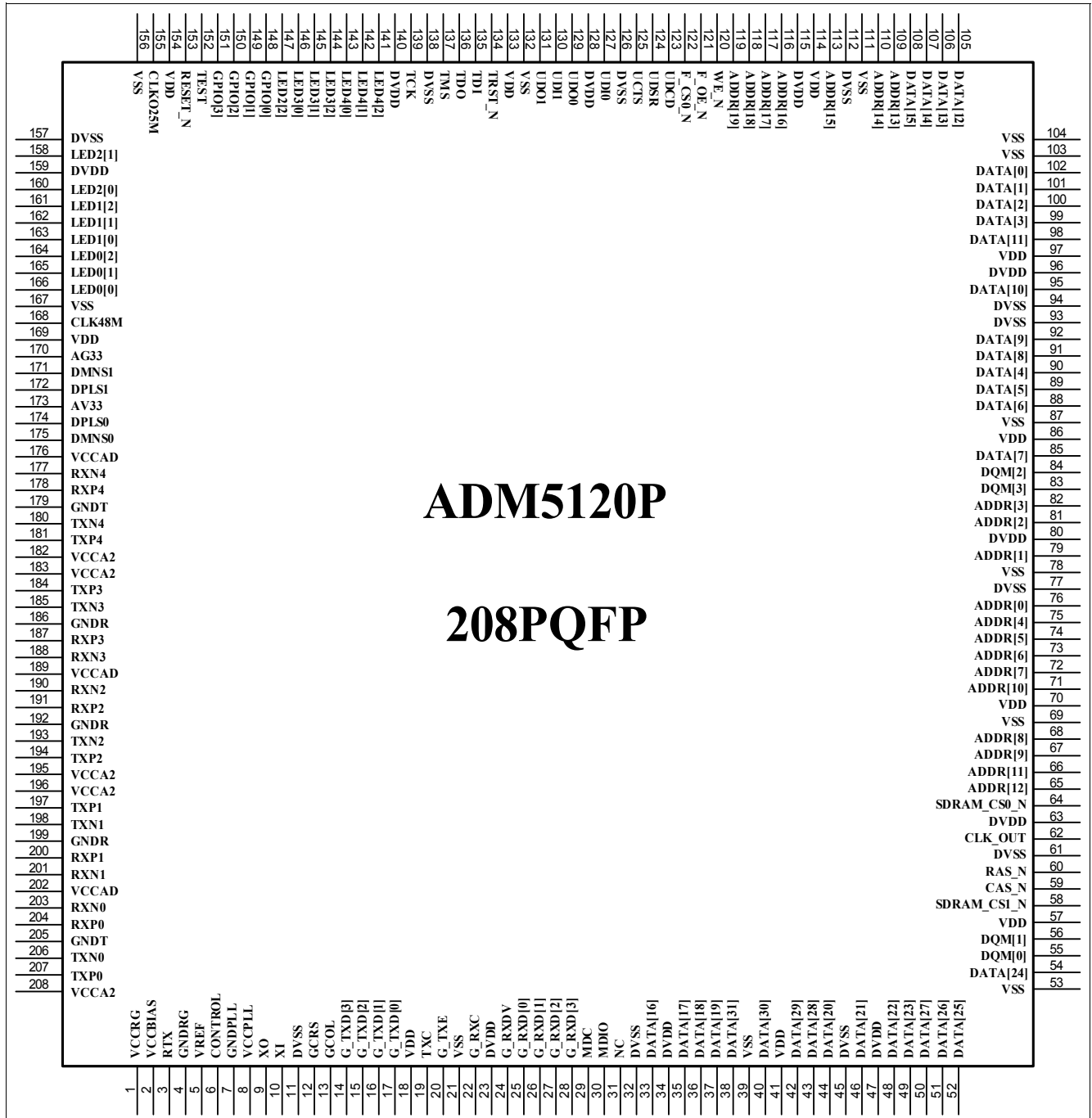

Figure 2 Pin Diagram for P-FQFP-208-10

2.1.3 Abbreviations

Table 1 Abbreviations for Pin Type

Abbreviations	Description
I	Standard input-only pin. Digital levels.
O	Output. Digital levels.
I/O	I/O is a bidirectional input/output signal.
AI	Input. Analog levels.
AO	Output. Analog levels.
AI/O	Input or Output. Analog levels.
PWR	Power
GND	Ground
MCL	Must be connected to Low (JEDEC Standard)
MCH	Must be connected to High (JEDEC Standard)
NU	Not Usable (JEDEC Standard)
NC	Not Connected (JEDEC Standard)

Table 2 Abbreviations for Buffer Type

Abbreviations	Description
Z	High impedance
PU1	Pull up, 10 k Ω
PD1	Pull down, 10 k Ω
PD2	Pull down, 20 k Ω
TS	Tristate capability: The corresponding pin has 3 operational states: Low, high and high-impedance.
OD	Open Drain. The corresponding pin has 2 operational states, active low and tristate, and allows multiple devices to share as a wire-OR. An external pull-up is required to sustain the inactive state until another agent drives it, and must be provided by the central resource.
OC	Open Collector
PP	Push-Pull. The corresponding pin has 2 operational states: Active-low and active-high (identical to output with no type attribute).
OD/PP	Open-Drain or Push-Pull. The corresponding pin can be configured either as an output with the OD attribute or as an output with the PP attribute.
ST	Schmitt-Trigger characteristics
TTL	TTL characteristics
A	Analog Differential pair or Analog PAD

2.1.4 ADM5120P/PX Network Media Connection

Table 3 Network Media Connection

Ball No.	Name	Pin Type	Buffer Type	Function
178	RXP4	AI	A	Receive Pair Differential data is received on these pins.
187	RXP3			
191	RXP2			
200	RXP1			
204	RXP0			
177	RXN4			
188	RXN3			
190	RXN2			
201	RXN1			
203	RXN0			
181	TXP4			
184	TXP3			
194	TXP2			
197	TXP1			
207	TXP0			
180	TXN4			
185	TXN3			
193	TXN2			
198	TXN1			
206	TXN0			

2.1.5 Clock for Network

Table 4 Clock for Network

Ball No.	Name	Pin Type	Buffer Type	Function
9	XOI	O	A	Crystal Clock Output 25 MHz crystal output
10	XI	I	A	External Clock Input 25 MHz crystal input
3	RTX	I	A	Reference Voltage

2.1.6 LED
Table 5 LED

Ball No.	Name	Pin Type	Buffer Type	Function
141	LED4_2	O	PD	LED 4 LED4_2 state, default = 1010, duplex/colLED4_1 state, default = 0101, speedLED4_0 state, default = 1001, link/activity
142	LED4_1			
143	LED4_0			
144	LED3_2	O	PD	LED 3 LED3_2 state, default = 1010, duplex/colLED3_1 state, default = 0101, speedLED3_0 state, default = 1001, link/activity
145	LED3_1			
146	LED3_0			
147	LED2_2	O	PD	LED 2 LED2_2 state, default = 1010, duplex/colLED2_1 state, default = 0101, speedLED2_0 state, default = 1001, link/activity
158	LED2_1			
160	LED2_0			
161	LED1_2	O	PD	LED 1 LED1_2 state, default = 1010, duplex/colLED1_1 state, default = 0101, speedLED1_0 state, default = 1001, link/activity
162	LED1_1			
163	LED1_0			
164	LED0_2	O	PD	LED 0 LED0_2 state, default = 1010, duplex/colLED0_1 state, default = 0101, speedLED0_0 state, default = 1001, link/activity
165	LED0_1			
166	LED0_0			

Note: Registers, not hardware pins, control the LED display. There are 3 LEDs per port, and they can be programmed to any state, the programming information can be found in [Table 6](#) below.

Table 6 LED Program

Function	State
GPIO_in (or GPIO_disable)	0000
GPIO_output_flash	0001
GPIO_output_1	0010
GPIO_output_0	0011
Link (steady)	0100
Speed (steady)	0101
Duplex (steady)	0110
Activity (flash)	0111
Collision (flash)	1000
Link+activity	1001
Duplex+collision	1010
10 M_link+activity	1011
100 M_link+activity	1100
Reserved	1101

Table 6 LED Program (cont'd)

Function	State
Reserved	1110
Reserved	1111

2.1.7 MII Management

Table 7 MII Management

Ball No.	Name	Pin Type	Buffer Type	Function
29	MDC	O	PP	Clock Input MDIO Runs at a 1 MHz frequency clock for MII port auto-negotiation result monitoring.
14	TXD_3	O		Transmit Data All internal pull down. 1. The force speed, duplex & flow control can be set by switch control register (B+14) 2. The reverse MII can only be set by switch control register (B+30)
15	TXD_2			
16	TXD_1			
17	TXD_0			
20	TXE	O		Transmit Enable Internal pull down.
24	RXDV	I	TTL/PU	Receive Data Valid Internal pull up.
28	RXD_3	I	TTL/PU	Receive Data Internal pull up.
27	RXD_2			
26	RXD_1			
25	RXD_0			
22	RXC	I	TTL/PD	Receive Clock Internal pull down.
19	TXC	I	TTL/PD	Transmit Clock Internal pull down.
12	CRS	I	TTL/PD	Carrier Sense Internal pull down.
13	COL	I	TTL/PD	Collision Internal pull down.
30	MDIO	BI	PD	Internal Pull Down Bi-directional serial pin used to write and read from the registers of the device.

2.1.8 Memory Bus

Table 8 Memory Bus

Ball No.	Name	Pin Type	Buffer Type	Function
38	DATA_31	BI	PD	Data Bus 31-0 Internal pull down. Data bus for SDRAM, flash memory, and external device.
40	DATA_30			
42	DATA_29			
43	DATA_28			
50	DATA_27			
51	DATA_26			
52	DATA_25			
54	DATA_24			
49	DATA_23			
48	DATA_22			
46	DATA_21			
44	DATA_20			
37	DATA_19			
36	DATA_18			
35	DATA_17			
33	DATA_16			
108	DATA_15			
107	DATA_14			
106	DATA_13			
105	DATA_12			
98	DATA_11			
95	DATA_10			
92	DATA_9			
91	DATA_8			
85	DATA_7			
88	DATA_6			
89	DATA_5			
90	DATA_4			
99	DATA_3			
100	DATA_2			
101	DATA_1			
102	DATA_0			

Table 8 Memory Bus (cont'd)

Ball No.	Name	Pin Type	Buffer Type	Function
119	ADDR_19	O	PD	Address Bus 19 Address bus for SDRAM, flash memory, and external device. Internal pull down. Pull down = Little Endian. (default)
118	ADDR_18			Address Bus 18-17 Internal pull down. Can be pulled up and down as following: 00 _B boot in 8-bit mode (Flash memory) (default) 01 _B boot in 16-bit mode 10 _B boot in 32-bit mode 11 _B Reserved
117	ADDR_17			
116	ADDR_16			
113	ADDR_15			Address Bus 16-14 Test mode purpose. Normal mode = 000(Default)
110	ADDR_14			
109	ADDR_13			
65	ADDR_12			Address Bus 13 Default value: 0 0 _B PHY separate power on disable 1 _B PHY separate power on enable
66	ADDR_11			Address Bus 12 0 _B BGA package(Default) 1 _B 208 PQFP package
71	ADDR_10			
67	ADDR_9			Address Bus 11-5
68	ADDR_8			
72	ADDR_7			
73	ADDR_6			
74	ADDR_5			
75	ADDR_4			
82	ADDR_3			
81	ADDR_2			
79	ADDR_1			Address Bus 4-3 Can be pulled up and down as following: PLL frequency setting. 00 _B 175 MHz (Default) 01 _B Reserved 1X _B Reserved
76	ADDR_0			Address Bus 2 0 _B Enable AutoMDIX 1 _B Disable AutoMDIX (Default)
				Address Bus 1 Default value: 0 _B 0 _B NAND boot disable 1 _B NAND boot enable
				Address Bus 0 Default value: 0 _B 0 _B Normal operation 1 _B Simulation mode

2.1.9 SDRAM Control Signals

Table 9 SDRAM Control Signals

Ball No.	Name	Pin Type	Buffer Type	Function
62	CLK_OUT	O	TS	Clock Out SDRAM clock, the frequency is set by ADDR_4:3 <i>Note: 1=pull up, 0=pull down</i> 00 _D 87.5 MHz (Default) 01 _D Reserved 1X _B Reserved
121	F_OE_N	O	PP	Output Enable for External Memory Output enable for external memory banks, active low.
120	WE_N	O	PP	Write Enable for External Memory Write Enable for external memory banks and SDRAM.
122	F_CS0_N	O	PP	Chip Select for External Memory Chip select for external memory, like flash, bank0, active low.
60	RAS_N	O	PP	Raw Address Strobe Raw address strobe, active low.
64	SD_RAM_CS0_N	O	PP	SDRAM Chip Select 0 SDRAM chip select 0.
59	CAS_N	O	PP	Column Address Strobe Column address strobe, active low.
58	SD_RAM_CS1_N	O	PP	SDRAM Chip Select 1 SDRAM chip select 1.
83	DQM_3	O	PD	Data Mask Output to SDRAM
84	DQM_2			
56	DQM_1			
55	DQM_0			

2.1.10 UART

Table 10 UART

Ball No.	Name	Pin Type	Buffer Type	Function
123	UDCD	I	PD	Data Carrier Detect UART0 Data carrier detect (modem status input), active low.
124	UDSR			Data Set Ready UART0 Data set ready (modem status input), active low.
125	UCTS			Clear to Send UART0 clear to send (modem status input), active low.
127	UDI0			Receive Serial Data Input UART0 receive serial data input, Internal pull down.
129	UDO0	O		Transmit Serial Data Output UART0 transmit serial data output.
130	UDI1	I		Receive Serial Data Input UART1 receive serial data input, Internal pull down.
131	UDO1	O		Transmit Serial Data Output UART1 transmit serial data output.

2.1.11 JTAG

Table 11 JTAG

Ball No.	Name	Pin Type	Buffer Type	Function
139	TCK	I	PD	Test Clock JTAG test clock, Internal pull down.
137	TMS			Test Mode Select JTAG test mode select, Internal pull down.
136	TDO	O		Test Data Out JTAG test data out.
135	TDI	I		Test Data In JTAG test data in, Internal pull down.
134	TRST_N	I	TTL	Asynchronous Reset JTAG asynchronous reset (active low).

2.1.12 General Purpose I/O (GPIO)

Table 12 General Purpose I/O (GPIO)

Ball No.	Name	Pin Type	Buffer Type	Function
151	GPIO_3	BI	PD	BI General Purpose I/O Pin GPIO_3:0 are internal pull down.
150	GPIO_2			
149	GPIO_1			
148	GPIO_0			

2.1.13 USB

Table 13 USB

Ball No.	Name	Pin Type	Buffer Type	Function
171	DMNS1	BI	A	Data- of USB Port1 Differential data bus conforming to the USB 1.1.
172	DPLS1			Data+ of USB Port1 Differential data bus conforming to the USB 1.1.
175	DMNS0			Data- of USB Port0 Differential data bus conforming to the USB 1.1.
174	DPLS0			Data+ of USB Port0 Differential data bus conforming to the USB 1.1.
168	CLK48M	I	TTL	USB Clock Input

2.1.14 External CS/INT/Wait

Table 14 External CS/INT/Wait

Ball No.	Name	Pin Type	Buffer Type	Function
148	$\overline{\text{WAIT}}$	I	TTL	WAIT $\overline{\text{WAIT}}$ is available in switch control register GPIO_conf2 , bit CSX0 and CSX1 and EW . When CSX is active and MPMC is programmable then wait_state will time-out, then check the $\overline{\text{WAIT}}$ if high, then complete the access if low, then wait until $\overline{\text{WAIT}}$ goes high.
150	INTX0	I		External Interrupt Input 0 External interrupt input 0, active high, available if en_csx0_intx0 enable in the switch control register GPIO_config2 (B+BC), bit[4].
149	$\overline{\text{CSX0}}$	O	TS	External Chip Select 0 External chip select 0, active low, available if en_csx0_intx0 is enabled in the switch control register GPIO_conf2 bit[4] CSX0 .
151	$\overline{\text{CSX1}}$	O	TS	External Chip Select 1 External chip select 1, active low, available if en_csx1_intx1 is enabled in the switch control register GPIO_config2 (B+BC), bit[5].

2.1.15 Power and Ground

Table 15 Power and Ground

Ball No.	Name	Pin Type	Buffer Type	Function
18, 41, 57, 70, 86, 97, 114, 133, 154, 169	VDD		A	Positive Power for Digital Core, 1.8 V
23, 34, 47, 63, 80, 96, 115, 128, 140, 159	DVDD		A	Positive Power for I/O, 3.3 V
182, 183, 195, 196, 208	VDDTS2		A	Positive Power for Analog Circuitry, 1.8 V
176, 189, 202	VCCAD		A	Positive Power for Analog Circuitry, 3.3 V

Table 15 Power and Ground (cont'd)

Ball No.	Name	Pin Type	Buffer Type	Function
7, 11, 21, 32, 39, 45, 53, 61, 69, 78, 77, 87, 93, 94, 103, 104, 111, 112, 126, 132, 138, 156, 157, 167	VSS		A	GND for Digital Circuit
205, 199, 192, 186, 179	VSSA		A	GND for Analog Circuitry
8	VCCPLL		A	Power for Phase Lock Loop, 1.8 V
1	VCCRG		A	Power for Regulator, 3.3 V
2	VCCBIAS		A	Power for BIAS, 3.3 V
4	GNDRG		A	Ground
173	AV33		A	Power for USB PHY, 3.3 V
170	AG33		A	Power for USB GND

2.1.16 Regulator Interface

Table 16 Regulator Interface

Ball No.	Name	Pin Type	Buffer Type	Function
5	VREF	AI	A	Reference Voltage Input This pin is used as the reference voltage for the regulator and generates the 1.8 V output from the 3.3 V power source.
6	CONTROL	A0	A	FET Control Output

2.1.17 Miscellaneous

Table 17 Miscellaneous

Ball No.	Name	Pin Type	Buffer Type	Function
152	TEST	I	TTL/PD	Test Pin This pin is for test purposes and should be connected to GND for normal operation.
153	RESET_N	I	TTL	System Reset Active low will initialize the chip to default state.
155	CLKO25M	O	PP	25MHz clock output
31	NC	NC		No connection

3 ADM5120P/PX System

Figure 3 shows the blocks of ADM5120P/PX. The blocks are broken down into:

- MIPS 4Kc
- Multi port memory controller
- USB 1.1 host controller
- UART controller
- Ether switch
 - SW2CPU DMA: this block handles the TX/RX packets from/to the CPU
 - Embedded data buffer
 - Embedded link table/MC table/addr. table
 - 802.3MAC and DMA
- 10/100 DSP PHY

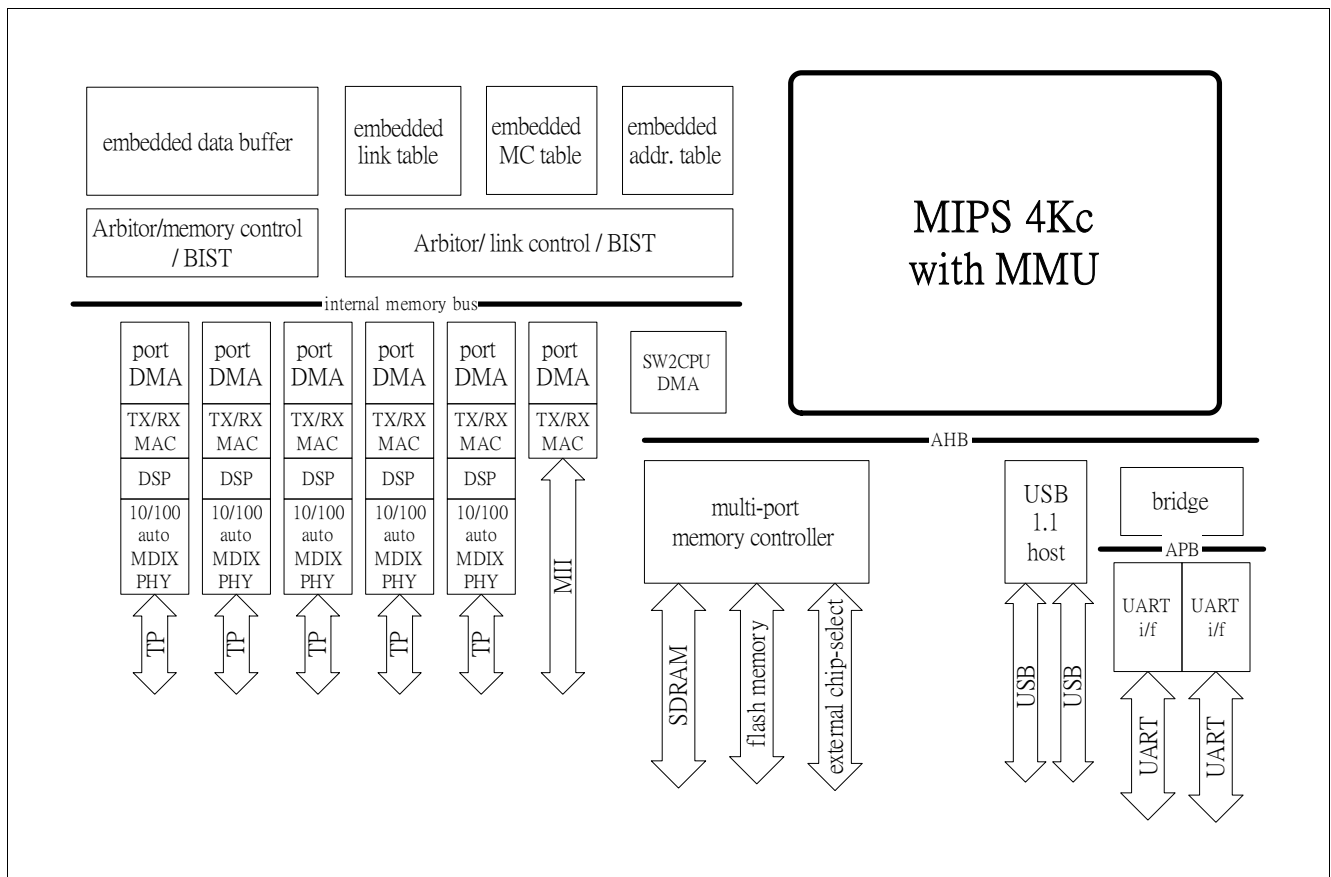

Figure 3 ADM5120P/PX Block Diagram

3.1 System Memory Map

Figure 4 shows the system memory allocation. The following lists a detailed reference for each allocation:

- Boot address is located in SRAM_0, for detailed information refer to [Chapter 5.2.1](#) Static memory controller
 - The address is fixed at 1FC0-0000_H and the maximum size is 4 Mbyte. The data-width is pin setting and register readable. The size is programmable.
- For external IO, ext_IO_0 and ext_IO_1 are also the generic SRAM space, refer to [Chapter 5.2.1](#) Static memory controller
- For SRAM_0, ext_IO_0 and ext_IO_1 the address and data width relation are
 - Byte access, address = [20:0], max size = 2 Mbytes

- 16-bit access, address = [21:1] (shift A0 out), max size = 4 Mbytes
- 32-bit access, address = [22:2] (shift A0, A1 out), max size = 8 Mbytes
- Use DQM to select the bytes
- SDRAM_0 is a generic SDRAM space, for detailed information refer to [Chapter 5.2.2](#) Dynamic memory controller
- MPMC is the Multi Port Memory controller which includes both the Static and the Dynamic memory controller. For detailed information refer to [Chapter 5](#) MPMC.
- USB 1.1 host controller, refer to the [Chapter 8](#) USB
- Switch part is Ether Switch which support 6 switch ports and one CPU DMA port. For detailed information refer to [Chapter 6](#) Switch
- There are two serial ports UART_0 and UART_1, refer to [Chapter 7](#) UART.
- INTC is an interrupt controller, for detailed information refer to [Chapter 3.2](#)

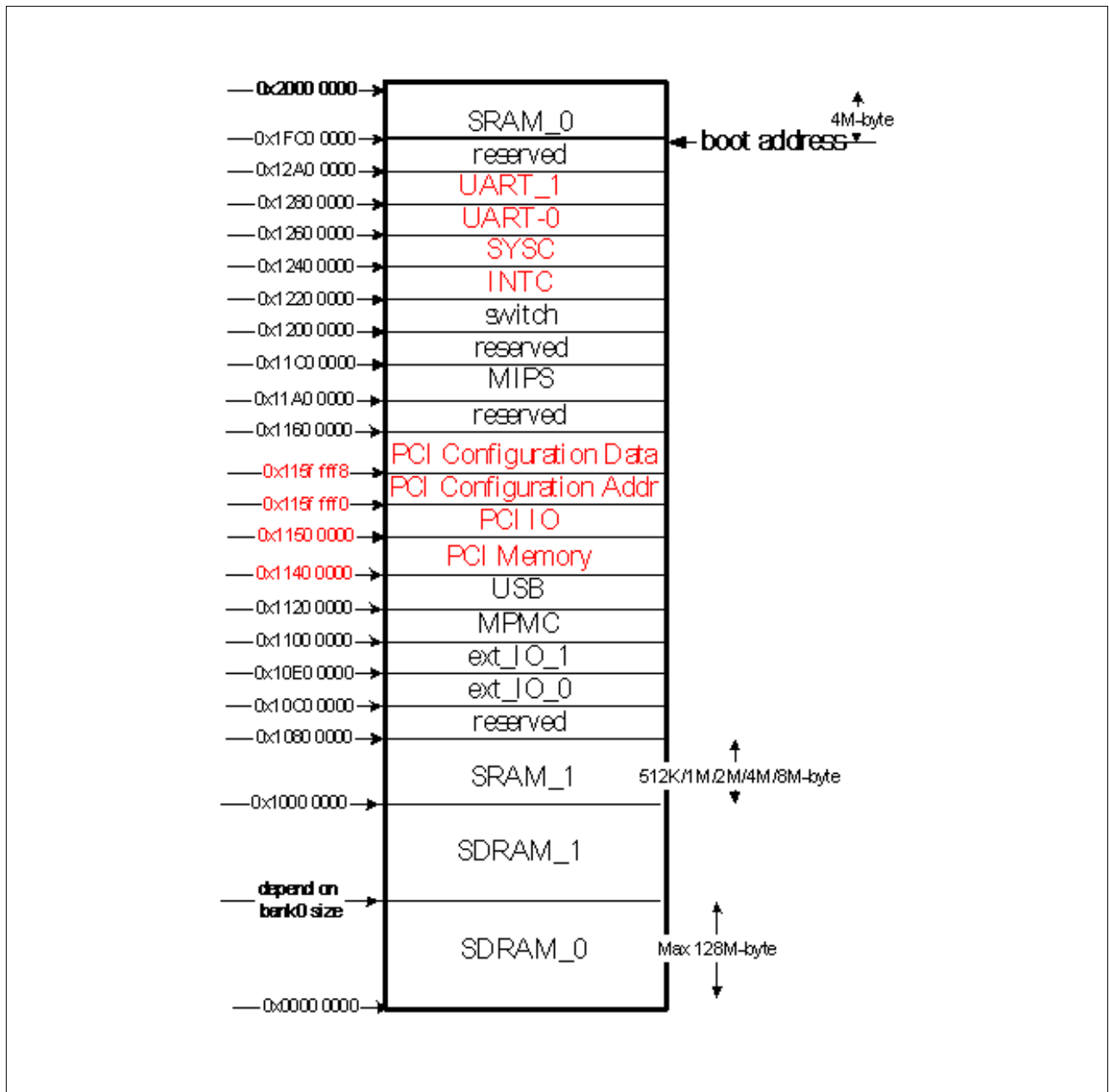

Figure 4 System Memory Map

3.1.1 Memory Mapping Notes

The following describes the memory mapping in detail:

3.2 System and Interrupt Registers Description

The following chapter describes both the system and the interrupt Registers.

Table 18 Registers Address Space

Module	Base Address	End Address	Note
Interrupt Control	1220 0000 _H	1220 0024 _H	–

Table 19 Registers Overview

Register Short Name	Register Long Name	Offset Address	Page Number
IRQS	Interrupt Request Status	00 _H	33
IRQRS	Interrupt Request Raw Status	04 _H	34
IRQE	Interrupt Request Enable	08 _H	34
IRQEC	Interrupt Request Enable Clear	0C _H	35
Res_0	Reserved 0	10 _H	36
INT_M	Interrupt Mode	14 _H	36
FIQ_S	Fast Interrupt Request Status	18 _H	36
IRQ_TS	Interrupt Request Test Source	1C _H	37
IRQSS	Interrupt Request Source Sel	20 _H	38
INT_L	Interrupt Level	24 _H	38

The register is addressed wordwise.

Table 20 Registers Access Types

Mode	Symbol	Description Hardware (HW)	Description Software (SW)
Basic Access Types			
read/write	rw	Register is used as input for the HW	Register is read and writable by SW
read/write virtual	rvv	Physically, there is no new register in the generated register file. The real readable and writable register resides in the attached hardware.	Register is read and writable by SW (same as rw type register)
read	r	Register is written by HW (register between input and output -> one cycle delay)	Value written by SW is ignored by HW; that is, SW may write any value to this field without affecting HW behavior
read only	ro	Same as r type register	Same as r type register
read virtual	rv	Physically, there is no new register in the generated register file. The real readable register resides in the attached hardware.	Value written by SW is ignored by HW; that is, SW may write any value to this field without affecting HW behavior (same as r type register)
write	w	Register is written by software and affects hardware behavior with every write by software.	Register is writable by SW. When read, the register does not return the value that has been written previously, but some constant value instead.
write virtual	wv	Physically, there is no new register in the generated register file. The real writable register resides in the attached hardware.	Register is writable by SW (same as w type register)
read/write hardware affected	rwh	Register can be modified by hardware and software at the same time. A priority scheme decides, how the value changes with simultaneous writes by hardware and software.	Register can be modified by HW and SW, but the priority SW versus HW has to be specified. SW can read the register.

Table 21 Registers Clock Domains

Clock Short Name	Description
-	-

3.2.1 Interrupt Control Register Map

The interrupt controller supports level sensitivity. The external input level can be programmed as active high or low.

Interrupt register description:

Interrupt Request Status

IRQS **Offset** **Reset Value**
Interrupt Request Status **00_H** **0_H**

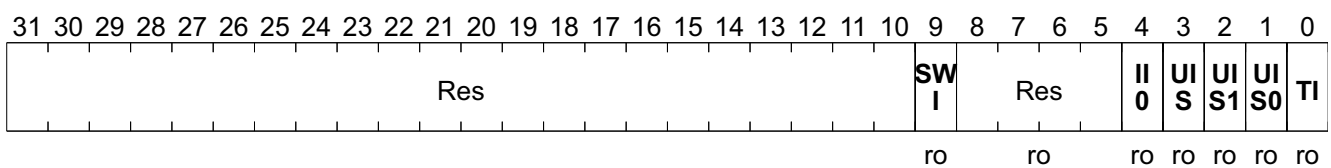

Field	Bits	Type	Description
Res	31:10		Reserved
SWI	9	ro	Switch Interrupt status after mask Switch interrupt, refer to switch registers offset 0xB0 and 0xB4 for more detail.
Res	8:5	ro	Reserved
IIO	4	ro	Internal Interrupt 0 status after mask Internal interrupt 0, refer to switch registers offset 0xBC bit[4] for more detail. pin GPIO 2 is the source.
UIS	3	ro	USB Interrupt Source status after mask
UIS1	2	ro	UART1 Interrupt Source status after mask
UIS0	1	ro	UART0 Interrupt Source status after mask
TI	0	ro	Timer Interrupt status after mask Timer interrupt, refer to switch registers offset 0xF0 and 0xF4 for more detail.

Interrupt Request Raw Status

IRQRS **Offset**
Interrupt Request Raw Status **04_H** **Reset Value**
0_H

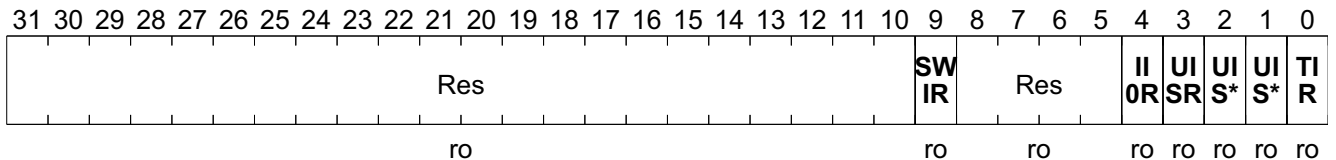

Field	Bits	Type	Description
Res	31:10	ro	Reserved
SWIR	9	ro	Switch Interrupt Raw status The Switch interrupt status before masking. refer to switch registers offset 0xB0 and 0xB4 for more detail.
Res	8:5	ro	Reserved
IIR	4	ro	Internal Interrupt 0 Raw status Internal interrupt 0, refer to switch registers offset 0xBC bit[4] for more detail. pin GPIO 2 is the source.
UISR	3	ro	USB Interrupt Raw Status
UIS1R	2	ro	UART1 Interrupt Raw status
UIS0R	1	ro	UART0 Interrupt Raw status
TIR	0	ro	Timer Interrupt Raw status Timer interrupt, refer to switch registers offset 0xF0 and 0xF4 for more detail.

Interrupt Request Enable

IRQE **Offset**
Interrupt Request Enable **08_H** **Reset Value**
0_H

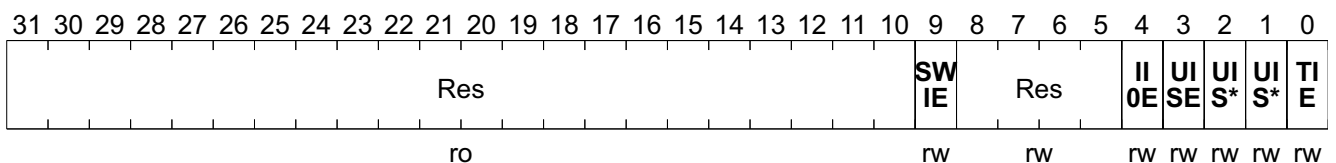

Field	Bits	Type	Description
Res	31:10	ro	Reserved Not Applicable.

Field	Bits	Type	Description
SWIE	9	rw	Switch Interrupt Enable The enable register is used to mask the switch interrupt source. 0 _B No effect 1 _B Enable the interrupt and allow the interrupt request to MIPS
Res	8:5	rw	Reserved
IIOE	4	rw	Internal Interrupt 0 Enable The enable register is used to mask the GPIO 2 interrupt source. 0 _B No effect 1 _B Enable the interrupt and allow the interrupt request to MIPS
UISE	3	rw	USB Interrupt Enable The enable register is used to mask the USB interrupt source. 0 _B No effect 1 _B Enable the interrupt and allow the interrupt request to MIPS
UIS1E	2	rw	UART1 Interrupt Enable The enable register is used to mask the UART 1 interrupt source. 0 _B No effect 1 _B Enable the interrupt and allow the interrupt request to MIPS
UIS0E	1	rw	UART0 Interrupt Enable The enable register is used to mask the UART 0 interrupt source. 0 _B No effect 1 _B Enable the interrupt and allow the interrupt request to MIPS
TIE	0	rw	Timer Interrupt Enable The enable register is used to mask the Timer interrupt source. refer to B+F0 and B+F4. 0 _B No effect 1 _B Enable the interrupt and allow the interrupt request to MIPS

Interrupt Request Enable Clear

IRQEC	Offset	Reset Value
Interrupt Request Enable Clear	0C_H	0_H

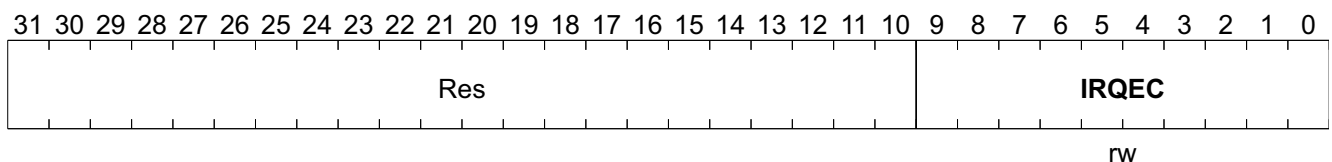

Field	Bits	Type	Description
Res	31:10		Reserved Not Applicable.
IRQEC	9:0	rw	IRQ Enable Clear 9:0 This clears the bits of the IRQ_enable. 0 _B No effect 1 _B Clear the corresponding bit of IRQ_enable

Reserved 0

Res_0 **Offset** **Reset Value**
Reserved 0 **10_H** **0_H**

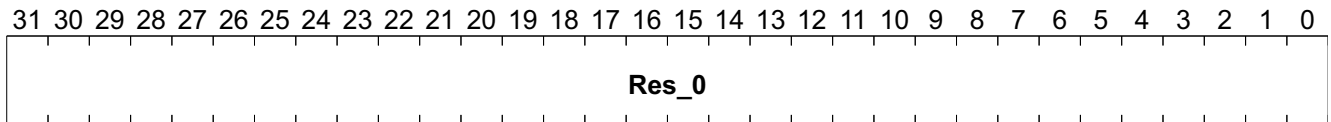

Field	Bits	Type	Description
Res_0	31:0		Reserved Not Applicable.

Interrupt Mode

INT_M **Offset** **Reset Value**
Interrupt Mode **14_H** **0_H**

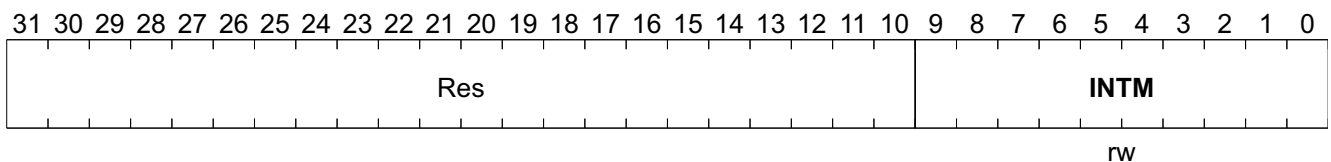

Field	Bits	Type	Description
Res	31:10		Reserved Not Applicable.
INTM	9:0	rw	INT Mode 9:0 The interrupt type of the interrupt sources. 0 _B The corresponding Interrupt port generates the IRQ to MIPS 1 _B The corresponding Interrupt port generates the FIQ to MIPS

Fast Interrupt Request Status

FIQ_S **Offset** **Reset Value**
Fast Interrupt Request Status **18_H** **0_H**

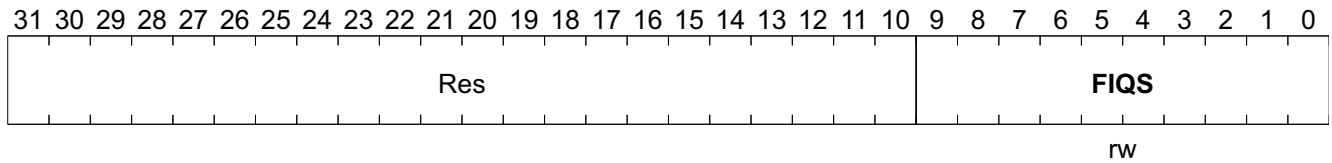

Field	Bits	Type	Description
Res	31:10		Reserved Not Applicable.
FIQS	9:0	rw	FIQ Status 9:0 The status of the fast interrupt sources after masking. 1 _B The corresponding IRQ is active, and generates the interrupt to MIPS

Interrupt Request Test Source

IRQ_TS	Offset	Reset Value
Interrupt Request Test Source	1C_H	0_H

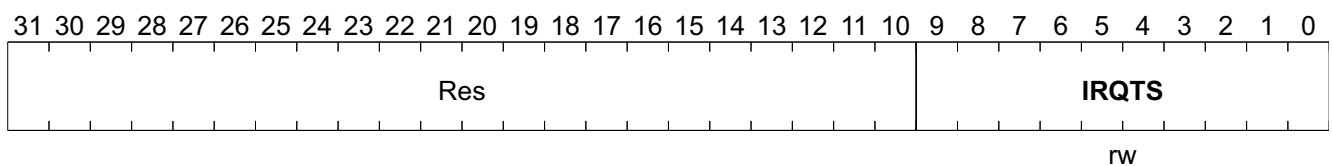

Field	Bits	Type	Description
Res	31:10		Reserved Not Applicable.
IRQTS	9:0	rw	IRQ Test Source 9:0 The test data for the IRQ_raw_status.

Interrupt Request Source Sel

IRQSS **Offset**
Interrupt Request Source Sel **20_H** **Reset Value**
0_H

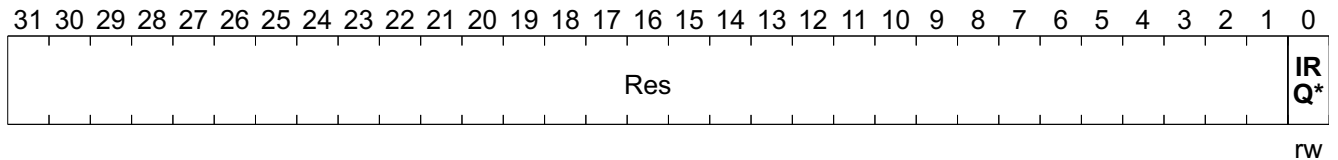

Field	Bits	Type	Description
Res	31:1		Reserved Not Applicable.
IRQSS	0	rw	IRQ Source Selection 1 _B Load the IRQ_test_source into IRQ_raw_status

Interrupt Level

INT_L **Offset**
Interrupt Level **24_H** **Reset Value**
1C8_H

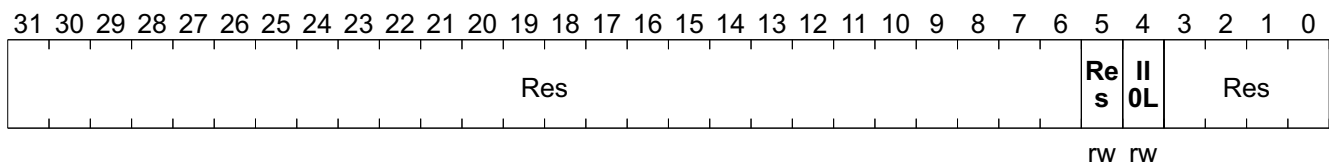

Field	Bits	Type	Description
Res	31:6		Reserved Not Applicable.
Res	5	rw	Reserved Not Applicable.
IIOL	4	rw	Internal Interrupt 0 Level Level specify for GPIO 2 interrupt source. 0 _B Active high (default) 1 _B Active low
Res	3:0		Reserved Not Applicable.

4 Main Processor

The CPU description covers:

1. Feature list ([Chapter 4.1](#))
2. Functional description ([Chapter 4.2](#))

4.1 4Kc CPU Core Features

The 4Kc CPU supports:

- 32-bit Data and Address Paths
- MIPS32™ Compatible Instruction Set
 - All MIPS II™ Instructions
 - Multiply-Add and Multiply-Subtract Instructions (MADD, MADDU, MSUB, MSUBU)
 - Targeted Multiply Instruction (MUL)
 - Zero and One Detect Instructions (CLZ, CLO)
 - Wait Instruction (WAIT)
 - Conditional Move Instructions (MOVZ, MOVN)
 - Prefetch Instructions (PREF)
- MIPS16e Application Specific Extension
 - 16 bit encoding of 32 bit instructions to improve code density
 - Special PC relative instructions for efficient loading of addresses and constants
 - Data type conversion instructions (ZEB, SEB, ZEH, SEH)
 - Compact Jumps (JRC, JALRC)
 - Stack frame set-up and tear down “macro” instructions (SAVE and RESTORE)
- Instruction and Data Cache
 - 8 KByte Instruction Cache Size in a 4-Way set associative organization
 - 4 KByte Data Cache Size in a 2-Way set associative organization
 - Loads that miss in the cache are blocked only until the critical word is available
 - Supports Write-back with write-allocation and Write-through with or without write- allocation
 - 16-byte cache line size, word sectored
 - Virtually indexed, physically tagged
 - Support for cache line locking
 - Non-blocking prefetches
- MIPS32™ privileged resource architecture
 - Count/Compare registers for real-time timer interrupts
 - Instruction and Data watch registers for software breakpoints
 - Separate interrupt exception vector
- Memory Management Unit
 - 16 dual-entry MIPS32 style JTLB with variable page sizes
 - 4-entry instruction micro TLB
 - 4-entry data micro TLB
- Core Bus Interface Unit (Core BIU)
 - All I/Os fully registered
 - Separate, unidirectional 32-bit address and data buses
 - Two 16 Byte collapsing write buffers
- Multiply Divide Unit
 - Maximum issue rate of one 32 x 16 multiply per clock
 - Maximum issue rate of one 32 x 32 multiply every other clock

- Early-in divide control. Minimum 11, maximum 34 clock cycles
- Power Control
 - No minimum clock frequency
 - Power Down mode (triggered by WAIT instruction)
 - Support for software controlled clock divider
- EJTAG Debug Support
 - CPU control with start, stop and single-step feature
 - Software Breakpoints via SDBBP instruction
 - Hardware Breakpoints on virtual addresses
 - Test Access Port (TAP) facilitates high speed download of application
 - Optional EJTAG Trace hardware to enable real-time tracing of executed code

4.2 Functional Description

The block diagram of the main processor subsystem is given in [Figure 5](#).

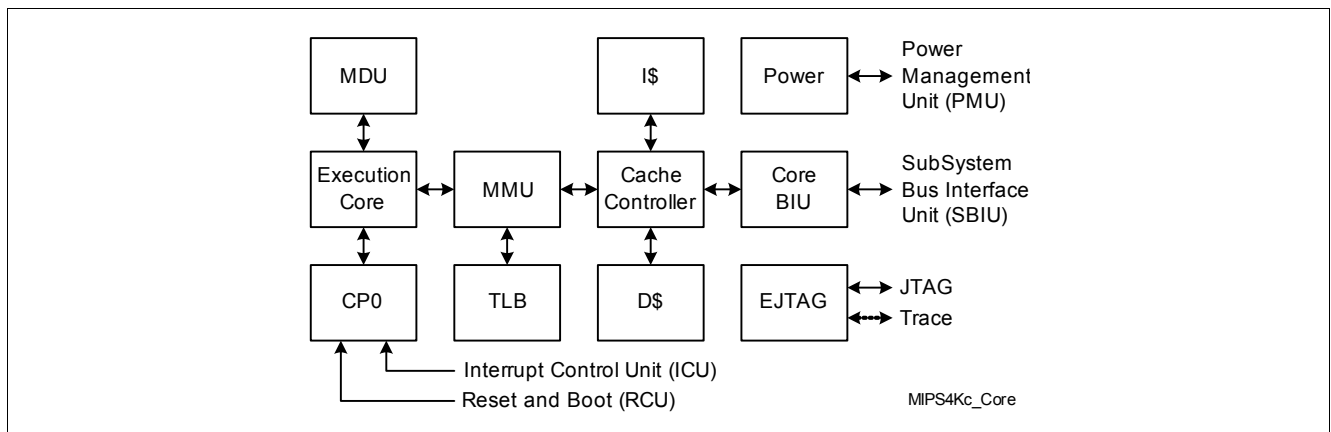

Figure 5 Main Processor Subsystem

The main processor subsystem consists of the below major parts :

- The MMU enabled MIPS 4Kc core and associated cache system
- The bus wrapper block translates the MIPS 4Kc EC bus to the system bus

4.2.1 Endianness Mode

The main processor sub-system is capable of running in either big endian or little endian mode. By default, it is set to little endian mode. It can be switched to big endian mode by pin strapping the signal : ADDR[19](Pin 119).

Table 22 Endian Setting

Signal ADDR[19]	Mode
1	Big Endian
0	Little Endian (default)

4.2.2 Coprocessor CP0

In the MIPS architecture, the System Control Coprocessor (CP0) is responsible for the virtual-to-physical address translation, cache protocols, exception control system, processor’s diagnostics capability, the operating mode selection (Kernel, Supervisor, User, and Debug) and the enabling/disabling of interrupts. Information such as CPU status, performance and configuration (including caches) are available by accessing the CP0 registers.

4.2.3 Execution Unit

The 4Kc™ core execution unit implements a load/store architecture with single-cycle ALU operations (logical, shift, add, subtract). The 4Kc™ core contains thirty-two 32-bit general-purpose registers used for scalar integer operations and address calculation. The register file consists of two read ports and one write port and is fully bypassed to minimize operation latency in the pipeline.

The execution unit includes:

- 32-bit adder used for calculating arithmetic results and the data addresses
- Address Unit for calculating the next instruction address
- Logic for branch determination and branch target address calculation
- Load aligner
- Bypass multiplexers used to avoid stalls when executing instructions streams where data producing instructions are followed closely by consumers of their results
- Zero/One detect unit for implementing the Count Leading Zero/One (CLZ, CLO) instructions
- Logic unit for performing bitwise logical operations
- Shifter & Store Aligner

4.2.4 Multiply Divide Unit

The multiply divide unit (MDU) performs multiply and divide operations. The pipeline MDU supports execution of a 16:16 or a 32:16 on every clock cycle. 32:32 multiply operations can be issued every other clock cycle. Divide operations are implemented with a 1-bit per clock iterative algorithm and requires 35 clock cycles in worst case to complete. Early-in, the algorithm detects sign extensions of the dividend, reducing the amount of iterations. An attempt to issue subsequent MDU instruction while a divide is still active, causes a pipeline stall until the divide operation is completed.

The MUL instruction specifies that the lower 32 bits of the multiply result is placed in the register file instead of the HI/LO register pair. By avoiding the explicit move from LO (MFLO) instruction, required when using the LO register, and by supporting multiple destination registers, the throughput of multiplication intensive operations is increased. The multiply add (MADD, MADDU) and multiply subtract (MSUB, MSUBU) are used to perform the multiply add and multiply subtract operations, which are commonly used in Digital Signal Processing (DSP) algorithms.

4.2.5 Memory Management Unit

The Memory Management Unit (MMU) of the MIPS 4Kc™ CPU is implemented as a Translation Lookaside Buffer (TLB). The MMU translates any virtual address to a physical address as well as providing memory protection mechanisms.

The MIPS 4Kc™ CPU supports three operating modes: the User Mode, the Kernel Mode and the Debug Mode. User Mode is often used for application programs. Kernel Mode is typically used for operating system tasks. Debug Mode is used for software debugging purposes.

The address translation performed by the MMU depends on the mode in which the processor is operating. The 4 Gbyte virtual memory space addressed by a 32-bit virtual address is segmented differently depending on the mode of operation (user, kernel, debug). Each of the segments are either mapped or unmapped. Mapped segments use the TLB to translate from virtual to physical addresses, while the unmapped segments have a fixed simple translation.

4.2.6 Cache System

The CPU Core incorporates both on-chip instruction and data caches that can each be accessed in a single processor cycle.

- 8 Kbyte of instruction and an 8 KByte data cache
- Instruction organized as 2-way set associative organization
- Data cache organized as 2-way set associative organization

- Each cache has its own 32-bit data path, both caches can be accessed in the same pipeline clock cycle
- Single processor cycle access
- 16 byte cache line size, word sectored
- Cache locking on a per line basis, CACHE instruction to manipulate the Data and Tag arrays of the instruction as well as the data cache, including cache line locking
- Virtually indexed and physically tagged virtual to physical address translation occurs in parallel with the cache access
- Hit under refill
- Support of streaming instruction or data is forwarded during cache refill
- Non blocking prefetches
- PREF instructions are supported by the data cache controller, which are used to increase the performance by polling the processor
- Non blocking loads
- Supports Write-back with write-allocation and Write-through with or without write- allocation

4.2.7 EJTAG Debug Unit

All cores provide basic EJTAG support with debug mode, run control, single step and software breakpoint instruction (SDBBP) as part of the core. These features allow for the basic software debug of user and kernel code.

Additional EJTAG features include:

- Hardware breakpoints: The hardware instruction breakpoints can be configured to generate a debug exception, when an instruction is executed anywhere in the virtual address space. Bit mask and Address Space Identifier (ASID) values may apply in the address compare. These breakpoints are not limited to code in RAM like the software instruction breakpoint (SDBBP). The data breakpoints can be configured to generate a debug exception on a data transaction. The data transaction may be qualified with both virtual address, data value, size and load/store transaction type. Bit mask and ASID values may apply in the address compare, and byte mask may apply in the value compare.
- A TAP, enabling communication between an EJTAG probe and the CPU through a dedicated port. This provides the possibility for debugging without debug code in the application, and for download of application code to the system.
- An optional block is EJTAG Trace which enables real-time tracing capability. The trace information can be stored to (either an on-chip trace memory, or to) an off-chip trace probe. The trace of program flow is highly flexible and can include instruction program counter as well as data addresses and data values. The trace features provides a powerful software debugging mechanism.

4.3 Register Description

The internal registers are for dug purpose only.

The register description is splitted into Bus Interface Unit (BIU) and FPI-Bus 0 (FB),

4.3.1 BIU Registers

Absolute Register Address = Module Base Address + Offset Address

Table 23 Module Base Address - BIU

Module Name	Base Address	End Address
BIU	1FA8 0000 _H	1FAF FFFF _H

Table 24 Registers Overview Registers Overview from Chapter **BIU Registers**

Register Short Name	Register Long Name	Offset Address	Page Number
BIU_ID	Bus Interface Identification Register	0000 _H	
BIU_ERRCAUSE	BIU Error Cause Register	0100 _H	
BIU_ERR_ADDR	BIU Error Address Register	0108 _H	
BIU_AUXI	BIU Auxillary Port Input Register	0200 _H	
BIU_AUXO	BIU Auxillary Port Output Register	0208 _H	

The register is addressed wordwise.

4.3.1.1

BIU Identification Register

Register **BIU_ID** holds module identification and the revision of the Subsystem BIU module.

BIU_ID	Offset	Reset Value
Bus Interface Identification Register	0000_H	0000 0900_H

Field	Bits	Type	Description
ARCH	16	r	Architecture This bit identifies if the internal architecture of the logic block is either 64 bit or 32 bit. 0 _B 32-bit internal architecture. 1 _B 64-bit internal architecture.
ID	15:8	r	Identification Value This bit field identifies the logic block of the CPU Subsystem. It is used as manufacturer identification code only.
REV	7:0	r	Revision Number The first revision starts with 00 _H

BIU Access Error Log Register (Error Cause)

The error cause log register holds log information about a detected write error. When the BIU detects an illegal write access the cause of error is logged in this register and its address is logged in the **BIU_ERR_ADDR** register. When the ERR register bit is set, an interrupt is generated to the CPU. While the ERR bit is set no new errors are logged, and new errors are therefore ignored, until this bit has been cleared by the CPU. An illegal address error is reported in the CAUSE field when an access is issued to a reserved memory area, non-existing SRAM memory

or a non-existing register in the BIU or RAM register area. An illegal access error is reported when the BIU detects a non-word access to a defined register area.

Note: Please note that an interrupt is generated if the CPU writes a 1 to the ERR bit. This should only be used for test. For normal operation the CPU will clear this bit in response to hardware setting it.

BIU_ERRCAUSE	Offset	Reset Value
BIU Error Cause Register	0100_H	0000 0000_H

Field	Bits	Type	Description
ERR	31	rw	Error log bit 0 _B No Error No error logged 1 _B Error logged Error logged
PORT	19:16	rw	Port number of the access Initiator <i>Note: Others are reserved.</i> 0 _B CPU CPU to BIU
CAUSE	1:0	rw	Error Cause The CAUSE field indicates the cause of error according to the list below: <i>Note: Others are reserved.</i> 00 _B Reset Reset State 01 _B Illegal address error caused by Illegal address 11 _B Illegal Access error caused by Illegal access

Bus Interface Unit Error Address

The accessed address error log register holds the address of a detected write error. When the Subsystem BIU detects an illegal write (e.g. none existing address) the address is logged in this register and the cause of error is logged in the **BIU_ERRCAUSE** register. The register can be written by the CPU but for normal operation the CPU will only read it in response to an error.

BIU_ERR_ADDR	Offset	Reset Value
BIU Error Address Register	0108_H	0000 0000_H

Field	Bits	Type	Description
ADDR	31:0	rw	Address of logged illegal access Returns the illegal address.

Bus Interface Auxillary Port Input

Returns the confirmation that the SIF was flushed.

BIU_AUXI	Offset	Reset Value
BIU Auxillary Port Input Register	0200_H	0000 0000_H

Field	Bits	Type	Description
ACK	0	r	SIF Flush ACK Returns the acknlowdgement that the SIF was flushed. 0 _B No action 1 _B Flushed SIF was flushed.

Bus Interface Unit Auxillary Port Output

Used to configure the basic parameters of the BIU.

BIU_AUXO	Offset	Reset Value
BIU Auxillary Port Output Register	0208_H	0000 0000_H

Field	Bits	Type	Description
max_read_ws	15:8	rw	Read WS define number of waitstates for read
Sus	4	rw	OCDS suspend should written with 0
Ndt	3	rw	delayed transaction should written with 1
Ewa	2	rw	early_wr_abotr_sup should written with 0
Era	1	rw	early_rd_abort_sup should written with 0
SFR	0	rw	SIF Flush request request flush operation from SIF module

4.3.2 FPI Bus Register Description

Absolute Register Address = Module Base Address + Offset Address

Table 25 Module Base Address

Module Name	Base Address	End Address
FB	1F88 0000 _H	1F8F FFFF _H

 Table 26 Registers Overview Registers Overview from Chapter [FPI Bus Register Description](#)

Register Short Name	Register Long Name	Offset Address	Page Number
FB_ID	FPI Bus Identification Register	0000 _H	
FB_ERRCAUSE	FPI Bus Brodge Error Cause Register	0100 _H	
FB_ERR_ADDR	FPI Bus Error Address Register	0108 _H	
FB_CFG	FPI Bus Bridge Configuration Register	0800 _H	

The register is addressed wordwise.

4.3.2.1

FPI Bus Bridge Identification Register

Register [FB_ID](#) holds information about the FPI-Bus Bridge module.

FB_ID	Offset	Reset Value
FPI Bus Identification Register	0000 _H	0000 0800 _H

Field	Bits	Type	Description
ID	15:8	rw	Identification Identification number of the FPI Bus Bridge
REV	7:0	rw	Revision Indicates the revision of the module. The first revision is 00 _H

FPI Bus Error Address

Register [FB_ERR_ADDR](#) holds the address of a detected write error. When the CPU port of the FPI-Bus Bridge detects an illegal write, the address is logged in register [FB_ERR_ADDR](#) and the cause of error is logged in register [FB_ERRCAUSE](#).

FB_ERR_ADDR	Offset	Reset Value
FPI Bus Error Address Register	0108 _H	0000 0000 _H

Field	Bits	Type	Description
ADDR	31:0	rw	Address of logged illegal access Resturns the logged illegal address.

FPI Bus Bridge Configuration Register

The FPI Bus bridge configuration register controls the supervisor bit used for the FPI master interface commands. The reset value is SVM = 1, i.e. the FPI-Bus is accessed in Supervisor mode after reset.

FB_CFG	Offset	Reset Value
FPI Bus Bridge Configuration Register	0800_H	0000 0001_H

Field	Bits	Type	Description
SVM	0	rw	Supervisor/User mode Configures the supervisor/user mode. 0 _B User operates in User mode 1 _B Supervisor operates in Supervisor mode

FPI Bus Bridge Access Error log Register (Error Cause)

Register **FB_ERRCAUSE** holds log information about a detected write error. When the CPU port of the FPI-Bus Bridge detects an illegal write, the cause of error is logged in register **FB_ERRCAUSE** and its address is logged in the **FB_ERR_ADDR** register. When the ERR register bit is set, an interrupt to the CPU is issued. While the ERR bit is set, no new errors are logged, hence new errors are ignored until this bit has been cleared by the CPU on write action.

FB_ERRCAUSE	Offset	Reset Value
FPI Bus Brodge Error Cause Register	0100_H	0000 0000_H

Field	Bits	Type	Description
ERR	31	rw	Error log bit 0 _B No Error No error logged 1 _B Error Error logged
PORT	19:16	rw	Port Number of the Access Initiator Bit field PORT holds the port number of the access initiator in case of an access error. 0100 _B FPI Bus Bridge port number of FPI Bus bridge

Field	Bits	Type	Description
CAUSE	1:0	rw	<p>Error Cause</p> <p>The CAUSE field indicates the cause of error.</p> <p>00_B Reset Reset State</p> <p>01_B Illegal Address error caused by Illegal address An illegal address error occurs on a write operation outside the address range used for the FPI-Bus Bridge registers</p> <p>10_B Illegal Access error caused by Illegal access An illegal access error occurs on a write operation with illegal byte lane configuration</p> <p>11_B Reserved reserved</p>

5 MultiPort Memory Controller (MPMC)

The MultiPort Memory Controller (MPMC) description covers:

- Feature list ([Chapter 5.1](#))
- Functional description ([Chapter 5.2](#))
- External Interface; described in the dedicated chapter of the different interfaces
- Registers ([Chapter 5.3](#))

5.1 Feature List

The MPMC offers the following features:

- Dynamic memory interface support including SDRAM, JEDEC low-power SDRAM
- Asynchronous static memory device support including SRAM, ROM and NOR Flash with or without asynchronous page mode
- Read and write buffers to reduce latency and to improve performance
- 8-bit, 16-bit and 32-bit wide static memory support
- Static memory features include:
 - Programmable wait states
 - Output enable, and write enable delays
 - Extended wait
 - Bus turnaround delay
 - Asynchronous page mode read
- Controller supports 2K, 4K and 8K row address synchronous memory parts. That is typical 512M, 256M, 128M and 16MB parts with 8, 16 or 32DQ bits per device.

5.2 Functional Description

The following describes the MPMC's functions

5.2.1 Static Memory Controller

Static memory descriptions:

5.2.1.1 Extended Wait Transfers

The static memory controller supports extremely long transfer times. In normal use the memory transfers are timed using the [MPMC Static Wait Rd 1](#) and [MPMC Static Wait Wr 1](#) registers. These registers enable transfers with up to 32 wait states. However, if an extremely slow static memory device has to be accessed you can enable the Extended Wait(EW) bit in register . When this bit is enabled the [MPMC Static Extended Wait](#) register is used to time both the read and write transfers. This register enables transfers to have up to 16368 wait states.

5.2.1.2 Wait State Generation

Each bank of the MPMC must be configured for external transfer wait states in read and write accesses. This is achieved by programming the appropriate fields of the bank control registers:

- [MPMC Static Wait Wen 1](#)
- [MPMC Static Wait Oen 1](#)
- [MPMC Static Wait Rd 1](#)
- [MPMC Static Wait Wr 1](#)
- [MPMC Static Wait Page 1](#)
- [MPMC Static Wait Turn 1](#)
- [MPMC Static Extended Wait](#)

The number of cycles in which an AMBA transfer completes is controlled by two additional factors:

- Access width
- External memory width

5.2.1.3 Static Memory Read Control

The static memory read controls are described in the following:

- The delay between the assertion of the chip select and the output enable is programmable from 0 to 15 cycles using the WAITOEN bits of the **MPMC Static Wait Oen 1** registers. The output enable is always deasserted at the same time as the chip select, at the end of the transfer. **Figure 6** shows that the WAITOEN is set to 2 in the **MPMC Static Wait Oen 1** registers.
- The read access time is determined by the number of wait states programmed for the WAITRD field of the **MPMC Static Wait Rd 1** register. The WAITTURN field in the **MPMC Static Wait Turn 1** register determines the minimum number of bus turnaround wait states added between external read and write transfers. **Figure 7** shows that the WAITRD is set to 2 in the **MPMC Static Wait Rd 1** register.
- The MPMC supports asynchronous page mode read up to four memory transfers by updating address bits A[1] and A[0]. This feature increases the bandwidth by using a reduced access time for the read accesses that are in page mode. The first read access takes **MPMC Static Wait Rd 1** and WAITRD cycles. Subsequent read accesses that are in page mode take **MPMC Static Wait Page 1** and WAITPAGE cycles. The chip select and output enable lines are held during the burst, and only the lower two address bits change between subsequent accesses. At the end of the burst the chip select and output enable lines are deasserted together. The **Figure 8** shows the page mode read with 2 WAITRD cycles and 1 WAITPAGE cycle.

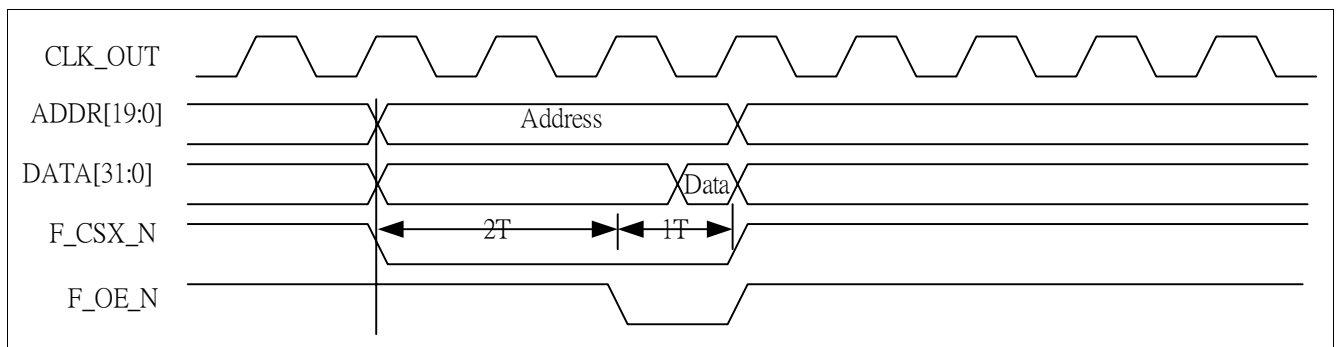

Figure 6 Read with Two Clock Delay for Read Enable

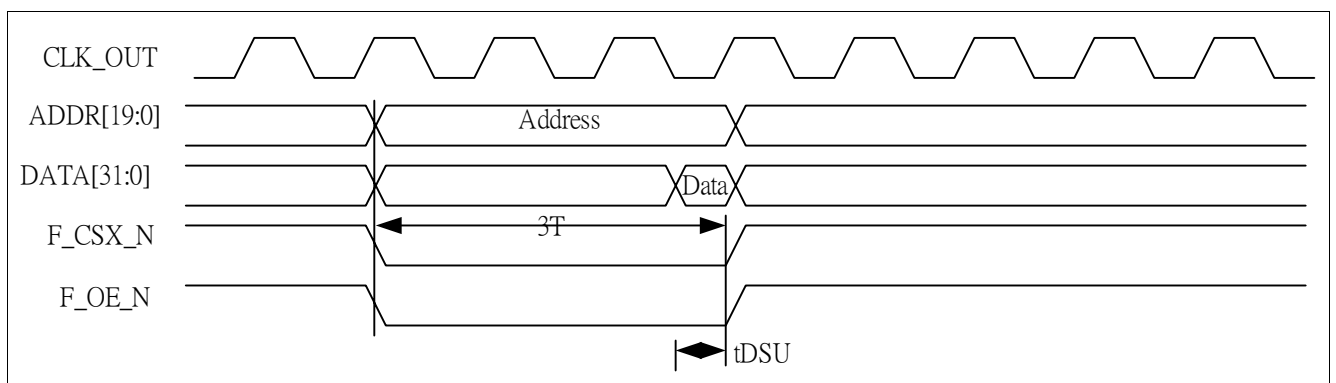

Figure 7 Read with Two Wait State

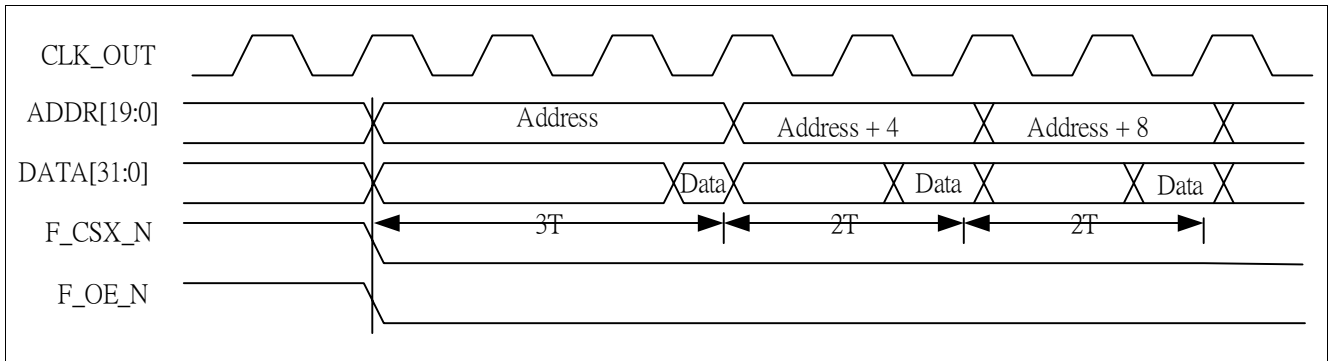

Figure 8 Asynchronous Page Mode Read with 2 Wait State and 1 Sequential Wait State

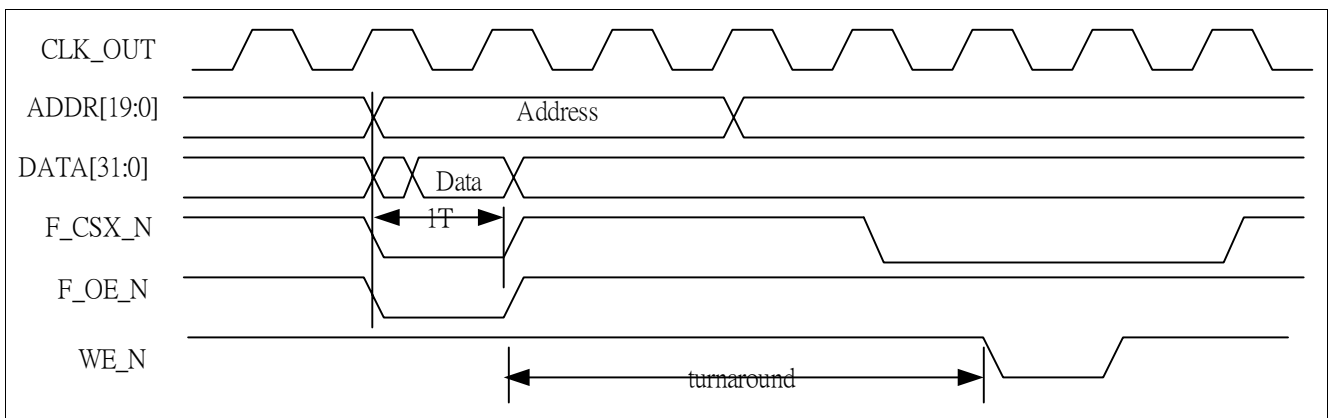

Figure 9 Bus Turnaround

5.2.1.4 Static Memory Write Control

Write timing is described in the following:

- The delay between the assertion of the chip select and the write enable is programmable from 0 to 15 cycles using the WAITWEN bits of the **MPMC Static Wait Wen 1** registers. The write enable is asserted on the rising edge of MPMCCLK after the assertion of the chip select for the zero wait state. The write enable is always deasserted a cycle before the chip select, at the end of the transfer.
- The write access time is determined by the number of wait states programmed for the WAITWR field of the **MPMC Static Wait Wr 1** register. The WAITTURN field in the **MPMC Static Wait Turn 1** register determines the number of bus turnaround wait states added between external read and write transfers.

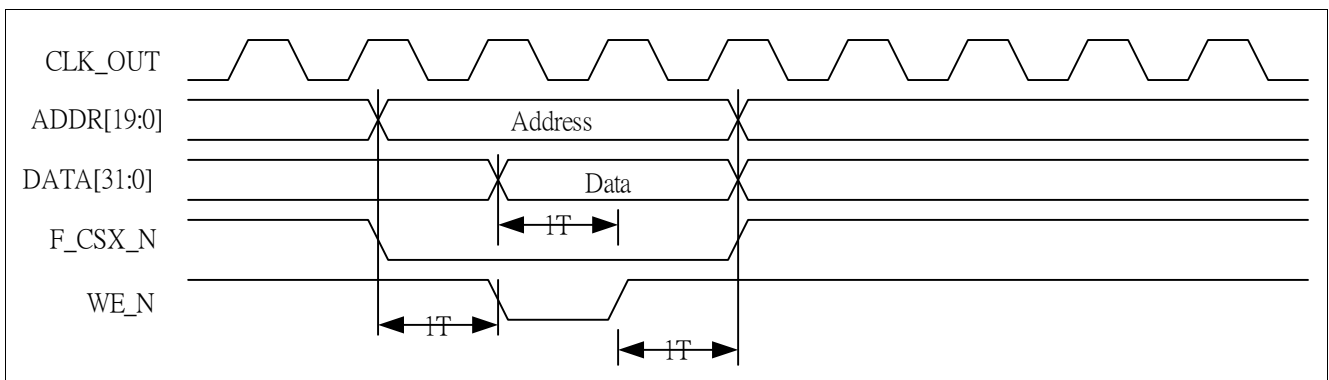

Figure 10 Write with Zero Wait State

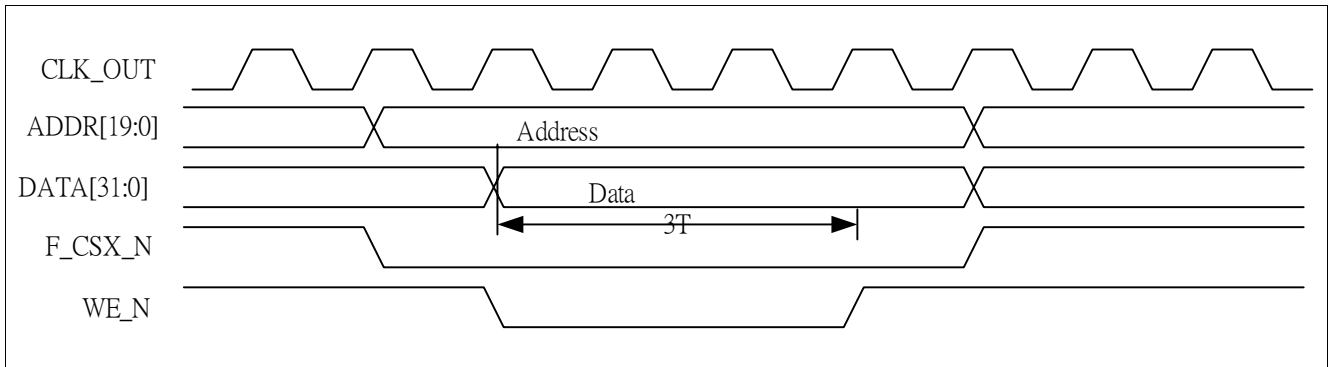

Figure 11 Write with Two Wait State

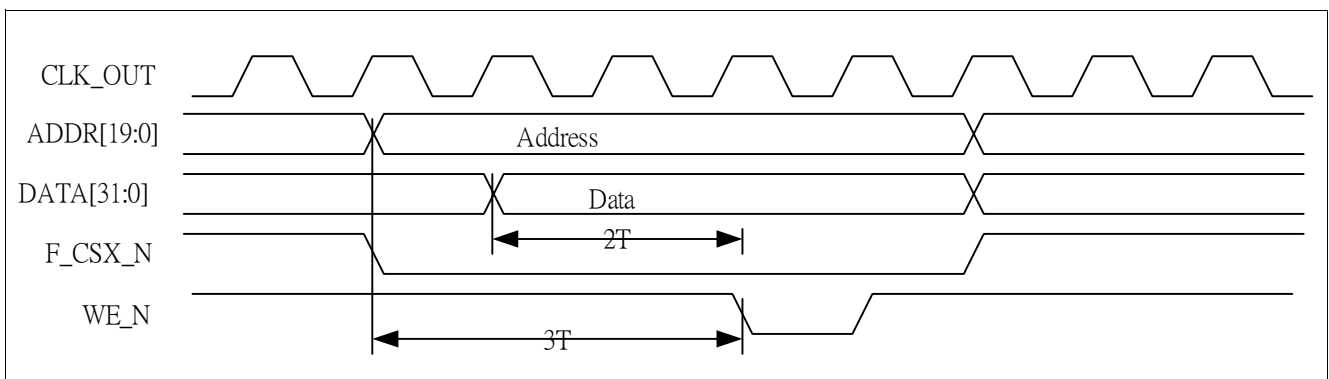

Figure 12 Write with Two Clock Delay for Write Enable

5.2.2 Dynamic Memory Controller

The following describes the Dynamic Controller.

5.2.2.1 Dynamic Memory Controller Command Descriptions

The dynamic memory controller block in MPMC supports the SDRAM memory commands shown in list below:

- ACT: Opens an SDRAM row
- REF: CAS before RAS style refresh
- SREF: self-refresh
- PRE: Pre-charge, close a bank
- RD: Read from an open row, row left open
- WR: Write to an open row, row left open
- RDA: Read followed by pre-charge
- WRA: Write followed by pre-charge

The commands listed above are generated automatically.

The commands in the list below are generated under software control by programming the SDRAM initialization and deep sleep mode fields of the [MPMC Dynamic Control](#) register.

- MRS: Mode register set, programs SDRAM mode register
- NOP: No operation, used during the SDRAM initialization sequence
- PALL: Pre-charge all, used during the SDRAM initialization sequence
- DSM: Deep sleep mode, for low-power SDRAM

5.2.2.2 Generic SDRAM Initialization Example

On power-on reset, software must initialize the MPMC and each of the dynamic memories connected to the controller. Check the dynamic memory data sheet for the start up procedure. A generic example initialization sequence is shown below:

- Wait 100 ms after the power is applied and the clocks have stabilized.
- Set the SDRAM Initialization (I) value to NOP in the **MPMC Dynamic Control** register. This automatically issues a NOP command to the SDRAM memories.
- Wait 200 ms.
- Set the SDRAM Initialization (I) value to PALL in the **MPMC Dynamic Control** register. This automatically issues a pre-charge all instruction (PRE-ALL) to the SDRAM memories. This pre-charges all banks and places the device into the all banks idle state.
- Perform a number of refresh cycles, by writing 1 into the refresh register, **MPMC Dynamic Refresh**. This provides a memory refresh every 16 AHB clock cycles.
- Wait until eight SDRAM refresh cycles have occurred (128 AHB clock cycles)
- Program the operational value into the refresh register, **MPMC Dynamic Refresh**
- Program the operational value into the latency register, **MPMC Dynamic RAS**
- Program the operational values into the configuration register, **MPMC Dynamic Config 0**. The buffers must be disabled during initialization.
- Set the SDRAM initialization value (I) to MODE in the **MPMC Dynamic Control** register.
- Program the SDRAM memories mode register. The mode register enables the following parameters to be programmed.
 - Burst length
 - Burst type
 - CAS latency
 - Operating mode
 - Write burst mode
- Set the SDRAM initialization value (I) to NORMAL in the **MPMC Dynamic Control** register.
- Enable the buffers in the **MPMC Dynamic Config 0** configuration register. The SDRAM is now ready for normal operation.

5.3 MPMC Registers Description

The below describes the MPMC registers in great detail.

Note: For ALL Reserved Registers please note: Read is defined and all must be written as zeros.

5.3.1 MPMC Registers

Table 27 Registers Address Space

Module	Base Address	End Address	Note
MPMC	1100 0000 _H	1100 0278 _H	

Table 28 Registers Overview

Register Short Name	Register Long Name	Offset Address	Page Number
MPMC_C	MPMC Control	000 _H	57
MPMC_S	MPMC Status	004 _H	57
MPMC_Conf	MPMC Configuration	008 _H	59
MPMC_DC	MPMC Dynamic Control	020 _H	60
MPMC_DR	MPMC Dynamic Refresh	024 _H	61
MPMC_DRP	MPMC Dynamic RP	030 _H	62
MPMC_DRAS	MPMC Dynamic RAS	034 _H	62
MPMC_DSREX	MPMC Dynamic SREX	038 _H	62
MPMC_DAPR	MPMC Dynamic APR	03C _H	64
MPMC_DDAL	MPMC Dynamic DAL	040 _H	64
MPMC_DWR	MPMC Dynamic WR	044 _H	64
MPMC_DRC	MPMC Dynamic RC	048 _H	66
MPMC_DRFC	MPMC Dynamic RFC	04C _H	66
MPMC_DXSR	MPMC Dynamic XSR	050 _H	66
MPMC_DRRD	MPMC Dynamic RRD	054 _H	68
MPMC_DMRD	MPMC Dynamic MRD	058 _H	68
MPMC_SEW	MPMC Static Extended Wait	080 _H	68
MPMC_DC0	MPMC Dynamic Config 0	100 _H	70
MPMC_DRC0	MPMC Dynamic Ras Cas 0	104 _H	74
MPMC_DC1	MPMC Dynamic Config 1	120 _H	73
MPMC_DRC1	MPMC Dynamic Ras Cas 1	124 _H	75
MPMC_SC1	MPMC Static Config 1	220 _H	76
MPMC_SWW1	MPMC Static Wait Wen 1	224 _H	82
MPMC_SWO1	MPMC Static Wait Oen 1	228 _H	85
MPMC_SWR1	MPMC Static Wait Rd 1	22C _H	88
MPMC_SWP1	MPMC Static Wait Page 1	230 _H	91
MPMC_SWWR1	MPMC Static Wait Wr 1	234 _H	94
MPMC_SWT1	MPMC Static Wait Turn 1	238 _H	97
MPMC_SC2	MPMC Static Config 2	240 _H	78
MPMC_SWW2	MPMC Static Wait Wen 2	244 _H	83

Table 28 Registers Overview (cont'd)

Register Short Name	Register Long Name	Offset Address	Page Number
MPMC_SWO2	MPMC Static Wait Oen 2	248 _H	86
MPMC_SWR2	MPMC Static Wait Rd 2	24C _H	89
MPMC_SWP2	MPMC Static Wait Page 2	250 _H	92
MPMC_SWWR2	MPMC Static Wait Wr 2	254 _H	95
MPMC_SWT2	MPMC Static Wait Turn 2	258 _H	98
MPMC_SC3	MPMC Static Config 3	260 _H	80
MPMC_SWW3	MPMC Static Wait Wen 3	264 _H	84
MPMC_SWO3	MPMC Static Wait Oen 3	268 _H	87
MPMC_SWR3	MPMC Static Wait Rd 3	26C _H	90
MPMC_SWP3	MPMC Static Wait Page 3	270 _H	93
MPMC_SWWR3	MPMC Static Wait Wr 3	274 _H	96
MPMC_SWT3	MPMC Static Wait Turn 3	278 _H	99

The register is addressed wordwise.

Table 29 Registers Access Types

Mode	Symbol	Description Hardware (HW)	Description Software (SW)
Basic Access Types			
read/write	rw	Register is used as input for the HW	Register is read and writable by SW
read/write virtual	rvv	Physically, there is no new register in the generated register file. The real readable and writable register resides in the attached hardware.	Register is read and writable by SW (same as rw type register)
read	r	Register is written by HW (register between input and output -> one cycle delay)	Value written by SW is ignored by HW; that is, SW may write any value to this field without affecting HW behavior
read only	ro	Same as r type register	Same as r type register
read virtual	rv	Physically, there is no new register in the generated register file. The real readable register resides in the attached hardware.	Value written by SW is ignored by HW; that is, SW may write any value to this field without affecting HW behavior (same as r type register)
write	w	Register is written by software and affects hardware behavior with every write by software.	Register is writable by SW. When read, the register does not return the value that has been written previously, but some constant value instead.
write virtual	wv	Physically, there is no new register in the generated register file. The real writable register resides in the attached hardware.	Register is writable by SW (same as w type register)
read/write hardware affected	rwh	Register can be modified by hardware and software at the same time. A priority scheme decides, how the value changes with simultaneous writes by hardware and software.	Register can be modified by HW and SW, but the priority SW versus HW has to be specified. SW can read the register.

5.3.1.1 Registers Description

MPMC Control

MPMC_C	Offset	Reset Value
MPMC Control	000_H	1_H

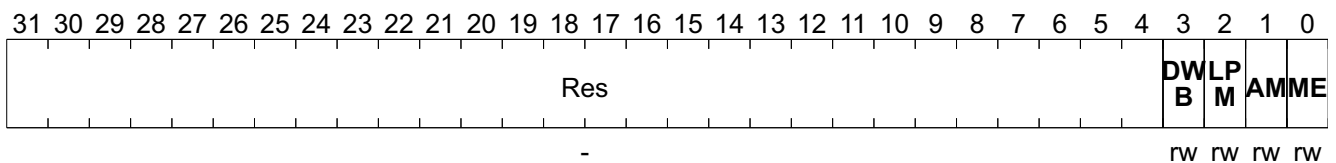

Field	Bits	Type	Description
Res	31:4	-	Not applicable
DWB	3	rw	Drain Write Buffers 0 _B Buffers operate normally (reset value on nPOR, and HRESETn) 1 _B Drain write buffers.
LPM	2	rw	Low-Power Mode Indicate normal, or low-power mode. Entering low-power mode reduces memory controller power consumption. Dynamic memory is refreshed as necessary. The memory controller returns to normal function mode by clearing the low-power mode bit (L), or by system, or power-on reset. 0 _B Normal mode (reset value on nPOR, and HRESETn) 1 _B Low-power mode.
AM	1	rw	Address Mirror Indicates normal or reset memory map. Static memory chip select 1 is mirrored onto chip select 0 and chip select 4 (reset value on nPOR). On power-on reset, chip select 1 is mirrored to both chip select 0 and chip select 1 and chip 4 memory areas. Clearing the M bit enables chip select 0 and chip select 4 memory to be accessed. 0 _B Normal memory map 1 _B Reset memory map.
ME	0	rw	MPMC Enable Indicates if the PrimeCell MPMC is enabled or disabled. Disabling the PrimeCell MPMC reduces power consumption. When the memory controller is disabled the memory is not refreshed. The memory controller is enabled by setting the enable bit, or by system, or power-on reset. 0 _B Disabled 1 _B Enabled (reset value on nPOR, and HRESETn).

MPMC Status

MPMC_S	Offset	Reset Value
MPMC Status	004_H	0_H

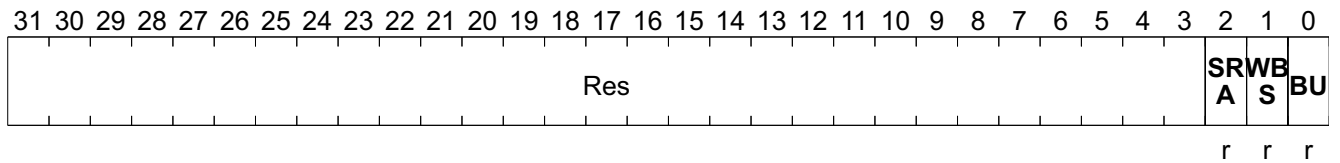

Field	Bits	Type	Description
Res	31:3		Reserved Not applicable
SRA	2	r	Self-Refresh Acknowledge This read only bit indicates the operating mode of the MPMC. 0 _B Normal mode (reset value on nPOR) 1 _B Self-refresh acknowledge.
WBS	1		Write Buffer Status This read only bit enables the PrimeCell MPMC to enter low-power mode or disabled mode cleanly. 0 _B Write buffers empty (reset value on nPOR) 1 _B Write buffers contain data.
BU	0		Busy This read-only bit is used to ensure that the memory controller enters the low-power or disabled mode cleanly. 0 _B MPMC is idle (reset value on nPOR, and HRESETn) 1 _B MPMC is busy performing memory transactions.

MPMC Configuration

MPMC_Conf	Offset	Reset Value
MPMC Configuration	008 _H	0 _H

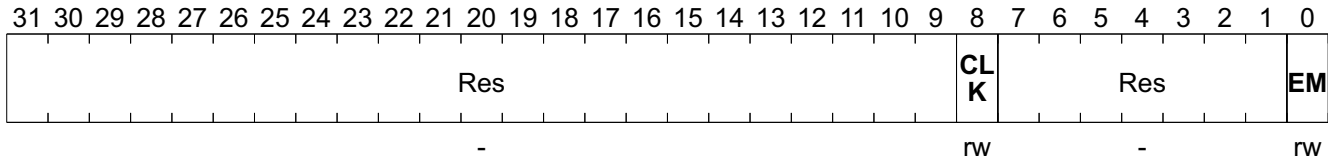

Field	Bits	Type	Description
Res	31:9	-	Reserved Read undefined, must be written as zeros.
CLK	8	rw	Clock Ratio HCLK: MPMCCLKOUT3:0 ratio. 0 _B 1:1 (reset value on nPOR) 1 _B 1:2.
Res	7:1	-	Reserved Read undefined, must be written as zeros.
EM	0	rw	Endian Mode The value of the endian bit on power-on-reset (nPOR) is determined by the MPMCBIGENDIAN signal. This value can be overridden by software. This field is unaffected by the AHB reset (HRESETn). 0 _B Little-endian mode 1 _B Big-endian mode.

MPMC Dynamic Control

MPMC_DC	Offset	Reset Value
MPMC Dynamic Control	020_H	2_H

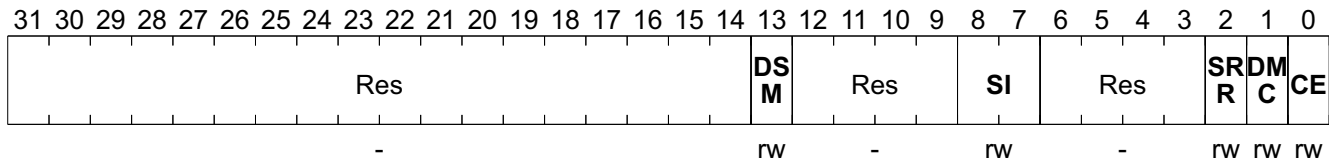

Field	Bits	Type	Description
Res	31:14	-	Reserved Read undefined. Must be written as zeros.
DSM	13	rw	Low-Power SDRAM Deep Sleep Mode 0 _B Normal operation (reset value on nPOR) 1 _B Enter deep power down mode.
Res	12:9	-	Reserved Read undefined. Must be written as zeros.
SI	8:7	rw	SDRAM Initialization 00 _B Issue SDRAM NORMAL operation command (reset value on nPOR) 01 _B Issue SDRAM MODE command 10 _B Issue SDRAM PALL (precharge all) command 11 _B Issue SDRAM NOP (no operation) command.
Res	6:3	-	Reserved Read undefined. Must be written as zeros.
SRR	2	rw	Self-Refresh Request (SR) By writing 1 to this bit self-refresh can be entered under software control. Writing 0 to this bit returns the MPMC to normal mode. The self-refresh acknowledge bit in the MPMCStatus register must be polled to discover the current operating mode of the MPMC. 0 _B Normal mode (reset value on nPOR) 1 _B Enter self-refresh mode.
DMC	1	rw	Dynamic Memory Clock Control When clock control is LOW the output clock MPMCCLKOUT is stopped when there are no SDRAM transactions. The clock is also stopped during self-refresh mode. 0 _B MPMCCLKOUT stops when all SDRAMs are idle and during self-refresh mode 1 _B MPMCCLKOUT runs continuously (reset value on nPOR).
CE	0	rw	Dynamic Memory Clock Enable 0 _B Clock enable of devices are deasserted to save power (reset value on nPOR) 1 _B All clock enables are driven HIGH continuously.

MPMC Dynamic Refresh

MPMC_DR Offset
 MPMC Dynamic Refresh 024_H Reset Value
0_H

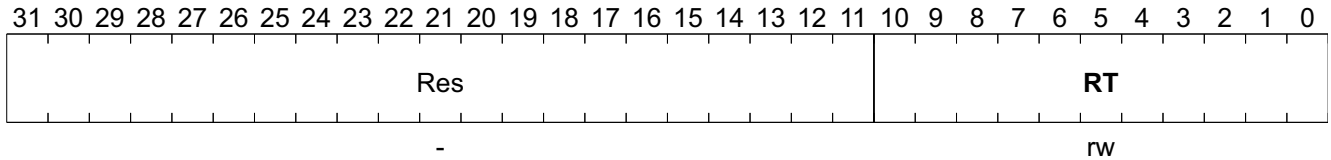

Field	Bits	Type	Description
Res	31:11	-	Reserved Read undefined. Must be written as zeros.
RT	10:0	rw	Refresh Timer 0 _D Refresh disabled (reset value on nPOR) 1 _D 16 HCLK ticks between SDRAM refresh cycles ... _D n _D n x16 HCLK ticks between SDRAM refresh cycles.

CONFIDENTIAL

MultiPort Memory Controller (MPMC)

MPMC Dynamic RP
Note: The delay is in MPMCCLK cycles.

MPMC_DRP	Offset	Reset Value
MPMC Dynamic RP	030_H	F_H

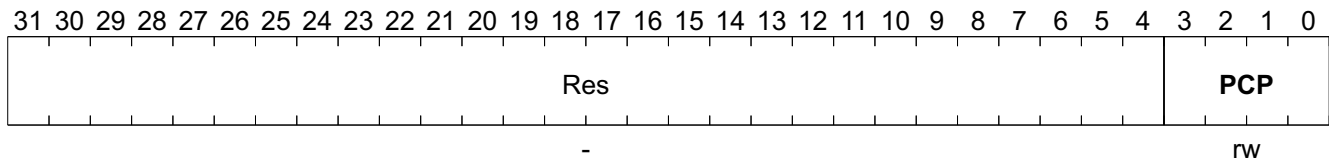

Field	Bits	Type	Description
Res	31:4	-	Reserved Read undefined. Must be written as zeros.
PCP	3:0	rw	Precharge Command Period 0 _H 1 clock cycle ... _H F _H 16 clock cycles (reset value on nPOR)

MPMC Dynamic RAS
Note: The delay is in MPMCCLK cycles.

MPMC_DRAS	Offset	Reset Value
MPMC Dynamic RAS	034_H	F_H

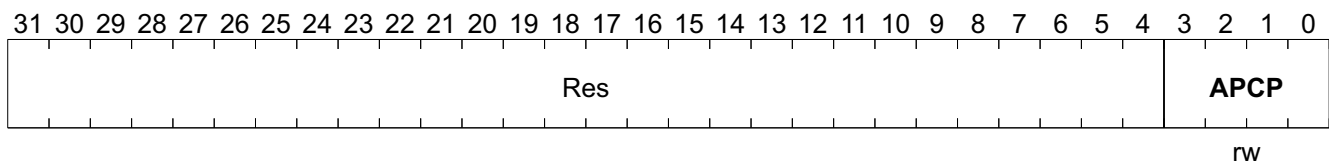

Field	Bits	Type	Description
Res	31:4		Reserved Read undefined. Must be written as zeros.
APCP	3:0	rw	Active to Precharge Command Period 0 _H 1 clock cycle ... _H F _H 16 clock cycles (reset value on nPOR)

MPMC Dynamic SREX
Note: The delay is in MPMCCLK cycles.

MPMC_DSREX	Offset	Reset Value
MPMC Dynamic SREX	038_H	F_H

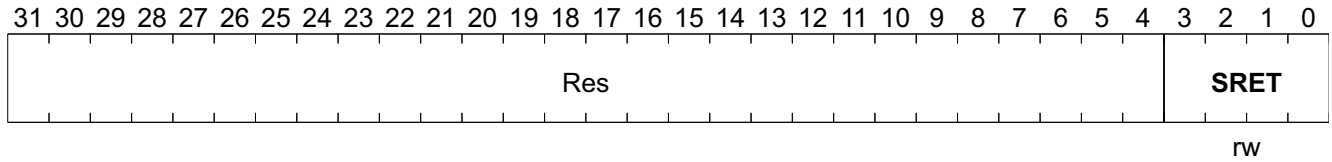

Field	Bits	Type	Description
Res	31:4		Reserved Read undefined. Must be written as zeros.
SRET	3:0	rw	Self-Refresh Exit Time 0 _H 1 clock cycle ... _H F _H 16 clock cycles (reset value on nPOR)

MPMC Dynamic APR

Note: The delay is in MPMCCLK cycles.

MPMC_DAPR	Offset	Reset Value
MPMC Dynamic APR	03C_H	F_H

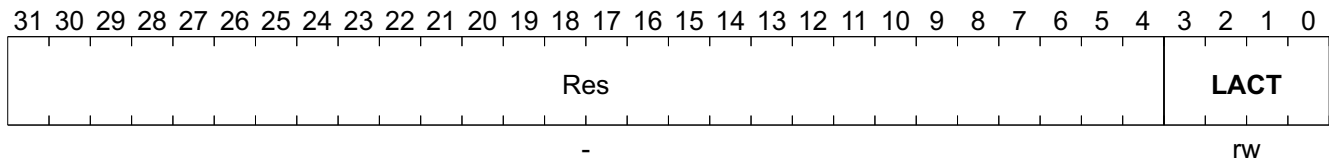

Field	Bits	Type	Description
Res	31:4	-	Reserved Read undefined. Must be written as zeros.
LACT	3:0	rw	Last-Data-Out to Active Command Time 0 _H 1 clock cycle ... _H F _H 16 clock cycles (reset value on nPOR)

MPMC Dynamic DAL

Note: The delay is in MPMCCLK cycles.

MPMC_DDAL	Offset	Reset Value
MPMC Dynamic DAL	040_H	F_H

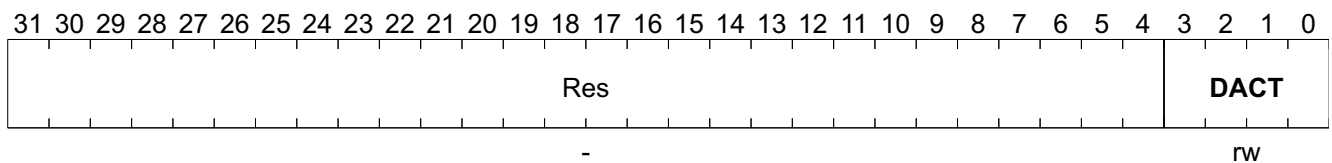

Field	Bits	Type	Description
Res	31:4	-	Reserved Read undefined. Must be written as zeros.
DACT	3:0	rw	Data-In to Active Command Time 0 _H 1 clock cycle ... _H F _H 16 clock cycles (reset value on nPOR)

MPMC Dynamic WR

Note: The delay is in MPMCCLK cycles.

MPMC_DWR Offset Reset Value
 MPMC Dynamic WR 044_H F_H

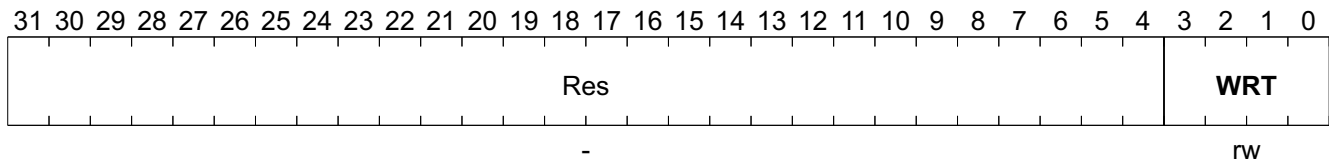

Field	Bits	Type	Description
Res	31:4	-	Reserved
WRT	3:0	rw	Write Recovery Time 0 _H 1 clock cycle ...H F _H 16 clock cycles (reset value on nPOR)

MPMC Dynamic RC

Note: The delay is in MPMCCLK cycles.

MPMC_DRC	Offset	Reset Value
MPMC Dynamic RC	048_H	1F_H

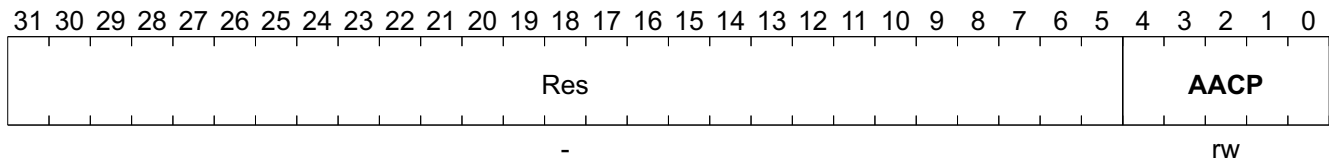

Field	Bits	Type	Description
Res	31:5	-	Reserved
AACP	4:0	rw	Active to Active Command Period 0 _H 1 clock cycle ... _H 1F _H 32 clock cycles (reset value on nPOR)

MPMC Dynamic RFC

Note: The delay is in MPMCCLK cycles.

MPMC_DRFC	Offset	Reset Value
MPMC Dynamic RFC	04C_H	1F_H

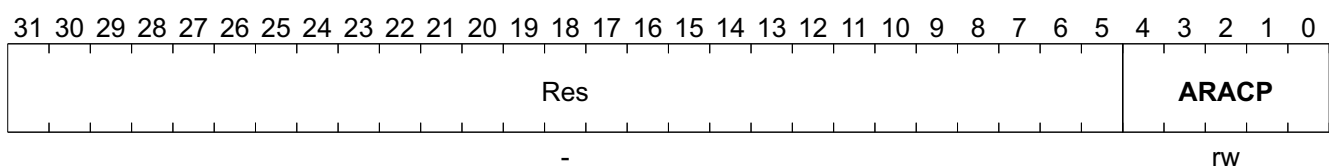

Field	Bits	Type	Description
Res	31:5	-	Reserved
ARACP	4:0	rw	Auto Refresh Period and Auto Refresh to Active Command Period 0 _H 1 clock cycle ... _H 1F _H 32 clock cycles (reset value on nPOR)

MPMC Dynamic XSR

Note: The delay is in MPMCCLK cycles.

MPMC_DXS	Offset	Reset Value
MPMC Dynamic XSR	050_H	1F_H

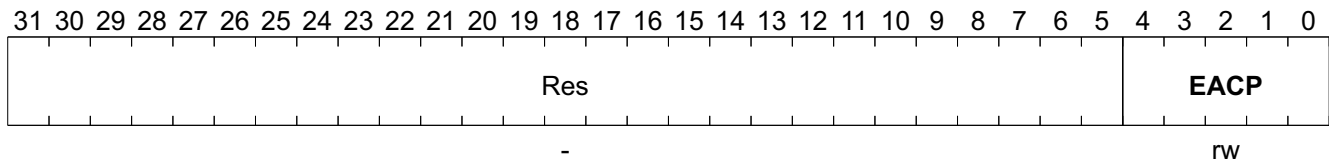

Field	Bits	Type	Description
Res	31:5	-	Reserved
EACP	4:0	rw	Exit Self-Refresh to Active Command Period 0 _H 1 clock cycle ... _H 1F _H 32 clock cycles (reset value on nPOR)

CONFIDENTIAL

MultiPort Memory Controller (MPMC)

MPMC Dynamic RRD

Note: The delay is in MPMCCLK cycles.

MPMC_DRRD	Offset	Reset Value
MPMC Dynamic RRD	054_H	F_H

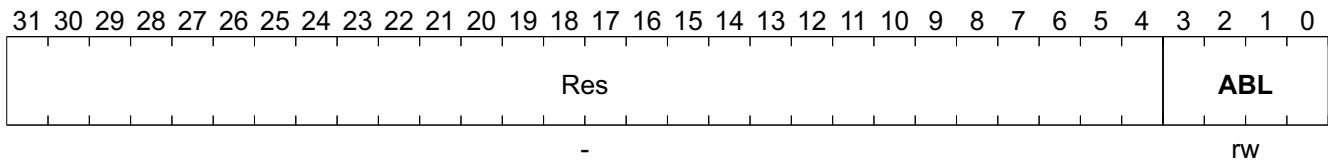

Field	Bits	Type	Description
Res	31:4	-	Reserved
ABL	3:0	rw	Active Bank A to Active Bank B Latency 0 _H 1 clock cycle ... _H F _H 16 clock cycles (reset value on nPOR)

MPMC Dynamic MRD

Note: The delay is in MPMCCLK cycles.

MPMC_DMRD	Offset	Reset Value
MPMC Dynamic MRD	058_H	F_H

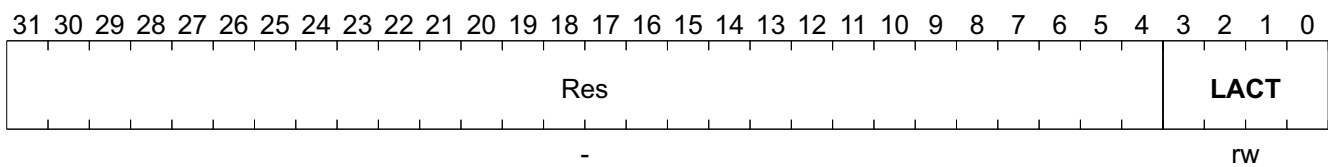

Field	Bits	Type	Description
Res	31:4	-	Reserved
LACT	3:0	rw	Load Mode Register to Active Command Time 0 _H 1 clock cycle ... _H F _H 16 clock cycles (reset value on nPOR)

MPMC Static Extended Wait

Note: The delay is in HCLK cycles.

MPMC_SEW	Offset	Reset Value
MPMC Static Extended Wait	080_H	0_H

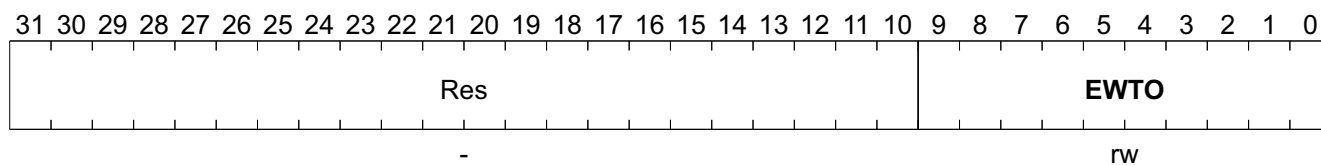

Field	Bits	Type	Description
Res	31:10	-	Reserved
EWTO	9:0	rw	External Wait Time Out 0_D 16 clock cycles (reset value on nPOR) \dots_D n_D $(n+1) \times 16$ clock cycles <i>Note: $n = 0$ to $3FF_H$</i>

MPMC Dynamic Config 0

Note: The offset 100_H and 120_H is for SDRAM bank0 and bank1 respectively.

MPMC_DC0 **Offset** **Reset Value**
MPMC Dynamic Config 0 **100_H** **0_H**

31	30	29	28	27	26	25	24	23	22	21	20	19	18	17	16
Res	RW	Res	NB	Res	CW	Res	WP	BE	Res						
-	rw	-	rw	-	rw	-	rw	rw	-						
15	14	13	12	11	10	9	8	7	6	5	4	3	2	1	0
Res	AM_1	Res			AM_2				Res		MD			Res	
-	rw	-			rw				-		rw			-	

Field	Bits	Type	Description
Res	31:30	-	Reserved
RW	29:28	rw	Row Width 00 _B 11-bit (reset value on nPOR) 01 _B 12-bit 10 _B 13-bit 11 _B Reserved
Res	27	-	Reserved
NB	26	rw	Number of Banks 0 _B Two banks (reset value on nPOR) 1 _B Four banks
Res	25	-	Reserved
CW	24:22	rw	Column Width 000 _B 6-bit (reset value on nPOR) 001 _B 7-bit 010 _B 8-bit 011 _B 9-bit 100 _B 10-bit 101 _B 11-bit 110 _B Reserved 111 _B Reserved
Res	21	-	Reserved
WP	20	rw	Write Protect 0 _B Writes not protected (reset value on nPOR) 1 _B Write protected.
BE	19	rw	Buffer Enable 0 _B Buffer disabled for accesses to this chip select (reset value on nPOR) 1 _B Buffer enabled for accesses to this chip select.

Field	Bits	Type	Description
Res	18:15	-	Reserved
AM_1	14	rw	Address Mapping See Table 30 0 _B Reset value on nPOR
Res	13	-	Reserved
AM_2	12:7	rw	Address Mapping See , Table 30 00000000 _B Reset value on nPOR
Res	6:5	-	Reserved
MD	4:3	rw	Memory Device 00 _B SDRAM(reset value on nPOR) 01 _B Low-power SDRAM 10 _B Reserved 11 _B Reserved
Res	2:0	-	Reserved

Table 30 Address Mapping Table

[14]	[12]	[11:9]	[8:7]	Description
------	------	--------	-------	-------------

16-Bit external bus high performance address mapping (Row, Bank, Column)

0	0	000	00	16MB (2M X 8),2 banks row length=11, column length=9
0	0	000	01	16MB (1M X 16),2 banks, row length=11, column length=8
0	0	001	00	64MB (8M X 8),4 banks, row length=12, column length=9
0	0	001	01	64MB (4M X16),4 banks, row length=12, column length=8
0	0	010	00	128MB (16M X 8),4 banks, row length=12, column length=10
0	0	010	01	128MB (8M X 16), 4 banks, row length=12, column length=9
0	0	011	00	256MB (32M X 8), 4 banks, row length=13, column length=10
0	0	011	01	256MB (16M X 16), 4 banks, row length=13, column length=9
0	0	100	00	512MB (64M X 8), 4 banks, row length=13, column length=11
0	0	100	00	512MB (32M X 16),4 banks, row length=13, column length=10

16-Bit external bus Low-power SDRAM address mapping (Bank, row, Column)

0	1	000	00	16MB (2M X 8),2 banks row length=11, column length=9
0	1	000	01	16MB (1M X 16),2 banks, row length=11, column length=8
0	1	001	00	64MB (8M X 8),4 banks, row length=12, column length=9
0	1	001	01	64MB (4M X16),4 banks, row length=12, column length=8
0	1	010	00	128MB (16M X 8),4 banks, row length=12, column length=10

Table 30 Address Mapping Table

[14]	[12]	[11:9]	[8:7]	Description
0	1	010	01	128MB (8M X 16), 4 banks, row length=12, column length=9
0	1	011	00	256MB (32M X 8), 4 banks, row length=13, column length=10
0	1	011	01	256MB (16M X 16), 4 banks, row length=13, column length=9
0	1	100	00	512MB (64M X 8), 4 banks, row length=13, column length=11
0	1	100	01	512MB (32M X 16), 4 banks, row length=13, column length=10

32-Bit external bus High-Performance address mapping (Row, Bank, Column)

1	0	000	00	16MB (2M X 8), 2 banks, row length=11, column length=9
1	0	000	01	16MB (1M X 16), 2 banks, row length=11, column length=8
1	0	001	00	64MB (8M X 8), 4 banks, row length=12, column length=9
1	0	001	01	64MB (4M X 16), 4 banks, row length=12, column length=8
1	0	001	10	64MB (2M X 32), 4 banks, row length=11, column length=8
1	0	010	00	128MB (16M X 8),4 banks, row length=12, column length=10
1	0	010	01	128MB (8M X 16), 4 banks, row length=12, column length=9
1	0	010	10	128MB (4M X 32), 4 banks, row length=12, column length=8
1	0	011	00	256MB (32M X 8), 4 banks, row length=13, column length=10
1	0	011	01	256MB (16M X 16), 4 banks, row length=13, column length=9
1	0	011	10	256MB (8M X 32), 4 banks, row length=13, column length=8
1	0	100	00	512MB (64M X 8),4 banks, row length=13, column length=11
1	0	100	01	512MB (32M X 16),4 banks, row length=13, column length=10

32-Bit external bus Low-Performance SDRAM mapping (Bank,Row, Column)

1	0	100	01	512MB (32M X 16),4 banks, row length=13, column length=10
1	1	000	00	16MB (2M X 8), 2 banks, row length=11, column length=9
1	1	000	01	16MB (1M X 16), 2 banks, row length=11, column length=8
1	1	001	00	64MB (8M X 8), 4 banks, row length=12, column length=9
1	1	001	01	64MB (4M X 16), 4 banks, row length=12, column length=8
1	1	001	10	64MB (2M X 32), 4 banks, row length=11, column length=8
1	1	010	00	128MB (16M X 8),4 banks, row length=12, column length=10
1	1	010	01	128MB (8M X 16), 4 banks, row length=12, column length=9
1	1	010	10	128MB (4M X 32), 4 banks, row length=12, column length=8
1	1	011	00	256MB (32M X 8), 4 banks, row length=13, column length=10
1	1	011	01	256MB (16M X 16), 4 banks, row length=13, column length=9
1	1	011	10	256MB (8M X 32), 4 banks, row length=13, column length=8
1	1	100	00	512MB (64M X 8),4 banks, row length=13, column length=11
1	1	100	01	512MB (32M X 16),4 banks, row length=13, column length=10

CONFIDENTIAL
MultiPort Memory Controller (MPMC)
MPMC Dynamic Config 1
Note: The offset 100_H and 120_H is for SDRAM bank0 and bank1 respectively.
MPMC_DC1 **Offset** **Reset Value**
MPMC Dynamic Config 1 **120_H** **0_H**

31	30	29	28	27	26	25	24	23	22	21	20	19	18	17	16
Res		RW		Res	NB	Res	CW		Res	WP	BE	Res			
-	rw		-	rw	-	rw		-	rw	rw	-	-			
15	14	13	12	11	10	9	8	7	6	5	4	3	2	1	0
Res	AM_1	Res	AM_2				Res		MD		Res				
-	rw	-	rw				-		rw		-				

Field	Bits	Type	Description
Res	31:30	-	Reserved
RW	29:28	rw	Row Width 00 _B 11-bit (reset value on nPOR) 01 _B 12-bit 10 _B 13-bit 11 _B Reserved
Res	27	-	Reserved
NB	26	rw	Number of Banks 0 _B Two banks (reset value on nPOR) 1 _B Four banks
Res	25	-	Reserved
CW	24:22	rw	Column Width 000 _B 6-bit (reset value on nPOR) 001 _B 7-bit 010 _B 8-bit 011 _B 9-bit 100 _B 10-bit 101 _B 11-bit 110 _B Reserved 111 _B Reserved
Res	21	-	Reserved
WP	20	rw	Write Protect 0 _B Writes not protected (reset value on nPOR) 1 _B Write protected.
BE	19	rw	Buffer Enable 0 _B Buffer disabled for accesses to this chip select (reset value on nPOR) 1 _B Buffer enabled for accesses to this chip select.

Field	Bits	Type	Description
Res	18:15	-	Reserved
AM_1	14	rw	Address Mapping See Table 30 0 _B Reset value on nPOR
Res	13	-	Reserved
AM_2	12:7	rw	Address Mapping See , Table 30 00000000 _B Reset value on nPOR
Res	6:5	-	Reserved
MD	4:3	rw	Memory Device 00 _B SDRAM(reset value on nPOR) 01 _B Low-power SDRAM 10 _B Reserved 11 _B Reserved
Res	2:0	-	Reserved

MPMC Dynamic Ras Cas 0

Notes

1. The RAS to CAS latency (RAS) and CAS latency (CAS) are both defined in MPMCCLK cycles.
2. The offset 104_H and 124_H is for SDRAM bank0 and bank1 respectively.

MPMC_DRC0	Offset	Reset Value
MPMC Dynamic Ras Cas 0	104_H	303_H

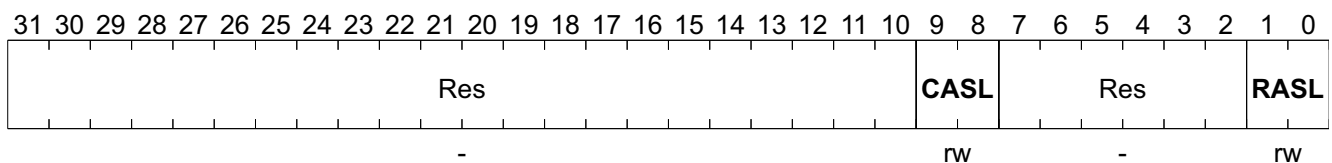

Field	Bits	Type	Description
Res	31:10	-	Reserved
CASL	9:8	rw	CAS Latency 00 _B Reserved 01 _B One clock cycle(a) 10 _B Two clock cycles 11 _B Three clock cycles(reset value on nPOR).
Res	7:2	-	Reserved
RASL	1:0	rw	RAS Latency Active to read or write delay 00 _B Reserved 01 _B One clock cycle(a) 10 _B Two clock cycles 11 _B Three clock cycles (reset value on nPOR).

MPMC Dynamic Ras Cas 1

Notes

1. The RAS to CAS latency (RAS) and CAS latency (CAS) are both defined in MPMCCLK cycles.
2. The offset 104_H and 124_H is for SDRAM bank0 and bank1 respectively.

MPMC_DRC1	Offset	Reset Value
MPMC Dynamic Ras Cas 1	124_H	303_H

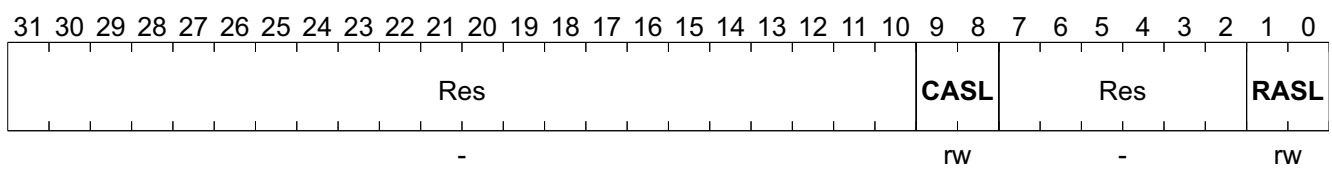

Field	Bits	Type	Description
Res	31:10	-	Reserved
CASL	9:8	rw	CAS Latency 00 _B Reserved 01 _B One clock cycle(a) 10 _B Two clock cycles 11 _B Three clock cycles(reset value on nPOR).
Res	7:2	-	Reserved
RASL	1:0	rw	RAS Latency Active to read or write delay 00 _B Reserved 01 _B One clock cycle(a) 10 _B Two clock cycles 11 _B Three clock cycles (reset value on nPOR).

MPMC Static Config 1

Notes

1. Offset = 220_H is for F_CS0_N respectively.
2. Offset = 240_H, is for External IO CSX0.
3. Offset = 260_H is for External IO CSX1.
4. Synchronous burst mode memory devices are not supported.

MPMC_SC1	Offset	Reset Value
MPMC Static Config 1	220_H	0_H

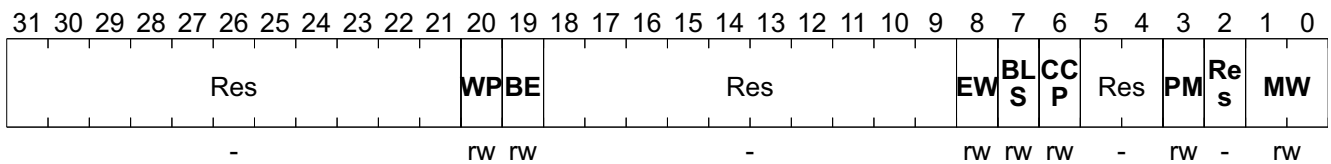

Field	Bits	Type	Description
Res	31:21	-	Reserved
WP	20	rw	Write Protect 0 _B Writes not protected (reset value on nPOR) 1 _B Write protected
BE	19		Buffer Enable 0 _B Write buffer disabled (reset value on nPOR) 1 _B Write buffer enabled
Res	18:9	-	Reserved
EW	8	rw	Extended Wait 0 _B Extended wait disabled (reset value on nPOR) 1 _B Extended wait enabled
BLS	7		Byte Lane State 0 _B For reads all the bits in nMPMCBLSOUT[3:0] are HIGH(reset value on nPOR).For writes the respective active bits innMPMCBLSOUT[3:0] are LOW. 1 _B For reads the respective active bits in nMPMCBLSOUT[3:0] are LOW. For writes the respective active bits in nMPMCBLSOUT[3:0] are LOW.
CCP	6	rw	Chip Select Polarity The values of the chip select polarity on power-on-reset(nPOR) is determined by the relevant MPMCSxPOL signal. This value can be overridden by software. This field is Unaffected by AHB reset (HRESETn). 0 _B Active LOW chip select 1 _B Active HIGH chip select
Res	5:4	-	Reserved

Field	Bits	Type	Description
PM	3	rw	Page Mode 0 _B Disabled (reset value on nPOR) 1 _B Async page mode four enabled.
Res	2	-	Reserved
MW	1:0	rw	Memory Width Define The memory width field define the data width of F_CS0_N. And the default value will be the reset latched value on pins A[18:17]. 00 _B 8 bit 01 _B 16 bit 10 _B 32 bit 11 _B Reserved.

MPMC Static Config 2
Notes

1. Offset = 220_H is for F_CS0_N respectively.
2. Offset = 240_H, is for External IO CSX0.
3. Offset = 260_H is for External IO CSX1.
4. Synchronous burst mode memory devices are not supported.

MPMC_SC2	Offset	Reset Value
MPMC Static Config 2	240_H	0_H

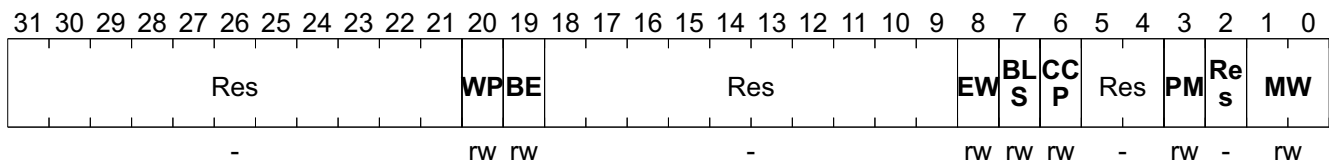

Field	Bits	Type	Description
Res	31:21	-	Reserved
WP	20	rw	Write Protect 0 _B Writes not protected (reset value on nPOR) 1 _B Write protected
BE	19		Buffer Enable 0 _B Write buffer disabled (reset value on nPOR) 1 _B Write buffer enabled
Res	18:9	-	Reserved
EW	8	rw	Extended Wait 0 _B Extended wait disabled (reset value on nPOR) 1 _B Extended wait enabled
BLS	7		Byte Lane State 0 _B For reads all the bits in nMPMCBLSOUT[3:0] are HIGH(reset value on nPOR).For writes the respective active bits innMPMCBLSOUT[3:0] are LOW. 1 _B For reads the respective active bits in nMPMCBLSOUT[3:0] are LOW. For writes the respective active bits in nMPMCBLSOUT[3:0] are LOW.
CCP	6	rw	Chip Select Polarity The values of the chip select polarity on power-on-reset(nPOR) is determined by the relevant MPMCSxPOL signal. This value can be overridden by software. This field is Unaffected by AHB reset (HRESETn). 0 _B Active LOW chip select 1 _B Active HIGH chip select
Res	5:4	-	Reserved

Field	Bits	Type	Description
PM	3	rw	Page Mode 0 _B Disabled (reset value on nPOR) 1 _B Async page mode four enabled.
Res	2	-	Reserved
MW	1:0	rw	Memory Width Define The memory width field defines the data width of External IO CSX0. 00 _B 8 bit 01 _B 16 bit 10 _B 32 bit 11 _B Reserved.

MPMC Static Config 3

Notes

1. Offset = 220_H is for F_CS0_N respectively.
2. Offset = 240_H, is for External IO CSX0.
3. Offset = 260_H is for External IO CSX1.
4. Synchronous burst mode memory devices are not supported.

MPMC_SC3	Offset	Reset Value
MPMC Static Config 3	260_H	0_H

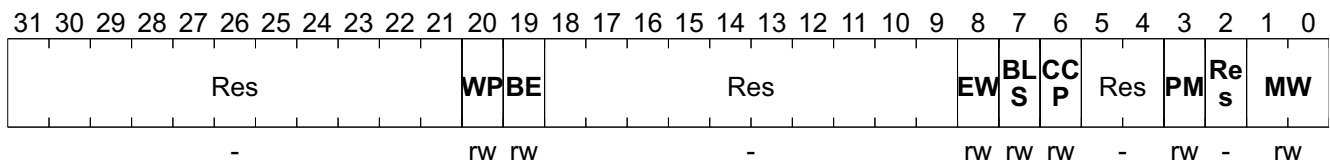

Field	Bits	Type	Description
Res	31:21	-	Reserved
WP	20	rw	Write Protect 0 _B Writes not protected (reset value on nPOR) 1 _B Write protected
BE	19		Buffer Enable 0 _B Write buffer disabled (reset value on nPOR) 1 _B Write buffer enabled
Res	18:9	-	Reserved
EW	8	rw	Extended Wait 0 _B Extended wait disabled (reset value on nPOR) 1 _B Extended wait enabled
BLS	7		Byte Lane State 0 _B For reads all the bits in nMPMCBLSOUT[3:0] are HIGH(reset value on nPOR).For writes the respective active bits innMPMCBLSOUT[3:0] are LOW. 1 _B For reads the respective active bits in nMPMCBLSOUT[3:0] are LOW. For writes the respective active bits in nMPMCBLSOUT[3:0] are LOW.
CCP	6	rw	Chip Select Polarity The values of the chip select polarity on power-on-reset(nPOR) is determined by the relevant MPMCSxPOL signal. This value can be overridden by software. This field is Unaffected by AHB reset (HRESETn). 0 _B Active LOW chip select 1 _B Active HIGH chip select
Res	5:4	-	Reserved

Field	Bits	Type	Description
PM	3	rw	Page Mode 0 _B Disabled (reset value on nPOR) 1 _B Async page mode four enabled.
Res	2	-	Reserved
MW	1:0	rw	Memory Width The memory width field defines the data width of External IO CSX1. 00 _B 8 bit 01 _B 16 bit 10 _B 32 bit 11 _B Reserved.

MPMC Static Wait Wen 1

Notes

1. Offset = 224_H is for F_CS0_N.
2. The delay is (WAITWEN+1) x tHCLK.

MPMC_SWW1	Offset	Reset Value
MPMC Static Wait Wen 1	224_H	0_H

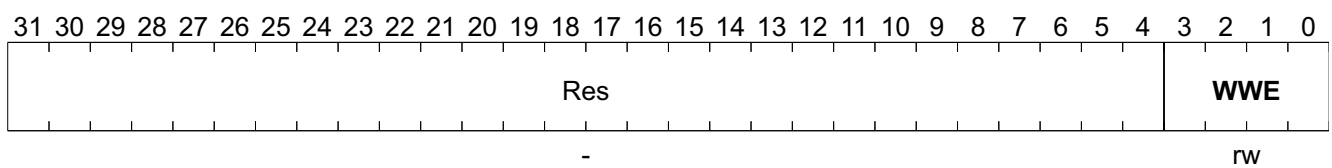

Field	Bits	Type	Description
Res	31:4	-	Reserved
WWE	3:0	rw	Wait Write Enable Delay from chip select assertion to write enable. 0000 _B One HCLK cycle delay between assertion of chip select and write enable (reset value on nPOR) 0001 to 1111 _B =(n+1) HCLK cycle delay.

MPMC Static Wait Wen 2

Notes

1. Offset = 244_H refers to External IO CSX0.
2. The delay is (WAITWEN+1) x tHCLK.

MPMC_SWW2	Offset	Reset Value
MPMC Static Wait Wen 2	244_H	0_H

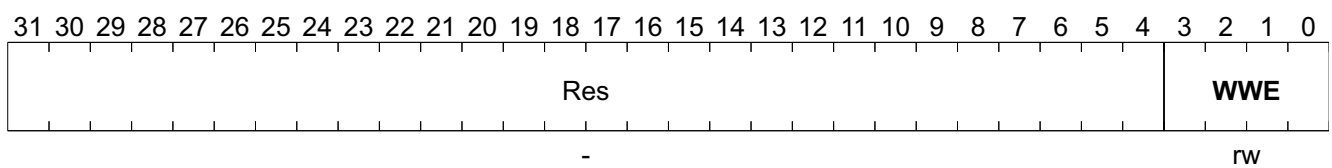

Field	Bits	Type	Description
Res	31:4	-	Reserved
WWE	3:0	rw	Wait Write Enable Delay from chip select assertion to write enable. 0000 _B One HCLK cycle delay between assertion of chip select and write enable (reset value on nPOR) 0001 to 1111 _B =(n+1) HCLK cycle delay.

MPMC Static Wait Wen 3

Notes

1. Offset = 264_H refers to External IO CSX1.
2. The delay is (WAITWEN+1) x tHCLK.

MPMC_SWW3	Offset	Reset Value
MPMC Static Wait Wen 3	264_H	0_H

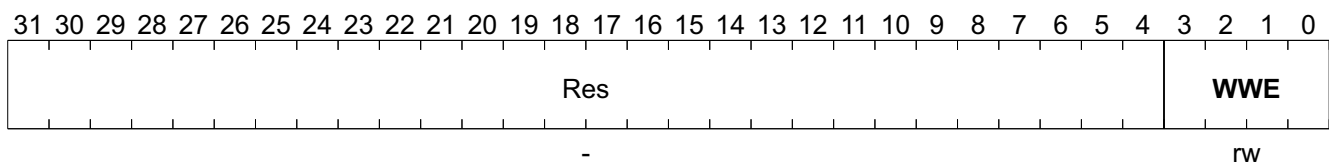

Field	Bits	Type	Description
Res	31:4	-	Reserved
WWE	3:0	rw	Wait Write Enable Delay from chip select assertion to write enable. 0000 _B One HCLK cycle delay between assertion of chip select and write enable (reset value on nPOR) 0001 to 1111 _B =(n+1) HCLK cycle delay.

MPMC Static Wait Oen 1

Notes

1. Offset = 228_H is for F_CS0_N.
2. The delay is WAITOEN x tHCLK.

MPMC_SWO1	Offset	Reset Value
MPMC Static Wait Oen 1	228_H	0_H

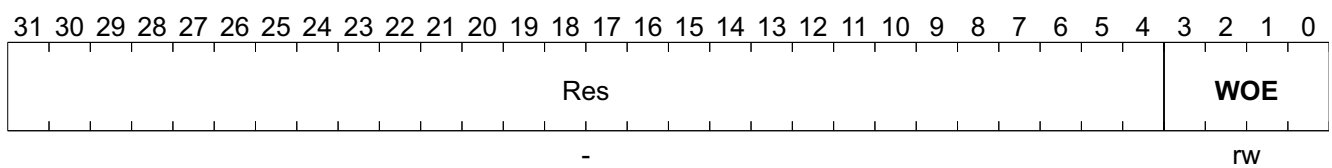

Field	Bits	Type	Description
Res	31:4	-	Reserved
WOE	3:0	rw	Wait Output Enable Delay from chip select assertion to output enable. 0000 _B No delay (reset value on nPOR) 0001 to 1111 _B n cycle delay

MPMC Static Wait Oen 2

Notes

1. Offset = 248_H refers to EXTERNAL IO CSX0.
2. The delay is WAITOEN x tHCLK.

MPMC_SWO2	Offset	Reset Value
MPMC Static Wait Oen 2	248_H	0_H

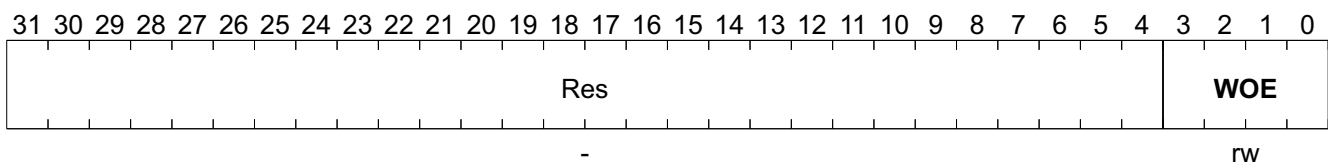

Field	Bits	Type	Description
Res	31:4	-	Reserved
WOE	3:0	rw	Wait Output Enable Delay from chip select assertion to output enable. 0000 _B No delay (reset value on nPOR) 0001 to 1111 _B n cycle delay

MPMC Static Wait Oen 3

Notes

1. Offset = 268_H refers to External IO CSX1.
2. The delay is WAITOEN x tHCLK.

MPMC_SWO3	Offset	Reset Value
MPMC Static Wait Oen 3	268_H	0_H

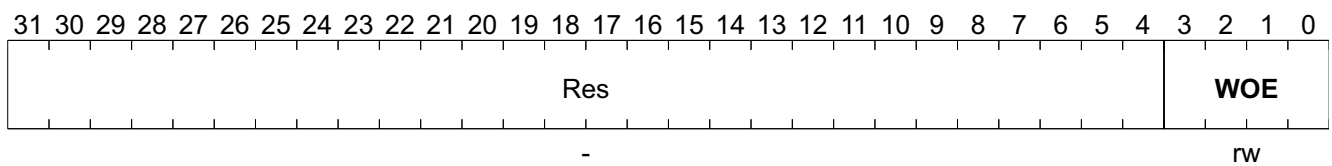

Field	Bits	Type	Description
Res	31:4	-	Reserved
WOE	3:0	rw	Wait Output Enable Delay from chip select assertion to output enable. 0000 _B No delay (reset value on nPOR) 0001 to 1111 _B n cycle delay

MPMC Static Wait Rd 1

Notes

1. Offset = $22C_H$ is for F_CS0_N .
2. For non-sequential reads, the wait state time is $(WAITRD+1) \times tHCLK$.

MPMC_SWR1	Offset	Reset Value
MPMC Static Wait Rd 1	$22C_H$	$1F_H$

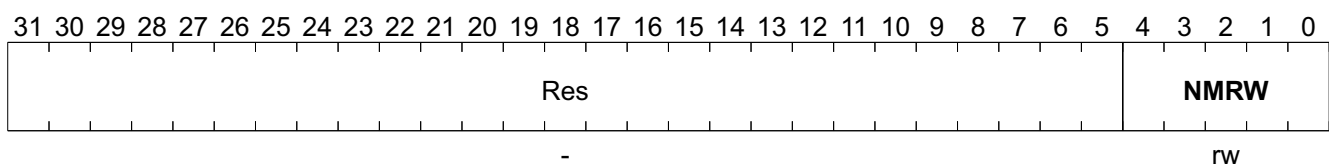

Field	Bits	Type	Description
Res	31:5	-	Reserved
NMRW	4:0	rw	<p>Nonpage Mode Read Wait Nonpage mode read wait states or asynchronous page mode read first access wait state.</p> <p>Nonpage Mode 00000 to 11110_B (n+1) HCLK cycles for read accesses 11111_B 32 HCLK cycles for read accesses(reset value on nPOR).</p> <p>Asynchronous Page Mode Read, First Read Only 00000 to 11110_B (n+1) HCLK cycles for burst read accesses 11111_B 32 HCLK cycles for page read accesses (reset value on nPOR)</p>

MPMC Static Wait Rd 2

Note: Offset = 24C_H refers to External IO CSX0.

MPMC_SWR2	Offset	Reset Value
MPMC Static Wait Rd 2	24C _H	1F _H

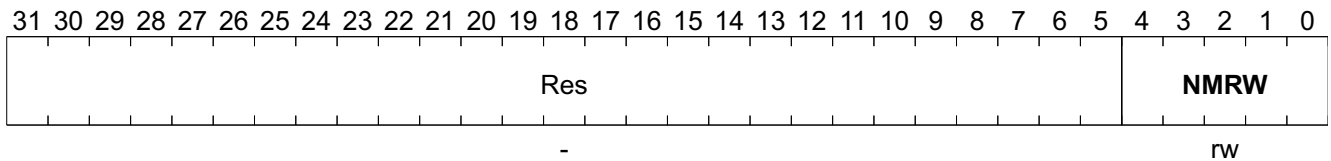

Field	Bits	Type	Description
Res	31:5	-	Reserved
NMRW	4:0	rw	<p>Nonpage Mode Read Wait Nonpage mode read wait states or asynchronous page mode read first access wait state.</p> <p>Nonpage Mode 00000 to 11110_B (n+1) HCLK cycles for read accesses 11111_B 32 HCLK cycles for read accesses(reset value on nPOR).</p> <p>Asynchronous Page Mode Read, First Read Only 00000 to 11110_B (n+1) HCLK cycles for burst read accesses 11111_B 32 HCLK cycles for page read accesses (reset value on nPOR)</p>

MPMC Static Wait Rd 3

Note: Offset = 26C_H refers to External CSX1.

MPMC_SWR3	Offset	Reset Value
MPMC Static Wait Rd 3	26C _H	1F _H

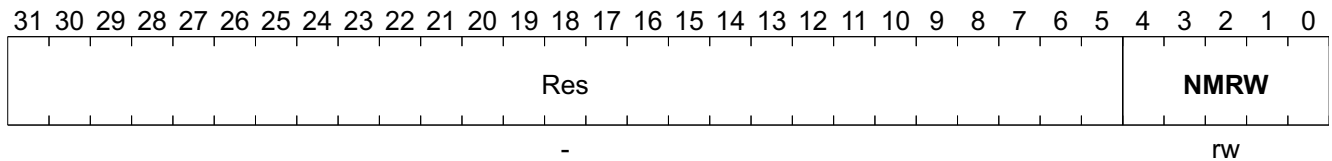

Field	Bits	Type	Description
Res	31:5	-	Reserved
NMRW	4:0	rw	<p>Nonpage Mode Read Wait Nonpage mode read wait states or asynchronous page mode read first access wait state.</p> <p>Nonpage Mode 00000 to 11110_B (n+1) HCLK cycles for read accesses 11111_B 32 HCLK cycles for read accesses(reset value on nPOR).</p> <p>Asynchronous Page Mode Read, First Read Only 00000 to 11110_B (n+1) HCLK cycles for burst read accesses 11111_B 32 HCLK cycles for page read accesses (reset value on nPOR)</p>

MPMC Static Wait Page 1

Notes

1. Offset = 230_H is for F_CS0_N.
2. For asynchronous page mode read for sequential read, the wait state time for page mode accesses after the first read is (WAITPAGE+1) x tHCLK.

MPMC_SWP1	Offset	Reset Value
MPMC Static Wait Page 1	230_H	1F_H

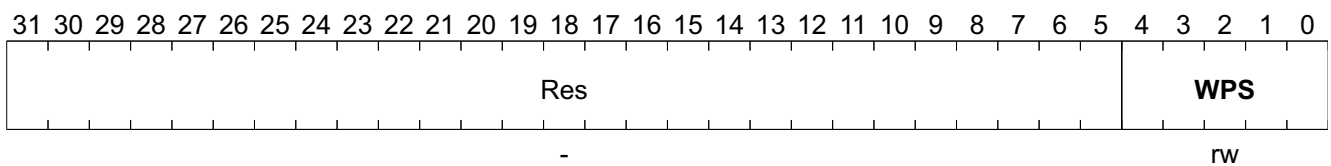

Field	Bits	Type	Description
Res	31:5	-	Reserved
WPS	4:0	rw	Asynchronous Page Mode Read After the First Access Wait States Number of wait states for asynchronous page mode read accesses after the first read. 00000 to 11110 _B (n+1) HCLK cycle read access time 11111 _B 32 HCLK cycle read access time (reset value on nPOR).

MPMC Static Wait Page 2

Note: Offset = 250_H refers to External CSX0.

MPMC_SWP2	Offset	Reset Value
MPMC Static Wait Page 2	250_H	1F_H

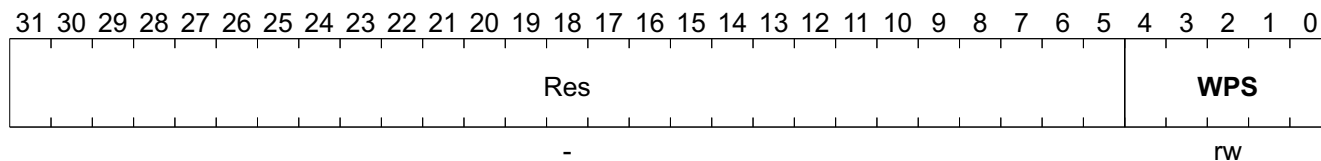

Field	Bits	Type	Description
Res	31:5	-	Reserved
WPS	4:0	rw	Asynchronous Page Mode Read After the First Access Wait States Number of wait states for asynchronous page mode read accesses after the first read. 00000 to 11110 _B (n+1) HCLK cycle read access time 11111 _B 32 HCLK cycle read access time (reset value on nPOR).

MPMC Static Wait Page 3

Note: Offset = 270_H refers to External CSX1.

MPMC_SWP3	Offset	Reset Value
MPMC Static Wait Page 3	270 _H	1F _H

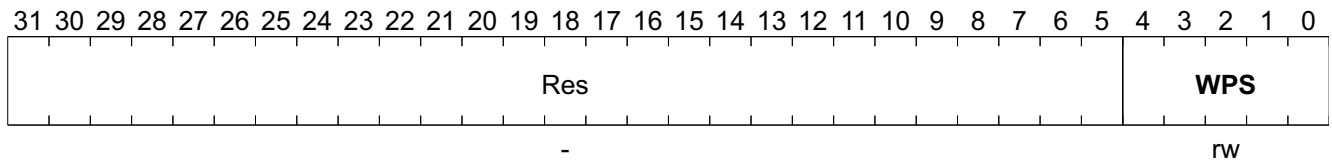

Field	Bits	Type	Description
Res	31:5	-	Reserved
WPS	4:0	rw	Asynchronous Page Mode Read After the First Access Wait States Number of wait states for asynchronous page mode read accesses after the first read. 00000 to 11110 _B (n+1) HCLK cycle read access time 11111 _B 32 HCLK cycle read access time (reset value on nPOR).

MPMC Static Wait Wr 1

Notes

1. Offset = 234_H is for F_CS0_N.
2. The wait state time for write accesses after the first read is WAITWR x tHCLK.

MPMC_SWWR1	Offset	Reset Value
MPMC Static Wait Wr 1	234_H	1F_H

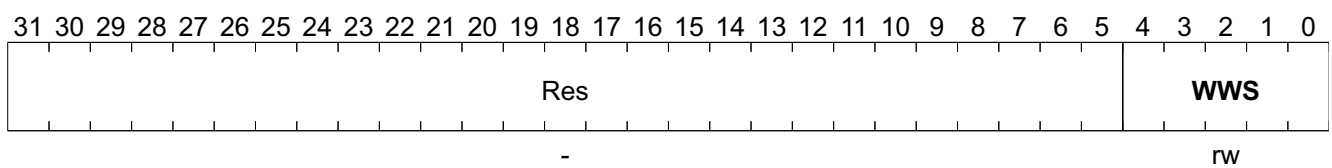

Field	Bits	Type	Description
Res	31:5	-	Reserved
WWS	4:0	rw	Write Wait States SRAM wait state time for write accesses after the first read. 00000 to 11110 _B (n+2) HCLK cycle write access time 11111 _B 33 HCLK cycle write access time (reset value on nPOR).

MPMC Static Wait Wr 2

Note: Offset = 254_H refers to external CSX0.

MPMC_SWWR2	Offset	Reset Value
MPMC Static Wait Wr 2	254 _H	1F _H

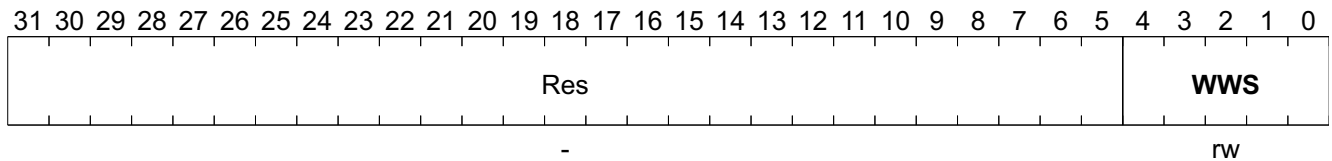

Field	Bits	Type	Description
Res	31:5	-	Reserved
WWS	4:0	rw	Write Wait States SRAM wait state time for write accesses after the first read. 00000 to 11110 _B (n+2) HCLK cycle write access time 11111 _B 33 HCLK cycle write access time (reset value on nPOR).

MPMC Static Wait Wr 3

Note: Offset = 274_H refers to External CSX1.

MPMC_SWWR3	Offset	Reset Value
MPMC Static Wait Wr 3	274 _H	1F _H

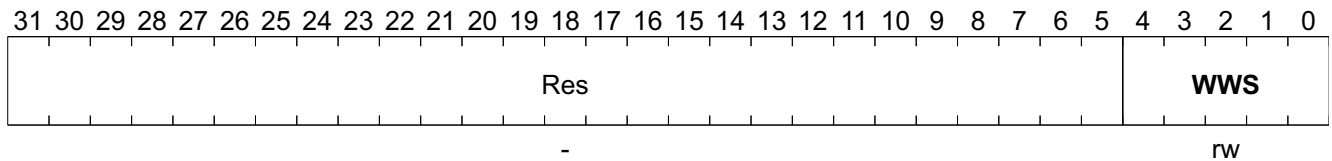

Field	Bits	Type	Description
Res	31:5	-	Reserved
WWS	4:0	rw	Write Wait States SRAM wait state time for write accesses after the first read. 00000 to 11110 _B (n+2) HCLK cycle write access time 11111 _B 33 HCLK cycle write access time (reset value on nPOR).

MPMC Static Wait Turn 1

Notes

1. Offset = 238_H is for F_CS0_N .
2. Bus turnaround time is $(WAITTURN+1) \times tHCLK$.

MPMC_SWT1	Offset	Reset Value
MPMC Static Wait Turn 1	238_H	F_H

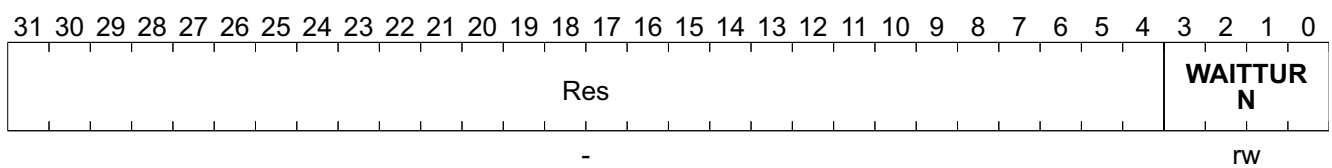

Field	Bits	Type	Description
Res	31:4	-	Reserved
WAITTURN	3:0	rw	Bus Turnaround Cycles 00000 to 1110 _B (n+1) HCLK turnaround cycles 1111 _B 16 HCLK turnaround cycles (reset value on nPOR).

MPMC Static Wait Turn 2

Note: Offset = 258_H refers to External CSX0.

MPMC_SWT2	Offset	Reset Value
MPMC Static Wait Turn 2	258_H	F_H

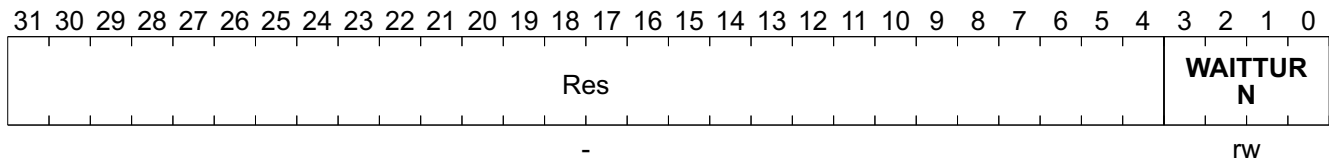

Field	Bits	Type	Description
Res	31:4	-	Reserved
WAITTURN	3:0	rw	Bus Turnaround Cycles 00000 to 1110 _B (n+1) HCLK turnaround cycles 1111 _B 16 HCLK turnaround cycles (reset value on nPOR).

MPMC Static Wait Turn 3

Note: Offset = 278_H refers to External CSX1.

MPMC_SWT3	Offset	Reset Value
MPMC Static Wait Turn 3	278_H	F_H

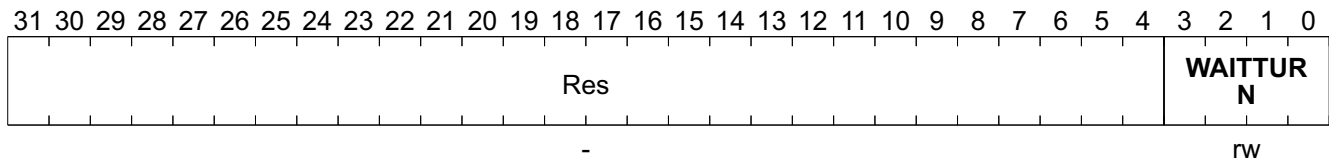

Field	Bits	Type	Description
Res	31:4	-	Reserved
WAITTURN	3:0	rw	Bus Turnaround Cycles 00000 to 1110 _B (n+1) HCLK turnaround cycles 1111 _B 16 HCLK turnaround cycles (reset value on nPOR).

6 Ethernet Switch Controller

The following chapter describes the Ethernet Switch controller functions of the ADM5120P/PX.

6.1 Switch Engine

The switch engine description:

6.1.1 Hashing Function

ADM5120P/PX provides an embedded 1K MAC address look-up table to implement address recognition. The entries of the hashing table are calculated by direct mapping or by an XOR function to produce a 10-bit hashing address entry.

6.1.2 Learning Process

The address learning process is composed of the source address (SA) of packets and the hashing function. ADM5120P/PX will compare the SA of each incoming packet:

- If the source address of an incoming packet is the same as the source MAC address table, then the aging status and port number will be updated.
- If the source address is different from the source MAC address table (mean address collision), then no learning process will occur.

Exceptional cases of address learning:

- The packets have errors
- The port learning has been disabled
- Address collision
- The source address is multicast
- The packets are from the CPU

6.1.3 Routing

When a packet comes from port A, ADM5120P/PX will compare its destination MAC address with the MAC address in the MAC address lookup table. If the address is the same and port is port A this means that the packet is a local packet, it is thus discarded. If the address is the same but port numbers are different, the packet is a unicast packet, and will be forwarded to the assigned port. If the incoming packet is a broadcasted one, a multicast one, or an unknown one (i.e. the destination address cannot be found in the MAC address lookup table), then the routing scheme will broadcast it to all ports.

If the MAC address is a VLAN address, then the packet will be routed to the CPU port. The VLAN address is programmed by the CPU, but not from address learning.

6.1.4 Forwarding

ADM5120P/PX provides a store-and-forward method as a forwarding scheme. Each outgoing packet, including "to-CPU" packets, will be stored, first in the buffer, and then directly sent to the assigned port or CPU via the DMA. However, only the good and non-local packets will be sent.

6.1.5 Buffer Management

The buffer memory is embedded in ADM5120P/PX for the switch operations, which are designed based on output queuing and dynamic shared memory management architecture. It will assign buffer resources based on the traffic status. In addition, this efficiency method can avoid the problem of Head-on-Line (HOL) blocking and cause better transmitting performance.

6.1.6 Flow Control

The on/off status for flow control depends on the global empty buffer count and per-port waiting-transmit count. Based on this intelligent scheme, if the packet transmits to a destination port that is full, then the flow control is turned on. In this situation, the full condition is released, including packets transmitted out or disabled. The flow control is then turned off.

ADM5120P/PX does not allow flow control to the CPU, i.e.. it never sends the flow control packets to the CPU port, so the firmware needs to monitor the buffer status to prevent packet loss.

6.1.7 Full Duplex

In full duplex flow control, ADM5120P/PX follows IEEE 802.3x standards. If a PAUSE frame is received from a certain port, it will stop the port transmission of packets until the timer times out or another PAUSE frame with zero time is received. If the buffer is full and is in full-duplex mode, ADM5120P/PX will send a PAUSE frame with the maximum value, to defer the receiving packet. When enough buffer space is released, the PAUSE frame with zero delay is sent.

- Pause Frame must meet all of the following specs:
 - Right DA: DA=0180c2000001 or unicast MAC address belongs to the CPU
 - Right type field = 8808
 - Right op-code = 0001
 - Right CRC

6.1.8 Half Duplex

In half-duplex operation, ADM5120P/PX supports a back pressure feature. If free blocks in the buffer memory are below the threshold, a jam packet (jam mode) is sent to the connected segment, regardless of routing decisions.

6.1.9 Packet Priority and Class of Service (CoS)

ADM5120P/PX can set the packets as high priority via registers as follows:

- Port based priority, refer to register [Priority Control](#) bits [5:0]
- VLAN tag, refer to registers [VLAN Priority](#)
- TCP/IP TOS/DS, refer to registers [TOS Enable](#), [TOS Map 0](#) and [TOS Map 1](#)
- Customer defined type, refer to registers [Custom Priority 1](#) and [Custom Priority 2](#)

The priority setting by port means that all the packets received by the port will be priority frames. ADM5120P/PX can also judge the priority of frames by checking the specific bits of VLAN tag or TCP/IP TOS/DS in the frame or the customer defined type.

It will determine the packet priority. First it will check if the packet type meets VLAN or TCP/IP. Then, it will check whether the value of the VLAN tag or the TCP/IP TOS/DS field meets the registers setting. Depending on these two conditions, the scheme of weighted round robin can determine the high and low priority of frames, and thus set the transmitting order.

ADM5120P/PX provides a function to improve the delay-time sensitive traffic in the flow-control condition. When the port receives a priority frame, the back pressure & 802.3x flow control can be turned off until no priority frame occurs within 1 or 2 seconds, then turned back on again. So it can prevent the jitter caused by the flow control and give a better timing-variation result for the priority traffic. This is a register programmable function.

All the packets from the CPU port will be treated as high priority for the switch ports and the best effort result for the CPU traffic will be provided.

6.1.10 VLAN

ADM5120P/PX supports a seven port-grouping VLAN. Each of the VLAN will be treated as isolated ports. For the VLAN grouping setting, refer to the registers [VLAN Group I](#) and [VLAN Group II](#).

ADM5120P/PX provides the VLAN MAC address function, if the packet is assigned with the VLAN address as its destination MAC address, then this packet will be forwarded to the CPU via DMA.

For example, port0 is the WAN port. The others are the LAN ports, then the WAN ports are set as VLAN1 and the others set as VLAN2. The different MAC addresses for the VLAN1/2 are programmed into the address table. Then if the LAN ports receive packets with VLAN2 addresses, the packets will be forward to the CPU via DMA. After processing the packets (like NAT), the CPU can forward the packets to VLAN1.

6.1.11 Address Table Access

ADM5120P/PX provides the access for the embedded MAC address.

- Read - refer to the registers **Search CMD**, **Address ST0** and **Address St1** Issue the search-start command. ADM5120P/PX will automatically search the embedded address table and report the valid one only. If at the end of a table, it will also report the status.
- Write - refer to registers **MAC Write Address 0** and **MAC Write Address 1** Fill in the write address and other information, like port number (or VLAN number), age-time (or static), then issue the write command and wait for the write done bit.

6.1.12 Address Security

The ADM5120P/PX supports the source MAC address security function, register **Port Conf1**(B+2C) bits [31:26]. It can check all-incoming packets in the enable ports – find if the source MAC exists in the MAC address table or not, if not, discard the packets and report the status, register **Port St**(B+18) bits [5:0].

6.1.13 Bandwidth Control Function

ADM5120P/PX can provide the RX/TX separated bandwidth control (or traffic shaping) function, which can be programmed to 64 kbit / 128 kbit / 256 kbit / 512 kbit / 1 Mbit / 4 Mbit / 10 Mbit. Refer the registers **Bandwidth Control 0** and **Bandwidth Control 1**.

In a fixed period, ADM5120P/PX will count the per port RX and TX byte number, and compare with the bandwidth control threshold. If it is over this threshold, ADM5120P/PX will turn on the proprietary scheme to control the RX/TX behavior.

6.1.14 MII Port

The MII port can be programmed for the following: AN monitor on/off, force speed/duplex/flow-control, which can be set by Switch Control Register **Port Conf2**(B+30).The MII direction is also programmable for the following: connect to PHY or MAC, which can be set by Switch Control Register **Port Conf2**(B+30).The default MII mode is normal mode that is 'connect to PHY'. When it is configured to Reverse MII mode. The ADM5120P/PX will output TXC, RXC, CRS and COL. The signals direction will change, and suggest the connection as below:

Table 31 Connection between ADM5120P/PX and MAC Controller

5120P Signal	MAC Signal
RXC	RXC
TXE	RXDV
TXD	RXD
RXDV	TXEN
RXD	TXD
COL	COL
CRS	CRS

6.2 DMA Function Description

The DMA function provides the packets with transmit and receive to/from CPU. There are two priority queues in each path -- transmit and receive. The start address is defined by the base address registers. You can refer to registers in [Send High Base Address](#), [Send Low Base Address](#), [Receive High Base Address](#) and [Receive Low Base Address](#) for details. Every queue is a ring architecture. See the tables for details.

When the packet is put on the data buffer and send descriptor is prepared, software can trigger the DMA to move the data to the internal buffer by setting the [Send Trigger](#) register.

6.2.1 Send Descriptors Content

If CPU sends the packet to a switch, either LAN or WAN, then the 'send descriptors' are used as follows:

Bit	Bit[31]	Bit[28]	Bit[24:0]	Remark
Type		Control		Controlled by CPU except Own-bit
Function	Own bit	Ring end flag	buffer1_address[24:0]	

Bit	Bit[31]	Bit[24:0]	Remark
Type	Control		Controlled by CPU
Function	buffer2_enable	buffer2_address[24:0]	

Bit	Bit[10:0]	Remark
Type	Control	Controlled by CPU
Function	buffer1_length[10:0]	

Bit	Bit[31]	Bit[26:16]	Bit[13:8]	Bit[5:0]	Remark
Type	Control				Controlled by CPU
Function	append_chksum	pkt-length[10:0]	force desti-port[5:0]	To_VLAN[5:0]	

6.2.1.1 Control

- Own Bit:
 - If 0, the descriptor belongs to CPU. After the data is put in the buffer and control bits are set, this bit will change to 1 to indicate that SW can process this packet.
 - If 1, the descriptor is for SW, and after the data is taken away, then it is loaded to SW data buffer, the bit will be then set to 0.
- Ring end:
 - If 1, the descriptor is the last one, the next descriptor needs to return to the base address.
- Buffer information:
 - Each descriptor can support two buffers.
 - The buffer address can be any byte alignment.
 - Buffer1 has length information, if packet size is larger than buffer1 size, then get the rest of the data from buffer2.
 - Buffer address must be valid when a descriptor belongs to a switch, the switch engine will not check the address status.
 - Buffer2 has an enable bit to control whether the address is valid or not.
 - If the buffer2 is disabled and buffer1 is not long enough, then the remaining data will not be padded 0 to make the packet meet 64-bytes standard.
- Append_chksum: need to append the IP (0800_H) and PPPoE (8864_H) packets IP-checksum by hardware
 - The packet checksum field must be pre-filled with all 0's
- Packet length: the packet length in bytes, excluding CRC if CRC is not padded. (See the register, CPU_{up}_conf)
 - Auto-padding: the engine can automatically pad the 0 into the packet which data size is less than 60 B (or 64). The setting example: buffer 1 size=14, buffer 2 disable, the pkt length=60 (or 64 without CRC padding).

- Force desti-port[5:0]: the packet needs force forwarding to designated ports, and it is the highest priority of routing. If forced, then ignore the routing and To_VLAN flag.
- To_VLAN[5:0]: the bit-map, the packet forwards to the designated VLAN group. Use this flag to control the packets to LAN, WAN, or HPNA ports.

6.2.2 Receive Descriptors Content

If switch sends the packet to CPU, either LAN or WAN, then the 'receive descriptors' are used as follows:

Bit	Bit[31]	Bit[28]	Bit[24:0]	Remark
Type		Control		Controlled by CPU except Own-bit
Function	Own bit	Ring end flag	buffer1_address[24:0]	

Bit	Bit[31]	Bit[24:0]	Remark
Type	Control		Controlled by CPU
Function	buffer2_enable	buffer2_address[24:0]	

Bit	Bit[10:0]	Remark
Type	Control	Controlled by CPU
Function	buffer1_length[10:0]	

Bit	[26:16]	[14:12]	[5:4]	[3]	[2]	[1:0]	Remark
Type	Packet status						Updated by switch
Function	pkt-length[10:0]	Source port number		00: UC01: MC10: BC	IP checksum fail	VLAN tag	00: 0800H01: 8864H11, 10: reserved

6.2.2.1 Control

- Own bit:
 - If 0, the descriptor belongs to CPU.
 - If 1, the descriptor is released to the WAN MAC or to the LAN SW, which means it can store the incoming packet based on the buffer address. If this is done, change the bit to 0.
- Buffer information:
 - Each descriptor can support two buffers.
 - The buffer address can be any byte alignment.
 - Buffer1 has length information, if packet size is over the buffer1 size, then put the rest of the data into buffer2.
 - Buffer1 address must be valid when descriptor belongs to switch.
 - Buffer2 has a enable bit to control whether the address is valid or not.
 - The buffer2 size must be larger than the remaining data.

- If buffer2 is disabled and buffer1 does not enough space, then the remaining data will be dropped, and no status reported.

6.2.2.2 Status

- Packet length: the packet length in bytes including 4-byte CRC
- Source port: the source port of packet
- DA status:
 - 00: UC, the packet is the forwarded UC packet
 - 01: MC, the packet has 1 in the LSB of first byte of DA
 - 11: BC, the packet has DA=FFFFFFFFFFFF
 - IP checksum fail: if 1 = the IP checksum result is error

Note: Only checked if type = 0800_H (IP) or 8864_H (PPPoE)

- The VLAN tagged frame status (type = 8100_H)
- Packet type:
 - 00: type = 0800_H, IP
 - 01: type = 8864_H, PPPoE
 - 10,11 reserved

6.3 Switch Control Register Map

Although some registers may be marked with a certain type, it may be possible that some bits in this register are different. This is explained in the register description.

Table 32 Registers Address Space

Module	Base Address	End Address	Note
Switch Control	1200 0000 _H	1200 0110 _H	–

Table 33 Registers Overview

Register Short Name	Register Long Name	Offset Address	Page Number
Code	Code	00 _H	110
Sft_Res	Software Reset	04 _H	111
Boot_D	Boot Done	08 _H	112
SW_Res	Software Reset	0C _H	112
GI_St	Global St	10 _H	112
PHY_St	PHY St	14 _H	113
Port_St	Port St	18 _H	114
Mem_Cont	Memory Control	1C _H	116
SW_conf	SW Conf	20 _H	117
CPUp_conf	CPUp Conf	24 _H	119
Port_conf0	Port Conf0	28 _H	120
Port_conf1	Port Conf1	2C _H	121
Port_conf2	Port Conf2	30 _H	122
Res_1	Reserved 1	34 _H	123
Res_2	Reserved 2	38 _H	124
Res_3	Reserved 3	3C _H	124
VLAN_GI	VLAN Group I	40 _H	125
VLAN_GII	VLAN Group II	44 _H	126
Send_trig	Send Trigger	48 _H	126
Srch_cmd	Search CMD	4C _H	126
ADDR_st0	Address ST0	50 _H	128
ADDR_st1	Address St1	54 _H	129
MAC_wt0	MAC Write Address 0	58 _H	129
MAC_wt1	MAC Write Address 1	5C _H	129
BW_cntl0	Bandwidth Control 0	60 _H	130
BW_cntl1	Bandwidth Control 1	64 _H	131
PHY_cntl0	PHY Control 0	68 _H	132
PHY_cntl1	PHY Control 1	6C _H	133
FC_th	Switch Control Threshold	70 _H	133
adj_port_th	Adj Port Threshold	74 _H	133
Port_th	Port Threshold	78 _H	135
PHY_cntl2	PHY Control 2	7C _H	135
PHY_cntl3	PHY Control 3	80 _H	136

Table 33 Registers Overview (cont'd)

Register Short Name	Register Long Name	Offset Address	Page Number
Pri_cntl	Priority Control	84 _H	137
VLAN_pri	VLAN Priority	88 _H	138
TOS_en	TOS Enable	8C _H	139
TOS_map0	TOS Map 0	90 _H	139
TOS_map1	TOS Map 1	94 _H	139
Custom_pri1	Custom Priority 1	98 _H	140
Custom_pri2	Custom Priority 2	9C _H	140
PHY_cntl4	PHY Control 4	A0 _H	142
Empty_cnt	Empty Control	A4 _H	142
Port_cnt_sel	Port Control Select	A8 _H	144
Port_cnt	Port Controller	AC _H	145
Int_st	Int St	B0 _H	146
Int_mask	Interrupt Mask	B4 _H	147
GPIO_conf0	GPIO Conf 0	B8 _H	149
GPIO_conf2	GPIO Conf 2	BC _H	149
Wdog_0	Watchdog 0	C0 _H	151
Wdog_1	Watchdog 1	C4 _H	152
Swap_in	Swap In	C8 _H	153
Swap_out	Swap Out	CC _H	153
send_Hbaddr	Send High Base Address	D0 _H	153
send_Lbaddr	Send Low Base Address	D4 _H	154
rec_Hbaddr	Receive High Base Address	D8 _H	155
rec_Lbaddr	Receive Low Base Address	DC _H	155
send_Hwaddr	Send High Working Address	E0 _H	156
send_Lwaddr	Send Low Working Address	E4 _H	156
rec_Hwaddr	Receive High Working Address	E8 _H	157
rec_Lwaddr	Receive Low Working Address	EC _H	157
Timer_int	Timer Interrupt	F0 _H	158
Timer	Timer	F4 _H	159
Res_4	Reserved 4	F8 _H	160
Res_5	Reserved 5	FC _H	161
port0_LED	Port 0 LED	100 _H	161
port1_LED	Port 1 LED	104 _H	162
port2_LED	Port 2 LED	108 _H	164
port3_LED	Port 3 LED	10C _H	165
port4_LED	Port 4 LED	110 _H	166

The register is addressed wordwise.

Table 34 Registers Access Types

Mode	Symbol	Description Hardware (HW)	Description Software (SW)
Basic Access Types			
read/write	rw	Register is used as input for the HW	Register is read and writable by SW
read/write virtual	rvv	Physically, there is no new register in the generated register file. The real readable and writable register resides in the attached hardware.	Register is read and writable by SW (same as rw type register)
read	r	Register is written by HW (register between input and output -> one cycle delay)	Value written by SW is ignored by HW; that is, SW may write any value to this field without affecting HW behavior
read only	ro	Same as r type register	Same as r type register
read virtual	rv	Physically, there is no new register in the generated register file. The real readable register resides in the attached hardware.	Value written by SW is ignored by HW; that is, SW may write any value to this field without affecting HW behavior (same as r type register)
write	w	Register is written by software and affects hardware behavior with every write by software.	Register is writable by SW. When read, the register does not return the value that has been written previously, but some constant value instead.
write virtual	wv	Physically, there is no new register in the generated register file. The real writable register resides in the attached hardware.	Register is writable by SW (same as w type register)
read/write hardware affected	rwh	Register can be modified by hardware and software at the same time. A priority scheme decides, how the value changes with simultaneous writes by hardware and software.	Register can be modified by HW and SW, but the priority SW versus HW has to be specified. SW can read the register.

Table 35 Registers Clock Domains

Clock Short Name	Description
-	-

6.3.1 Registers Description

Code

Code	Offset	Reset Value
Code	00_H	12085120_H

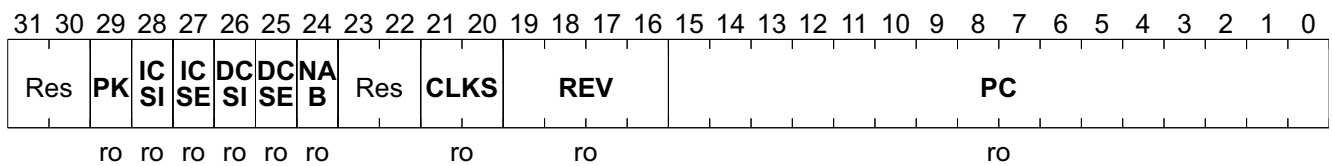

Field	Bits	Type	Description
Res	31:30		Reserved Not Applicable.
PK	29	ro	Package type 0 _B BGA 1 _B 208 PQFP
ICSI	28	ro	Icache Size 0 _B 1 Way 1 _B 2 Ways
ICSE	27	ro	Icache Set 0 _B 4K per way 1 _B 2K per way
DCSI	26	ro	Dcache Size 0 _B 1 Way 1 _B 2 Ways
DCSE	25	ro	Dcache Set 0 _B 4K per way 1 _B 2K per way
NAB	24	ro	NAND Boot Configured in the NAND flash boot.
Res	23:22		Reserved
CLKS	21:20	ro	Clock SPD The PLL setting. 00 _B 175 MHz (Default) 01 _B Reserved 1x _B Reserved
REV	19:16	ro	Revision Revision code = 1000
PC	15:0	ro	Product Code Product code = 5120H

Software Reset

Note: Whenever you write the register offset 04_H, the SftReset will be active.

Sft_Res	Offset	Reset Value
Software Reset	04 _H	1 _H

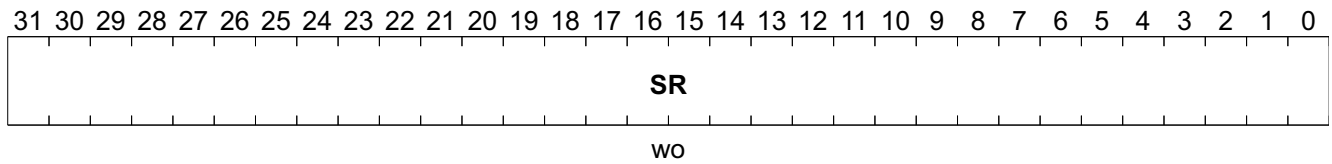

Field	Bits	Type	Description
SR	31:0	wo	Software Reset Do Software reset when write, reset all logic, PHY and memory, and down load the NAND flash content again. Same as hardware reset.

Boot Done

Boot_D **Offset**
Boot Done **08_H** **Reset Value**
0_H

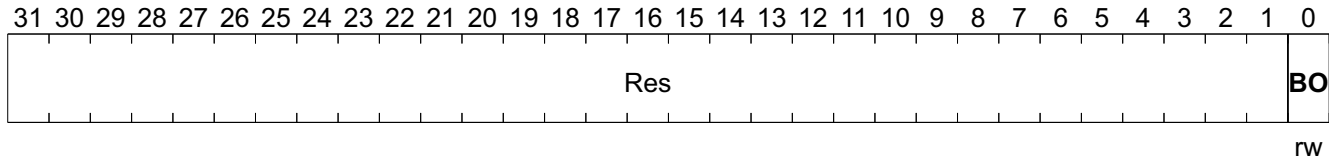

Field	Bits	Type	Description
Res	31:1		Reserved
BO	0	rw	Boot 1 _B The software boot process is done and the address table can return to the switch controller.

Switch Reset

Note: Whenever you write the register offset 0C_H the SWReset will be active.

SW_Res **Offset**
Software Reset **0C_H** **Reset Value**
1_H

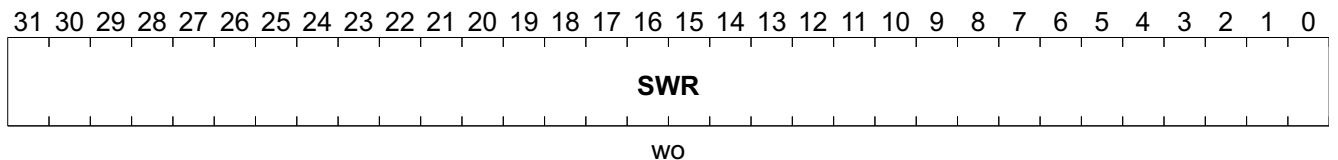

Field	Bits	Type	Description
SWR	31:0	wo	Switch Reset Do Switch reset when write, including Switch engine, data-buffer, link table, and PHY excluding address table. (Recommend stop PHY before reset switch).

Global St

Gl_St **Offset**
Global St **10_H** **Reset Value**
400_H

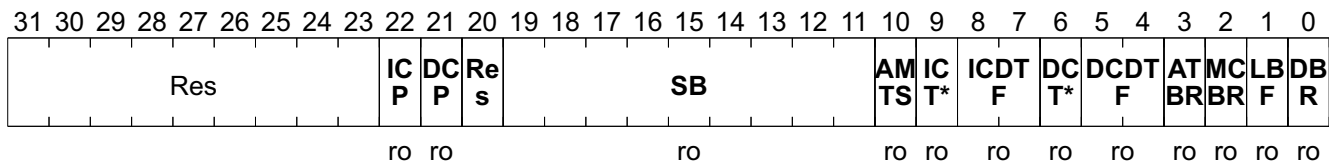

Field	Bits	Type	Description
Res	31:23		Reserved Not Applicable.
ICP	22	ro	Icache Portion For debugging purpose of embedded SRAM.
DCP	21		Dcache Portion For debugging purpose of embedded SRAM.
Res	20		Reserved
SB	19:11	ro	Skip Blocks The number of block is skipped up to 64 blocks.
AMTS	10	ro	All Embedded Memory Test Completed 1 _B Complete
ICTTF	9	ro	Icache Tag Test Fail The memory of I-cache tag. 0 _B Pass
ICDTF	8:7	ro	Icache Data Test Fail Bit 8 and Bit 7 are respectively for the upper and lower 32-bit of I-cache memory for data. 00 _B Pass
DCTTF	6	ro	Dcache Tag Test Fail The memory of D-cache tag. 0 _B Pass
DCDTF	5:4	ro	Dcache Data Test Fail Bit 5 and Bit 4 are respectively for the upper and lower 32-bit of D-cache memory for data. 00 _B Pass
ATBR	3	ro	Address Table BIST Result 0 _B Pass
MCLBR	2	ro	MC Table BIST Result 0 _B Pass
LBF	1	ro	Link Table BIST Result 0 _B Pass
DBR	0	ro	Data Buffer BIST Result 0 _B Pass

PHY St

PHY_St	Offset	Reset Value
PHY St	14_H	0_H

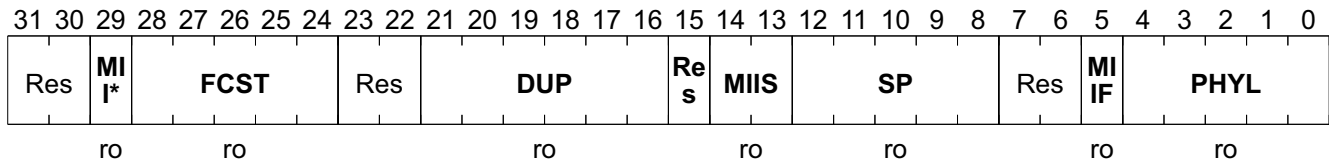

Field	Bits	Type	Description
Res	31:30		Reserved Not Applicable.
MII_FC	29	ro	FC Status of MII Port It is used for flow control status. 0 _B FC off 1 _B FC on
FCST	28:24	ro	FC Bit [28:24] represent PHY port [4:0] flow control status respectively. 1 _B Full duplex and 802.3x flow control ON (after AN or forced).
Res	23:22		Reserved Not Applicable.
DUP	21:16	ro	Duplex 0 _B Half duplex 1 _B Full duplex
Res	15		Reserved Not Applicable.
MIIS	14:13	ro	MII Port Speed 00 _B 10M 01 _B 100M 0x _B Reserved
SP	12:8	ro	Speed 0 _B 10M 1 _B 100M
Res	7:6		Reserved Not Applicable.
MIIF	5	ro	MII Fail 0 _B Port fail 1 _B Link ok
PHYL	4:0	ro	PHY Link Bit[4:0] represent PHY port[4:0] link status respectively 0 _B Down 1 _B Up

Port St

Port_St	Offset	Reset Value
Port St	18 _H	0 _H

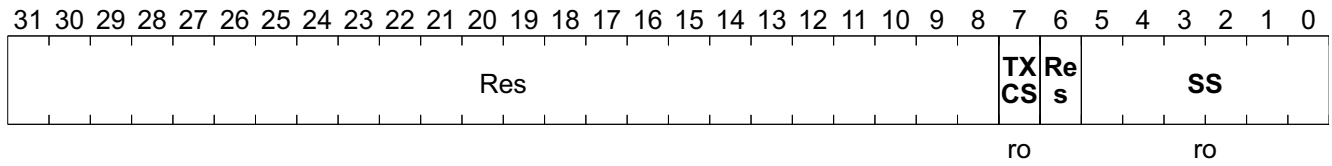

Field	Bits	Type	Description
Res	31:8		Reserved Not Applicable.
TXCS	7	ro	TXC St, MII Port TXC Status 1 _B Error, no TXC or too long period
Res	6		Reserved Not Applicable.
SS	5:0	ro	Security Status 1 _B Has intruder coming if so turn on the SA_secured mode

Memory Control

Mem_Cont	Offset	Reset Value
Memory Control	1C_H	204_H

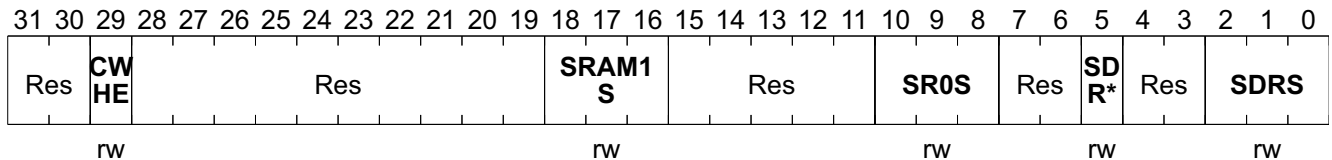

Field	Bits	Type	Description
Res	31:30		Reserved Not Applicable.
CWHE	29	rw	CSX0 Write Hold Extend Extend the write data hold time from one clock to 3 clock (clock period = CLK_OUT). 0 _B Normal, 1 clock, default 1 _B Extend to 3 clocks
Res	28:19		Reserved Not Applicable.
SRAM1S	18:16	rw	SRAM1 Size 000 _B Disable (default) 001 _B 512 Kbyte 010 _B 1 Mbyte 011 _B 2 Mbyte 100 _B 4 Mbyte 101 _B 8 Mbyte 110 _B Reserved 111 _B Reserved
Res	15:11		Reserved Not Applicable.
SR0S	10:8	rw	SRAM0 Size 000 _B Disable if in the NAND mode 001 _B 512 Kbyte 010 _B 1 Mbyte (default) 011 _B 2 Mbyte 100 _B 4 Mbyte 110 _B Reserved 111 _B Reserved
Res	7:6		Reserved Not Applicable.
SDR1E	5	rw	SDRAM1 Enable The bank1 of SDRAM enable. 0 _B Disable (default) 1 _B Enable (must in the single write)

Field	Bits	Type	Description
Res	4:3		Reserved Not Applicable.
SDRS	2:0	rw	SDRAM Size One bank information, the 2nd bank (SDRAM_CS1) is the same. 000 _B Reserved 001 _B 1M x 32 (4 Mbyte) 010 _B 2M x 32 (8 Mbyte) (suggested setting) 011 _B 4M x 32 (16 Mbyte) 100 _B 16M x 32 (64 Mbyte) 101 _B 32M x 32 (128 Mbyte) 110 _B Reserved 111 _B Reserved

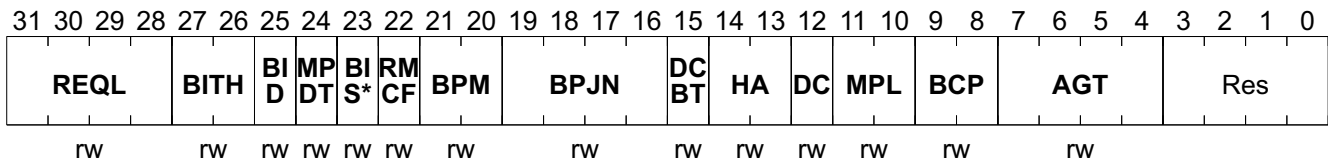
SW_conf
SW_conf
SW Conf
Offset
20_H
Reset Value
402A1010_H

Field	Bits	Type	Description
REQL	31:28	rw	AHB Request Latency The minimum number of cycles between the AHB bus request. 4 _B 4 clocks latency between requests
BITH	27:26	rw	The Threshold of BISS 00 _B Skip if fail 16 (default from pins) 01 _B Skip if fail 48 10 _B Skip if fail 64 11 _B Skip if fail 8 blocks
BID	25	rw	Build-in Self Skip Disable 0 _B Enable skip function (default, from pin A[6])
MPDT	24	rw	MII0 Port Disable was Transmit 0 _B Enable 1 _B Disable was_transmit (good for late CRS PHY, like HPNA2.0 or power-LAN)
BISRD	23	rw	Build-in Self Repair Disable 0 _B Enable skip function (default, from pin A[5])

Field	Bits	Type	Description
RMCF	22	rw	Reserved MC Filtering <i>Note: Reserved MC = 01-80-c2-00-00-00 (BPDU) and 01-80-c2-00-00-02 to 01-80-c2-00-00-0f</i> 0 _B Forwarded 1 _B Filtered
BPM	21:20	rw	Back Pressure Mode 00 _B Disable 01 _B BP jam, the jam number is set by BP_num 10 _B BP jamALL, jam packet until the BP condition is released (default), 11 _B BP carrier, use carrier insertion to do back pressure
BPJN	19:16	rw	Back Pressure Jam Number The consecutive jam time when back pressured. 1010 _B Default value, 10 packet jam then one no-jam
DCBT	15	rw	Disable the Collision Back off Timer 0 _B Follow standard 1 _B Re-transmit immediately after collision
HA	14:13	rw	MAC Address Hashing Algorithm 00 _B Direct mode, using last 10 bits as hashing address 01 _B XOR48 mode 10 _B XOR32 mode 11 _B Reserved
DC	12	rw	Disable Collision 1 _B Disable collision 16 packet abort
MPL	11:10	rw	Maximum Packet Length 00 _B 1536 01 _B 1518 10 _B 1522 11 _B Reserved
BCP	9:8	rw	Broadcast Prevention 00 _B Disable, BC will be blocked 01 _B 64 blocks 10 _B 48 blocks 11 _B 32 blocks
AGT	7:4	rw	Aging Timer 0000 _B Disable age 0001 _B 300 s 0010 _B 600 0111 _B 38400 s 1xxx _B Fast age
Res	3:0		Reserved Not Applicable.

CPUUp_conf

CPUUp_conf Offset Reset Value
CPUUp Conf 24_H 3F3F7E01_H

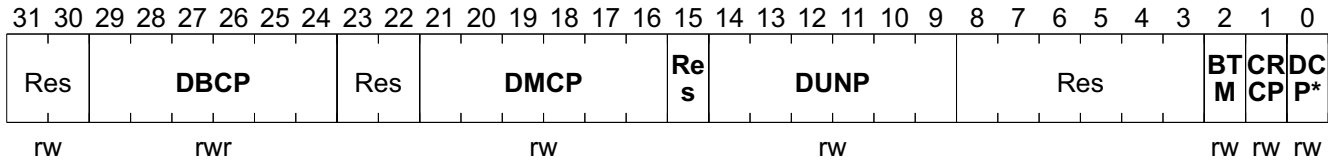

Field	Bits	Type	Description
Res	31:30	rw	Reserved Not Applicable
DBCP	29:24	rwr	Disable Broadcast Packets, from port(s), Forward to CPU The bit [29:24] controls the MII port and PHY port [4:0] respectively. 1 _B Disable sending BC from the MAC port to CPU
Res	23:22		Reserved Not Applicable
DMCP	21:16	rw	Disable Multicast Packets, from Port(s), Forward to CPU The bit [21:16] control the MII port and PHY port [4:0] respectively. 1 _B No send MC from the MAC port to CPU
Res	15		Reserved Not Applicable
DUNP	14:9	rw	Disable Unknown Packets, from Port(s), Forward to CPU The bit [14:9] controls the MII port and PHY port [4:0] respectively. 1 _B No send unknown packet from the MAC port to CPU
Res	8:3		Reserved Not Applicable
BTM	2	rw	Bridge Testing Mode 0 _B Default 1 _B Forwards to CPU if the DA is the port belonging to the other VLAN (for the bridge mode testing).
CRCP	1	rw	CRC Padding from CPU 1 _B The packet from CPU with CRC
DCPUP	0	rw	Disable CPU Port 1 _B Disable the switch CPU port, and so send packets to CPU and clear all the packets in the switch buffer.

CONFIDENTIAL

Ethernet Switch Controller

Port_conf0

Port_conf0	Offset	Reset Value
Port Conf0	28 _H	3F3F3F _H

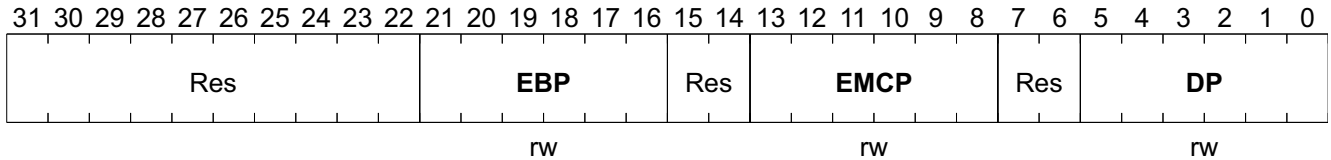

Field	Bits	Type	Description
Res	31:22		Reserved Not Applicable.
EBP	21:16	rw	Enable Back Pressure 1 _B Enable back pressure (but need qualify BP_mode)
Res	15:14		Reserved Not Applicable.
EMCP	13:8	rw	Enable All MC Packet Enable all MC packet broadcast to ports in the same VLAN (not including CPU). 1 _B Enable Layer2 MC broadcast to ports 0 _B do not broadcast MC
Res	7:6		Reserved Not Applicable
DP	5:0	rw	Disable Port 1 _B Port disable (if dumb mode, default = 0)

Port_conf1

Port_conf1	Offset	Reset Value
Port Conf1	2C_H	3F0000_H

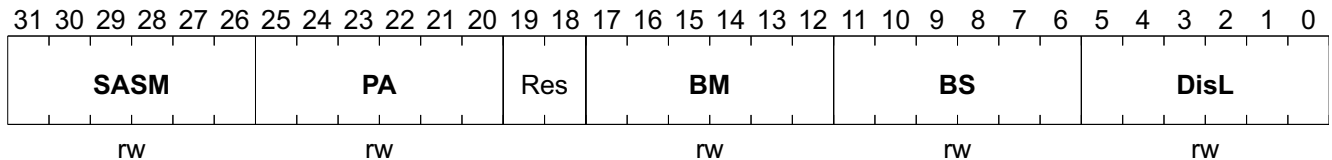

Field	Bits	Type	Description
SASM	31:26	rw	SA Secured Mode Notes 1. Set Dis_Learn and SA_secured at the same time, then only forward the packets with the SA and port number matched. 2. 2. set SA_secured only, then no any secured function 0 _B Don't care SA match 1 _B The packets' SA need match, otherwise discard the packets
PA	25:20	rw	Port Aging 1 _B Enable aging 0 _B Disable aging that the MAC address is belong to Programmed port(s)
Res	19:18		Reserved Not Applicable.
BM	17:12	rw	Blocking Mode If in blocking state. 0 _B Forward all packets to CPU 1 _B Only forward control packets to CPU
BS	11:6	rw	Blocking State Only do the forwarding to CPU, and no learning, and no transmitting (except the packet from CPU). 0 _B Normal state 1 _B Block state
DisL	5:0	rw	Dis Learn Stop SA learning. 0 _B Enable SA learn

Port_conf2

Port_conf2	Offset	Reset Value
Port Conf2	30_H	10C_H

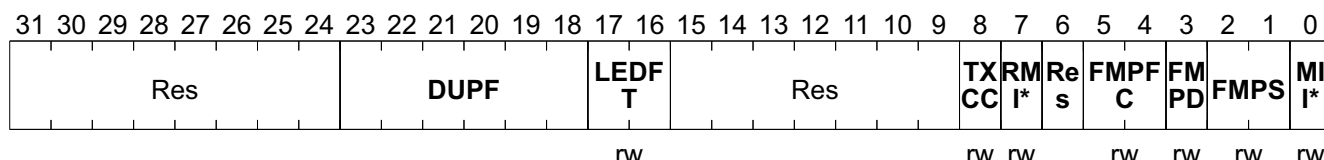

Field	Bits	Type	Description
Res	31:24		Reserved Not Applicable.
DUPF	23:18		Disable Unicast Pause Frame 5:0 00000 _B Default value
LEDFT	17:16	rw	The Frequency of LED Flash 00 _B 30 ms 01 _B 60 ms 10 _B 240 ms 11 _B 480 ms
Res	15:9		Reserved Not Applicable.
TXCC	8	rw	TXC Check Check the MII port TXC period, if more than 400 μs, then disable MII port 0 _B Enable check 1 _B Disable check TXC (only for 10/100M) (default)
RMIIM	7	rw	Reversed MII Mode 0 _B Normal MII mode (default) 1 _B Enable (if in the dumb mode set to 1)
Res	6		Reserved Not Applicable.
FMPFC	5:4	rw	Force MII port FC Force MII port 802.3x flow control ON if AN monitor disable. 00 _B No forced 01 _B Forced the FC of 10M/100M 1x _B Reserved
FMPD	3	rw	Force MII Port Duplex if AN Monitor Disable 0 _B Forced in half duplex 1 _B Forced in full duplex
FMPs	2:1	rw	Force MII Port Speed if AN Monitor Disable 00 _B Force d in 10M 01 _B Forced in 100M 10 _B Reserved 11 _B Reserved

Field	Bits	Type	Description
MIIAN	0	rw	MII Port AN Monitor Enable 0 _B Disable 1 _B Enable MII AN monitor via MDIO (if in the dumb mode, set to 1)

Reserved 1

Res_1	Offset	Reset Value
Reserved 1	34 _H	0 _H

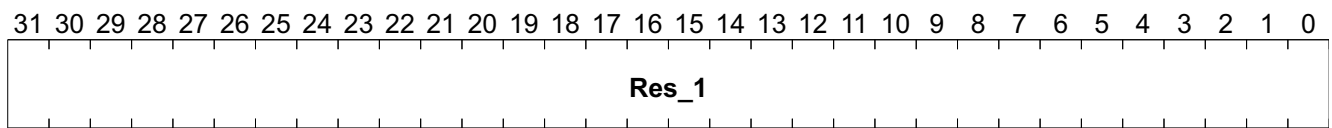

Field	Bits	Type	Description
Res_1	31:0		Reserved Not Applicable.

Reserved 2

Res_2	Offset	Reset Value
Reserved 2	38 _H	0 _H

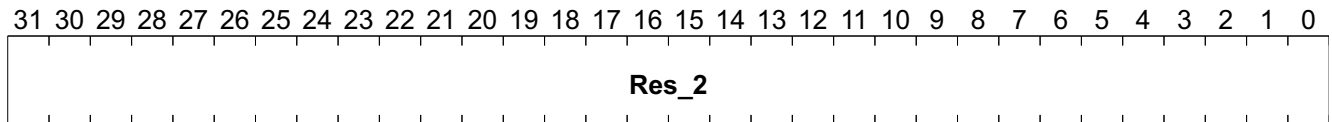

Field	Bits	Type	Description
Res_2	31:0		Reserved Not Applicable.

Reserved 3

Res_3	Offset	Reset Value
Reserved 3	3C _H	0 _H

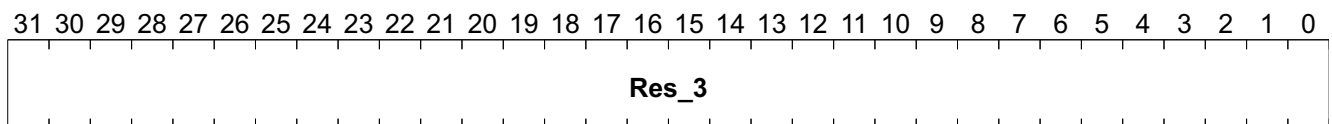

Field	Bits	Type	Description
Res_3	31:0		Reserved Not Applicable.

VLAN Group I

VLAN_GI	Offset	Reset Value
VLAN Group I	40_H	7F_H

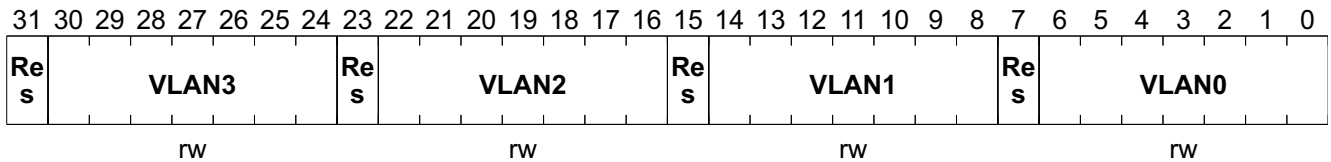

Field	Bits	Type	Description
Res	31		Reserved Not Applicable.
VLAN3	30:24	rw	VLAN Group 3 The ports in VLAN group 3, 0000000
Res	23		Reserved Not Applicable.
VLAN2	22:16	rw	VLAN Group 2 The ports in VLAN group 2, 0000000
Res	15		Reserved Not Applicable.
VLAN1	14:8	rw	VLAN Group 1 The ports in VLAN group 1, 0000000
Res	7		Reserved Not Applicable.
VLAN0	6:0	rw	VLAN Group 0 The ports in VLAN group 0, the 6 th bit is CPU port. 111111 _B All ports in the VLAN group 0

VLAN Group II

VLAN_GII Offset Reset Value
 VLAN Group II 44_H 0_H

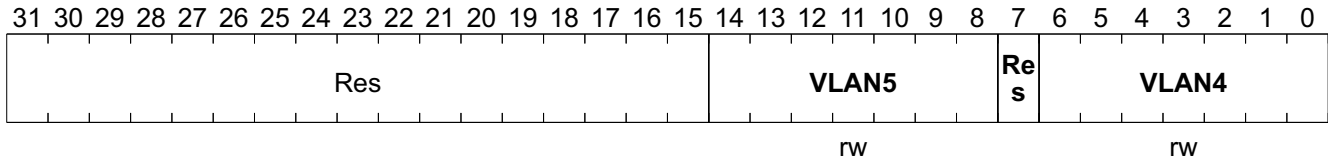

Field	Bits	Type	Description
Res	31:15		Reserved Not Applicable.
VLAN5	14:8	rw	VLAN Group 5 The ports in VLAN group 5, 0000000
Res	7		Reserved Not Applicable.
VLAN4	6:0	rw	VLAN Group 4 The ports in VLAN group 4, 0000000

Send Trigger

Send_trig Offset Reset Value
 Send Trigger 48_H 0_H

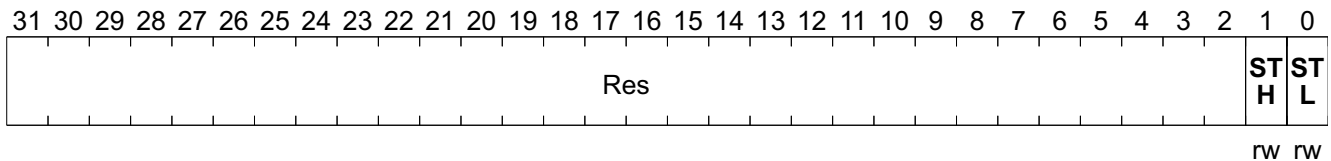

Field	Bits	Type	Description
Res	31:2		Reserved Not Applicable.
STH	1	rw	Send Trigger High CPU Send packet to LAN/WAN DMA trigger (high priority), self_clear
STL	0	rw	Send Trigger Low CPU Send packet to LAN/WAN DMA trigger (normal priority), self_clear

Search CMD

Srch_cmd	Offset	Reset Value
Search CMD	4C_H	0_H

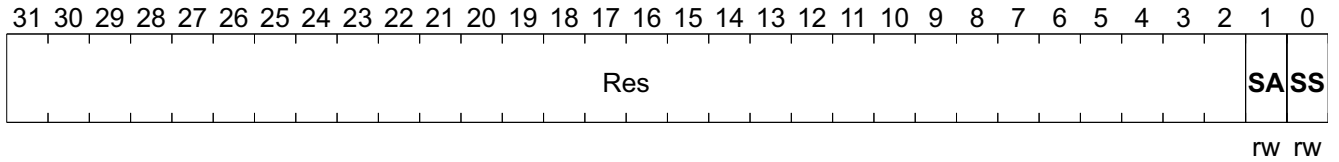

Field	Bits	Type	Description
Res	31:2		Reserved Not Applicable.
SA	1	rw	Search Again Search for the next available address, self_clear (program again after data_rdy).
SS	0	rw	Search Start Searching from the start of address table, self_clear.

Address ST0

ADDR_st0	Offset	Reset Value
Address ST0	50_H	0_H

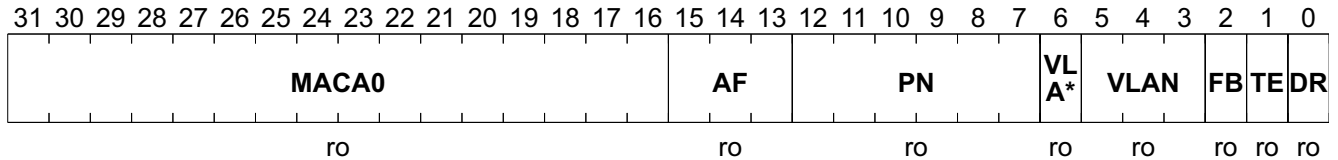

Field	Bits	Type	Description
MACA0	31:16	ro	MAC Address 15:0
AF	15:13		Age Field 000 _B Empty 001 to 110 _B Existing MAC 111 _B Static address
PN	12:7		Port Map Number Port number (refer to B+58, bit7-12)
VLANE	6		VLAN Field is Enabled
VLAN	5:3		VLAN Number
FB	2		Filter Bit
TE	1		Search to Table End 1 _B Hit the end of MAC address table
DR	0		Data is Ready ADDR_st, ADDR_srch0 and ADDR_srch1 are ready, read_clear

ADDR St1

ADDR_st1 **Offset** **Reset Value**
Address St1 **54_H** **0_H**

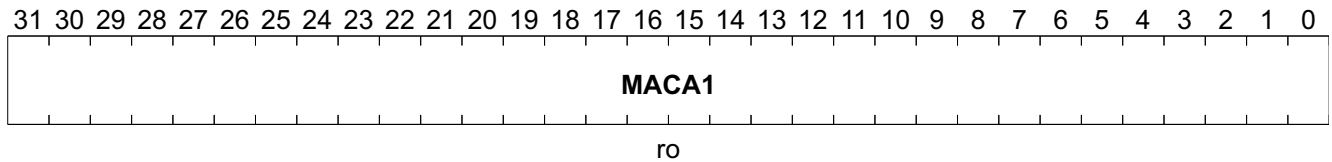

Field	Bits	Type	Description
MACA1	31:0	ro	MAC Address 47:16

MAC Write Address 0

MAC_wt0 **Offset** **Reset Value**
MAC Write Address 0 **58_H** **0_H**

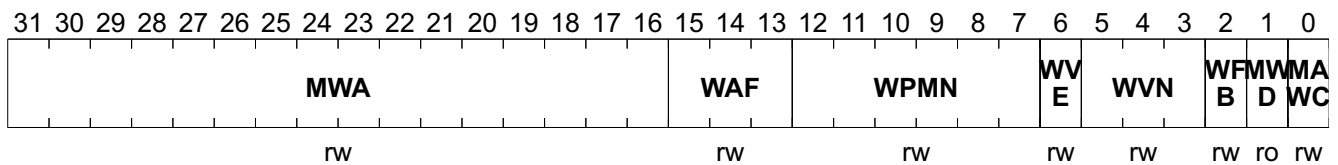

Field	Bits	Type	Description
MWA	31:16	rw	MAC Write Address 15:0
WAF	15:13	rw	Write Age Field 000 _B Empty 001 to 110 _B Existed MAC 111 _B Static address
WPMN	12:7	rw	Write Port Map Number
WVE	6	rw	Write VLAN Enable
WVN	5:3	rw	Write VLAN Number
WFB	2	rw	Write Filter Bit
MWD	1	ro	MAC Write Done 1 _B MAC address write complete, read_clear
MAWC	0	rw	MAC Address Write Command 1 _B The MAC write data is ready and write to MAC table, self_clear

MAC Write Address 1

MAC_wt1 **Offset** **Reset Value**
MAC Write Address 1 **5C_H** **0_H**

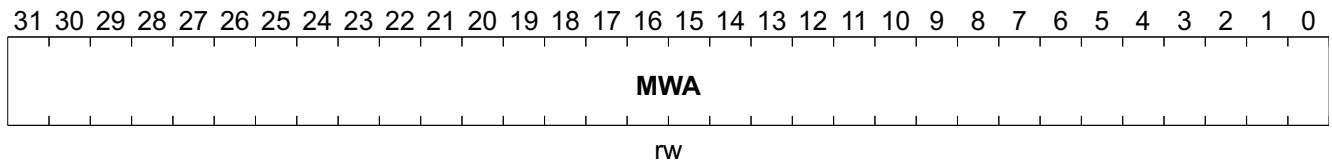

Field	Bits	Type	Description
MWA	31:0	rw	MAC Write Address 47:16

Bandwidth Control 0

BW_cntl0 **Offset** **Reset Value**
Bandwidth Control 0 **60_H** **0_H**

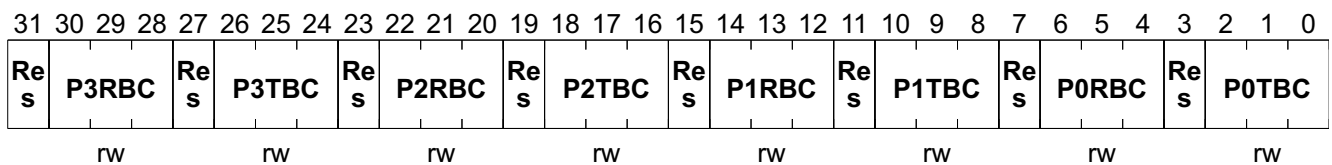

Field	Bits	Type	Description
Res	31		Reserved Not Applicable.
P3RBC	30:28	rw	Port 3 Receive Bandwidth Control 000 _B Disable 001 _B 64K bit per second 010 _B 128K bit per second 011 _B 256K bit per second 100 _B 512K bit per second 101 _B 1M bit per second 110 _B 4M bit per second 111 _B 10M bit per second
Res	27		Reserved Not Applicable.

Field	Bits	Type	Description
P3TBC	26:24	rw	Port 3 Transmit Bandwidth Control 000 _B Disable 001 _B 64K bit per second 010 _B 128K bit per second 011 _B 256K bit per second 100 _B 512K bit per second 101 _B 1M bit per second 110 _B 4M bit per second 111 _B 10M bit per second
Res	23		Reserved Not Applicable.
P2RBC	22:20	rw	Port 2 Receive Bandwidth Control Please refer to P3RBC for bandwidth define.
Res	19		Reserved Not Applicable.
P2TBC	18:16	rw	Port 2 Transmit Bandwidth Control Please refer to P3RBC for bandwidth define.
Res	15		Reserved Not Applicable.
P1RBC	14:12	rw	Port 1 Receive Bandwidth Control Please refer to P3RBC for bandwidth define.
Res	11		Reserved Not Applicable.
P1TBC	10:8	rw	Port 1 Transmit Bandwidth Control Please refer to P3RBC for bandwidth define.
Res	7		Reserved Not Applicable.
P0RBC	6:4	rw	Port 0 Receive Bandwidth Control Please refer to P3RBC for bandwidth define.
Res	3		Reserved Not Applicable.
P0TBC	2:0	rw	Port 0 Transmit Bandwidth Control 000 _B Disable 001 _B 64K bit per second 010 _B 128K bit per second 011 _B 256K bit per second 100 _B 512K bit per second 101 _B 1M bit per second 110 _B 4M bit per second 111 _B 10M bit per second

Bandwidth Control 1

BW_cntl1	Offset	Reset Value
Bandwidth Control 1	64 _H	0 _H

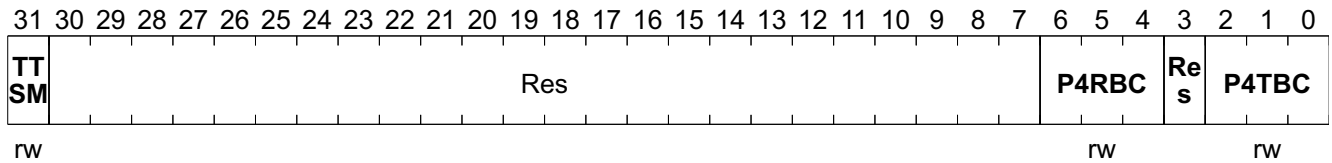

Field	Bits	Type	Description
TTSM	31	rw	The Transmit Traffic Shaper Mode 0 _B Best effort mode (default) 1 _B Average Inter Packet Gap (IPG) in the 1 second period
Res	30:7		Reserved Not Applicable.
P4RBC	6:4	rw	Port 4 Receive Bandwidth Control Please refer to P3RBC for bandwidth define.
Res	3		Reserved Not Applicable.
P4TBC	2:0	rw	Port 4 Transmit Bandwidth Control Please refer to P3RBC for bandwidth define.

PHY Control 0

PHY_cntl0	Offset	Reset Value
PHY Control 0	68_H	0_H

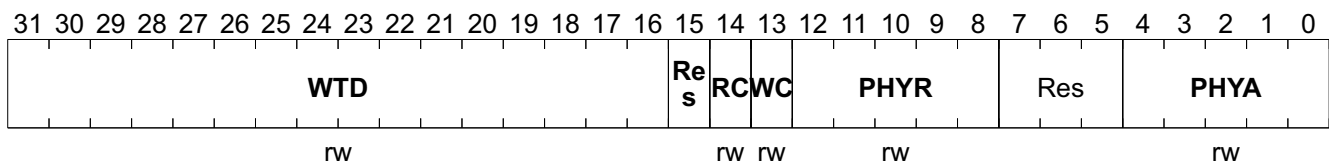

Field	Bits	Type	Description
WTD	31:16	rw	The Data be Written into the PHY
Res	15		Reserved Not Applicable.
RC	14	rw	Read Command, self_clear
WC	13		Write Command, self_clear
PHYR	12:8		PHY Register Address
Res	7:5		Reserved Not Applicable.
PHYA	4:0	rw	PHY Address

PHY Control 1

PHY_cntl1	Offset	Reset Value
PHY Control 1	6C_H	0_H

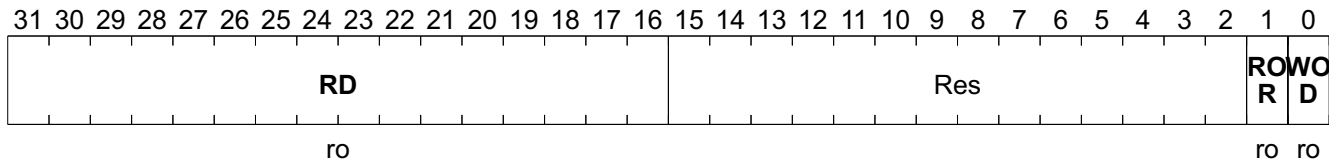

Field	Bits	Type	Description
RD	31:16	ro	The Read Data
Res	15:2		Reserved Not Applicable.
ROR	1	ro	Read Operation is Complete and Data is Ready, read_clear
WOD	0		Write Operation is Done, read_clear

Switch Control Threshold

*Note: The working global thresholds = (register value) * 2, The Drop1_set[7:0] threshold default value = 137 blocks, The default working Drop1_set threshold = 137 x 2 = 274.*

FC_th	Offset	Reset Value
Switch Control Threshold	70_H	DC866A_H

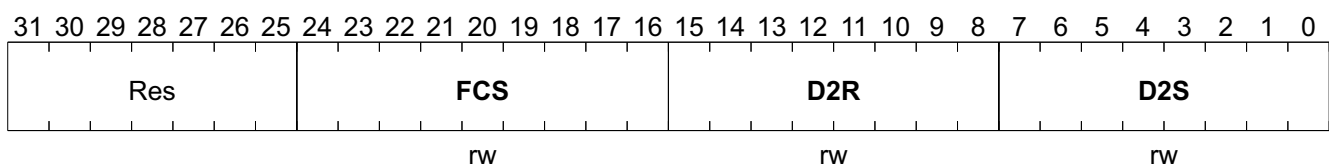

Field	Bits	Type	Description
Res	31:25		Reserved Not Applicable.
FCS	24:16	rw	Switch Flow Control Set Threshold, 220 Free Blocks
D2R	15:8		Switch Drop 2 Release Threshold, 134 Free Blocks
D2S	7:0		Switch Drop 2 Set Threshold, 106 Free Blocks

Adj Port Threshold

adj_port_th	Offset	Reset Value
Adj Port Threshold	74_H	10C2033_H

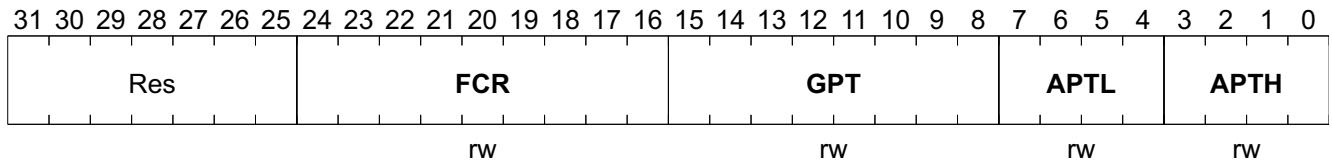

Field	Bits	Type	Description
Res	31:25		Reserved Not Applicable.
FCR	24:16	rw	Switch Flow Control Release Threshold, 268 Free Blocks
GPT	15:8	rw	Giga Port Buffer Threshold, 32 Occupied Blocks
APTL	7:4	rw	Per Port Guaranteed High Priority pkt, 3 Blocks
APTH	3:0		Per Port Guaranteed Normal Priority pkt, 3 Blocks

Port Threshold

Port_th **Offset** **Reset Value**
Port Threshold **78_H** **8478300D_H**

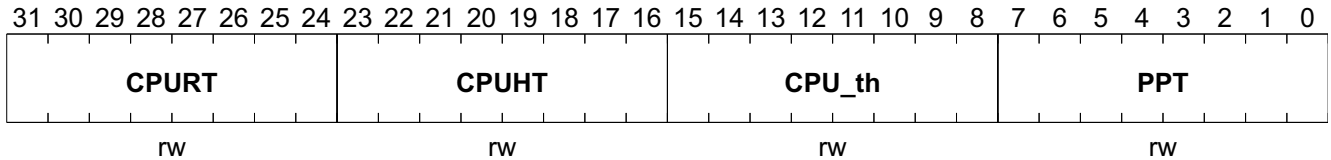

Field	Bits	Type	Description
CPURT	31:24	rw	The CPU Hold Release Threshold, Default 132 Free Block
CPUHT	23:16		The CPU Hold Threshold for All Ports, Default 120 Free Block
CPU_th	15:8		CPU Port Buffer Threshold, 48 Occupied Blocks
PPT	7:0		Per Port Buffer Threshold, 13 Occupied Blocks

PHY Control 2

PHY_cntl2 **Offset** **Reset Value**
PHY Control 2 **7C_H** **BE0FFFFFF_H**

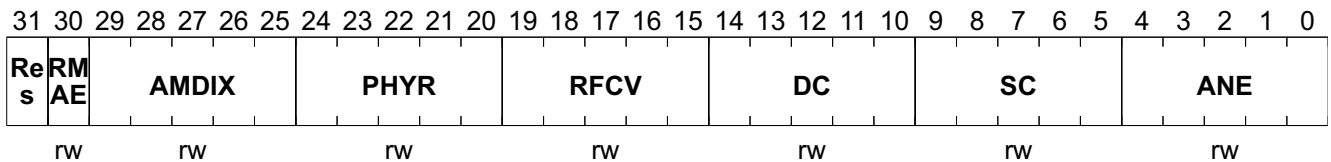

Field	Bits	Type	Description
Res	31		Reserved Not Applicable.

Field	Bits	Type	Description
RMAE	30	rw	Recommend MCC Average Enable Per port PHY auto MDIX enable. 0 _B Default value
AMDIX	29:25		Auto MDIX enable <i>Note: [25] = port0, [26] = port 1 etc...</i> 0 _B disable auto MDIX. 1 _B enable auto MDIX. (default)
PHYR	24:20		PHY Reset <i>Note: [20] = port0, [21] = port 1 etc...</i> 0 _B Reset(default) 1 _B Normal
RFCV	19:15		Recommended FC Value (reg4, bit10) <i>Note: [15] = port0, [16] = port 1 etc...</i> 0 _B No forced 1 _B FC_rec ON
DC	14:10		Duplex Control <i>Note: [10] = port0, [11] = port 1 etc...</i> 0 _B Half 1 _B Full
SC	9:5		Speed Control <i>Note: [5] = port0, [6] = port 1 etc...</i> 0 _B 10M 1 _B 100M
ANE	4:0		Auto Negotiation Enable <i>Note: [0] = port0, [1] = port 1 etc...</i> 1 _B Enable

PHY Control 3

PHY_cntl3	Offset	Reset Value
PHY Control 3	80_H	1420B_H

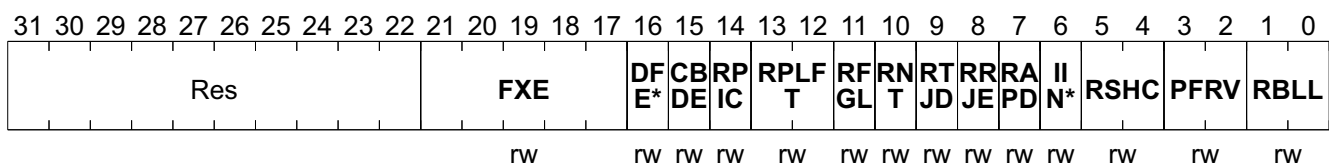

Field	Bits	Type	Description
Res	31:22		Reserved Not Applicable.

Field	Bits	Type	Description
FXE	21:17	rw	Per Port FX Enable <i>Note: [17] = port0, [18] = port 1 etc...</i> 0 _B Default value, disable 1 _B Enable FX
DFEFI	16		Disable far_end Fault Indication
CBDE	15		Recommend Cable Broken Detect Enable
RPIC	14		Recommend Polarity LIU/LID Interval Check
RPLFT	13:12		Recommend Polarity Link Fail Timer Select 00 _B Default value (2 sec.) 01 _B 3 sec. 10 _B 4 sec. 11 _B 8 sec.
RFGL	11		Recommend Force Good Link
RNT	10		Recommend Normal Threshold
RTJD	9		Recommend Transmit Jabber Disable
RRJE	8		Recommend Receive Jabber Enable
RAPD	7		Recommend Auto Polarity Disable
IINSEL	6		IINSEL 0 _B Default value
RSHC	5:4		Recommend Sample-Hold Current
PFRV	3:2		Pre-filter Recommend Value
RBLL	1:0		Recommend Base-line Limit

Priority Control

Pri_cntl Offset **Reset Value**
Priority Control **84_H** **0_H**

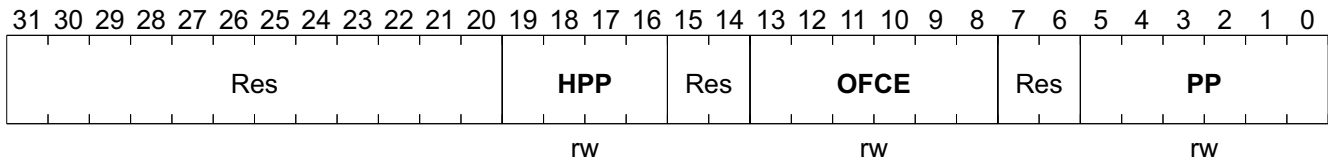

Field	Bits	Type	Description
Res	31:20		Reserved Not Applicable.
HPP	19:16	rw	The Proportion of Normal and High Priority Packet The transmit ratio between high/low queue will be 8xN:1, N is the value. 0000 _B Unlimited 0001 _B 8:1 0010 _B 16:1 0011 _B 24:1,...etc

Field	Bits	Type	Description
Res	15:14		Reserved Not Applicable.
OFCE	13:8	rw	Auto-turn-off FC Auto-turn-off FC when the programmed ports receive priority packet. <i>Note: [8] = port0, [9] = port 1 etc...</i> 0 _B Disable
Res	7:6		Reserved Not Applicable.
PP	5:0	rw	Port Priority Force all the packet from the programmed port(s) are priority. <i>Note: [0] = port0, [1] = port 1 etc...</i> 0 _B Normal 1 _B high priority

VLAN Priority

VLAN_pri **Offset** **Reset Value**
VLAN Priority **88_H** **400_H**

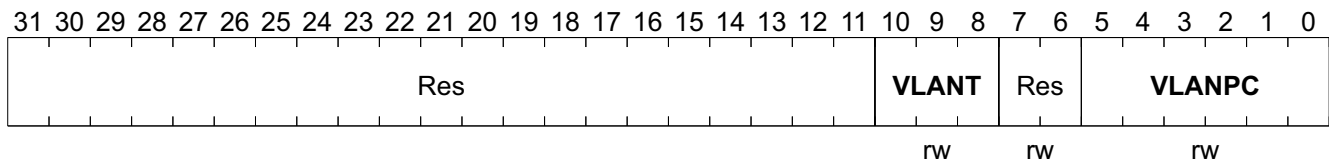

Field	Bits	Type	Description
Res	31:11		Reserved Not Applicable.
VLANT	10:8	rw	VLAN High Priority Threshold If the priority field in VLAN tag is not less than this threshold, then the packet is high priority. else it is low priority. 100 _B Default value
Res	7:6		Reserved Not Applicable.
VLANPC	5:0		Enable VLAN Priority Check <i>Note: [0] = port0, [1] = port 1 etc...</i> 0 _B Disable

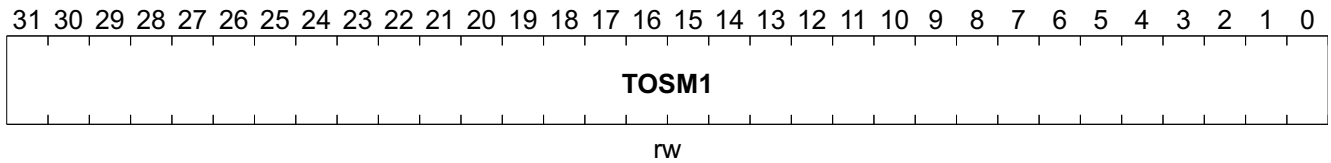

Field	Bits	Type	Description
TOSM1	31:0	rw	TOS Bit Map 64:32

Custom Priority 1

Custom_pri1 **Offset**
Custom Priority 1 **98_H** **Reset Value**
0_H

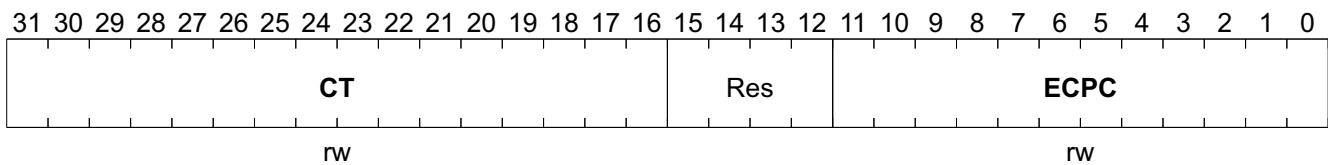

Field	Bits	Type	Description
CT	31:16	rw	Custom Type This field defines the value of Customer Type that will be matched at the Type field of ether packets.
Res	15:12		Reserved Not Applicable.
ECPC	11:0	rw	Enable Custom Packet Check <i>Note: Enable custom packet check :bit [1:0] for port0, [3:2] for port1, [5:4] for port2,</i> 00 _B Disable, default 01 _B Treat as high priority 10 _B Filtered 11 _B Reserved

Custom Priority 2

Custom_pri2 **Offset**
Custom Priority 2 **9C_H** **Reset Value**
0_H

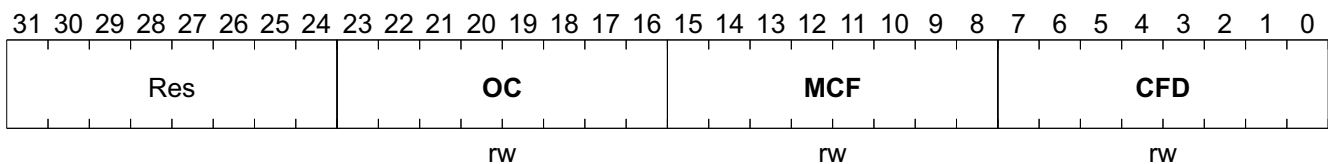

Field	Bits	Type	Description
Res	31:24		Reserved Not Applicable.
OC	23:16	rw	Offset Count from SA 7:0 This offset defines that the data will be extracted from the packets. The data will be compared with the Custom Field and Mask. The offset is counted from SA0 field of packet. If VLAN type found, it will add 4-byte automatically.
MCF	15:8		Mask of Custom Field The mask data for the Custom Field.
CFD	7:0		Custom Field Define This data defines the Custom Field that will be treated as higher priority or filtered.

PHY Control 4

PHY_cntl4 Offset Reset Value
 PHY Control 4 A0_H 0_H

31	30	29	28	27	26	25	24	23	22	21	20	19	18	17	16	15	14	13	12	11	10	9	8	7	6	5	4	3	2	1	0		
Res										RC 25	V2 3	Re s	P4 CB	P4CB L	Re s	P3 CB	P3CB L	Re s	P2 CB	P2CB L	Re s	P1 CB	P1CB L	Re s	P0 CB	P0CB L							
											rw	rw	ro	ro	ro	ro	ro	ro	ro	ro	ro	ro	ro	ro	ro	ro	ro	ro	ro	ro	ro	ro	ro

Field	Bits	Type	Description
Res	31:22		Reserved Not Applicable.
RC25	21	rw	Rom Code 25 0 _B 2.2 V (default) 1 _B Fix the ROM code to 2.5 V
V23	20	rw	Volt 23 0 _B 2.2 V (default) 1 _B 10BaseT voltage 2.3 V
Res	19		Reserved Not Applicable.
P4CB	18	ro	Port 4 Cable Broken
P4CBL	17:16	ro	Port 4 Cable Broken Length
Res	15		Reserved Not Applicable.
P3CB	14	ro	Port 3 Cable Broken
P3CBL	13:12	ro	Port 3 Cable Broken Length
Res	11		Reserved Not Applicable.
P2CB	10	ro	Port 2 Cable Broken
P2CBL	9:8	ro	Port 2 Cable Broken Length
Res	7		Reserved Not Applicable.
P1CB	6	ro	Port 1 Cable Broken
P1CBL	5:4	ro	Port 1 Cable Broken Length
Res	3		Reserved Not Applicable.
P0CB	2	ro	Port 0 Cable Broken
P0CBL	1:0	ro	Port 0 Cable Broken Length

Empty Control

Empty_cnt **Offset** **Reset Value**
Empty Control **A4_H** **0_H**

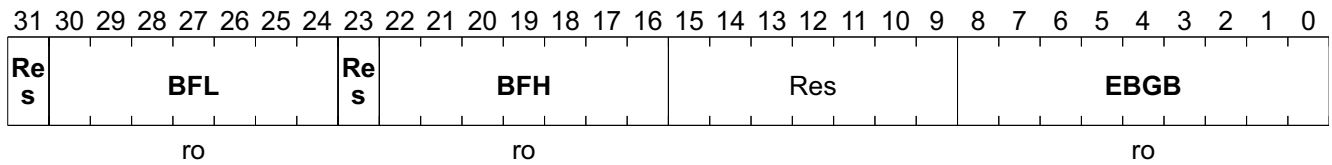

Field	Bits	Type	Description
Res	31		Reserved Not Applicable.
BFL	30:24	ro	Low-pri Out-queue Full status for CPU and Port[5:0]
Res	23		Reserved Not Applicable.
BFH	22:16	ro	The High-pri Out-queue Full status for CPU and Port[5:0]
Res	15:9		Reserved Not Applicable.
EBGB	8:0	ro	Empty Block in the Global Buffer

CONFIDENTIAL

Ethernet Switch Controller

Port Control Select

Port_cnt_sel	Offset	Reset Value
Port Control Select	A8 _H	0 _H

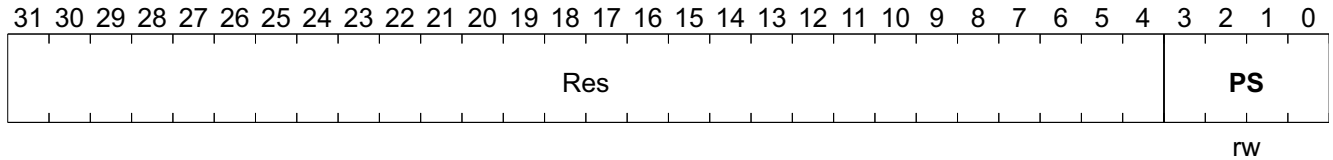

Field	Bits	Type	Description
Res	31:4		Reserved Not Applicable.
PS	3:0	rw	Port Selected for the port_cnt

Port Controller

Port_cnt Port Controller	Offset AC _H	Reset Value 0 _H
-----------------------------	---------------------------	-------------------------------

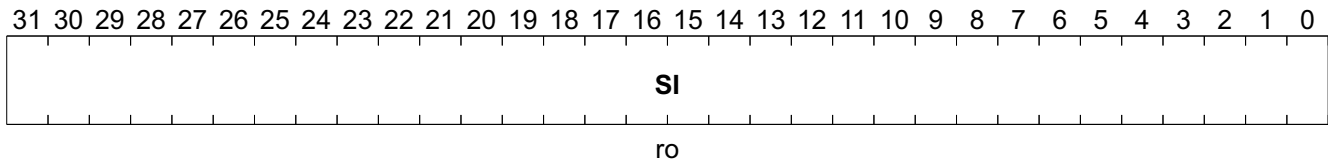

Field	Bits	Type	Description
SI	31:0	ro	Sel Info If port_sel=0, [24:16] port0 high packet count [8:0] port0 low packet count If port_sel=1, [24:16] port1 high packet count [8:0] port1 low packet count If port_sel=2, [24:16] port2 high packet count [8:0] port2 low packet count If port_sel=3, [24:16] port3 high packet count [8:0] port3 low packet count If port_sel=4, [24:16] port4 high packet count [8:0] port4 low packet count If port_sel=5, [24:16] port5 high packet count [8:0] port5 low packet count If port_sel=6, [24:16] port6 high packet count [8:0] port6 low packet count If port_sel=7, [24:16] port7 high packet count [8:0] port7 low packet count If port_sel=9, [8:0] flow control status If port_sel=10, [24:16] testing [8:0] ever flow control port If port_sel=11, [24:16] no_pkt status [7:0] no_pkt_status If port_sel=12, [24:16] receive bandwidth control port, [8:0] transmit bandwidth control port

Int St

Note: All bits are "write 1 clear"

Int_st	Offset	Reset Value
Int St	B0_H	0_H

31	30	29	28	27	26	25	24	23	22	21	20	19	18	17	16	15	14	13	12	11	10	9	8	7	6	5	4	3	2	1	0
Res							CP UH	SD E	RD E	W1 TE	W0 TE	IP	PS C	Re s	BC SS	MD	GE T	CP UP	Re s	P5 QF	P4 QF	P3 QF	P2 QF	P1 QF	P0 QF	LD F	HD F	RX LD	RX HD	SL D	SH D
							rw	rw	rw	rw	rw	rw	rw	rw	rw	rw	rw	rw	rw	rw	rw	rw	rw	rw	rw	rw	rw	rw	rw	rw	rw

Field	Bits	Type	Description
Res	31:25		Reserved Not Applicable.
CPUH	24	rw	CPU Send Packets are Hold in Descriptor Write one clear the status.
SDE	23		Send Descriptor Error Write one clear the status.
RDE	22		Receive Descriptor Error Write one clear the status.
W1TE	21		Watchdog1 Timer Expired Write one clear the status.
W0TE	20		Watchdog0 Timer Expired Write one clear the status.
IP	19		Any Secured Port has Intruder Packets Write one clear the status.
PSC	18		Port Status Change Any port change the link status (link-up to/from link-down). Write one clear the status.
Res	17		Reserved Not Applicable.
BCSS	16	rw	Accumulated BC Count over BC_storm Setting Write one clear the status.
MD	15		Must Drop All the buffer almost full. Write one clear the status.
GET	14		Global empty-th Write one clear the status.
CPUP	13		CPU Port Meet the CPU port pre-th & global empty-th. Write one clear the status.
Res	12		Reserved Not Applicable.

Field	Bits	Type	Description
P5QF	11	rw	Meet the Port5 port-th & global empty-th Write one clear the status.
P4QF	10		Meet the Port4 port-th & global empty-th Write one clear the status.
P3QF	9		Meet the Port3 port-th & global empty-th Write one clear the status.
P2QF	8		Meet the Port2 port-th & global empty-th Write one clear the status.
P1QF	7		Meet the Port1 port-th & global empty-th Write one clear the status.
P0QF	6		Meet the Port0 port-th & global empty-th Write one clear the status.
LDF	5		Descriptor, "normal priority receive", are Full Write one clear the status.
HDF	4		Descriptor, "high priority receive", are Full Write one clear the status.
RXLD	3		DMA Receive one Normal Priority Packet to CPU Write one clear the status.
RXHD	2		DMA Receive one High Priority Packet to CPU Write one clear the status.
SLD	1		DMA Send one Normal Priority Packet to Switch Write one clear the status.
SHD	0		DMA Send one High Priority Packet to Switch Write one clear the status.

Interrupt Mask

Note: 1: Mask the interrupt

Int_mask	Offset	Reset Value
Interrupt Mask	B4_H	1FDEFFF_H

31	30	29	28	27	26	25	24	23	22	21	20	19	18	17	16	15	14	13	12	11	10	9	8	7	6	5	4	3	2	1	0				
Res							CPS	SDR	RDW	W0	MI	PS	Re	BC	MD	GQ	CP	Re	P5	P4	P3	P2	P1	P0	LD	HD	RL	RH	SL	SH					
							UH	E	E	TE	TE	C	s	S		F	U	s	QF	QF	QF	QF	QF	QF	F	F	D	D	D	D					
							rw	rw	rw	rw	rw	rw	rw	rw	rw	rw	rw	rw	rw	rw	rw	rw	rw	rw	rw	rw	rw	rw	rw	rw	rw	rw	rw	rw	rw

Field	Bits	Type	Description
Res	31:25		Reserved Not Applicable.

Field	Bits	Type	Description
CPUH	24	rw	Mask CPU Hold
SDE	23		Mask Send Description Error
RDE	22		Mask Receive Description Error
W1TE	21		Mask Wachdog1 Timer Expired
W0TE	20		Mask Wachdog0 Timer Expired
MI	19		Mask Intruder
PSC	18		Mask Port Status Change
Res	17		Reserved Not Applicable.
BCS	16	rw	Mask BC Storm
MD	15		Mast Drop
GQF	14		Mask Global Queue Full
CPUQ	13		Mask CPU Queue Full
Res	12		Reserved Not Applicable.
P5QF	11	rw	Mask Port5 Queue Full
P4QF	10		Mask Port4 Queue Full
P3QF	9		Mask Port3 Queue Full
P2QF	8		Mask Port2 Queue Full
P1QF	7		Mask Port1 Queue Full
P0QF	6		Mask Port0 Queue Full
LDF	5		Mask Low Descriptor Full
HDF	4		Mask High Descriptor Full
RLD	3		Mask Receive Low Done
RHD	2		Mask Receive High Done
SLD	1		Mask Send Low Done
SHD	0	Mask Send High Done	

GPIO Conf 0

GPIO_conf0	Offset	Reset Value
GPIO Conf 0	B8_H	FF_H

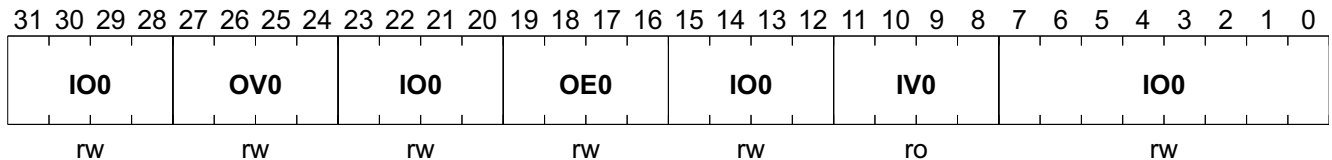

Field	Bits	Type	Description
IO0	31:28	rw	Reserved
OV0	27:24	rw	GPIO 3:0, Output Value if the Output Enable is one
IO0	23:20	rw	Reserved
OE0	19:16	rw	GPIO 3:0, Output Enable control 0 _B Input (default) 1 _B Output Enable
IO0	15:12	rw	Reserved
IV0	11:8	ro	GPIO 3:0, Input Value if in the Input Mode
IO0	7:0	rw	Reserved

GPIO Conf 2

GPIO_conf2	Offset	Reset Value
GPIO Conf 2	BC_H	0_H

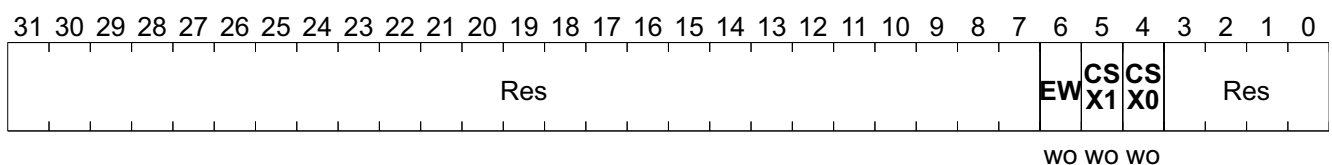

Field	Bits	Type	Description
Res	31:7		Reserved Not Applicable.
EW	6	wo	Enable Wait State 0 _B Disable wait state for external IO control CSX0 and CSX1(default) 1 _B Enable the wait state pin GPIO[0] for external IO control CSX0 and CSX1
CSX1	5	wo	Enable CSX1in GPIO 3 0 _B Disable the CSX1 function(default) 1 _B Enable the CSX1 function

Field	Bits	Type	Description
CSX0	4	wo	Enable CSX0, INTX0 Interface in GPIO 1:2 0 _B Disable the CSX0/INTX0 function.(default) 1 _B Enable the CSX0 and INTX0 function
Res	3:0		Reserved Not Applicable.

Watchdog 0

Wdog_0 **Offset** **Reset Value**
Watchdog 0 **C0_H** **7FFF0000_H**

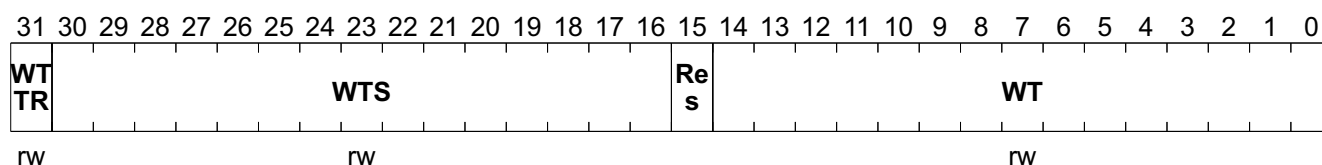

Field	Bits	Type	Description
WTTR	31	rw	Watchdog Timer Trigger Reset 0 _B Disable(default) 1 _B Reset the whole chip if watchdog timer is expired
WTS	30:16	rw	Watchdog Timer Set The time out setting of timer, if timer set is equal to timer, then it means that the timer is expired. Maximum 32767.
Res	15		Reserved Not Applicable.
WT	14:0	rw	Watchdog Timer Count up timer, mask-able, read clear, unit 10 ms. If reach timer set mean time up and keep the counter until read-clear by software, maximum 327 s.

Watchdog 1

Wdog_1	Offset	Reset Value
Watchdog 1	C4_H	7FFF0000_H

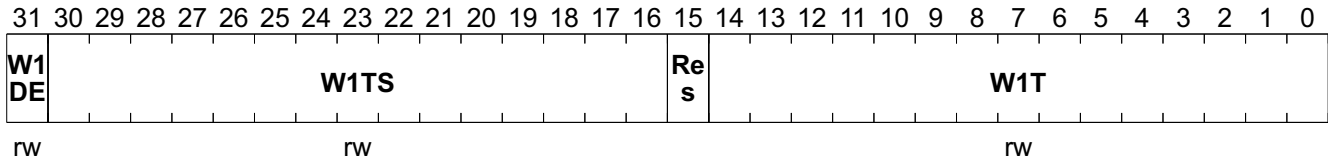

Field	Bits	Type	Description
W1DE	31	rw	Watchdog Timer Stop CPU Port Receiving No issue flow control in ports. Auto-recover when the timer is cleaned. 0 _B Disable(default) 1 _B Force all to CPU packets drop if timer is expired, and no issue flow control in ports. Auto-recover when the timer is cleaned
W1TS	30:16	rw	Watchdog 1 Timer Set The time out setting of the timer, if timer set is equal to timer, then it means that the timer is expired. Maximum 32767.
Res	15		Reserved Not Applicable.
W1T	14:0	rw	Watchdog 1 Timer Count up timer, mask-able, read clear, unit 10 ms. If reach timer set mean time up and keep the counter until read-clear by software, maximum 327 s.

Swap In

Swap_in **Offset**
Swap In **C8_H** **Reset Value**
0_H

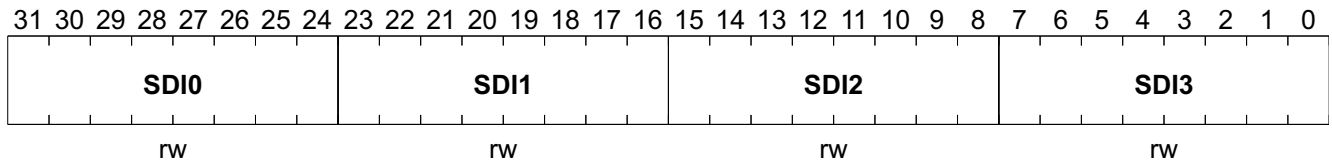

Field	Bits	Type	Description
SDI0	31:24	rw	Swap_in 31:24 = Swap_out 7:0
SDI1	23:16		Swap_in 23:16 = Swap_out 15:8
SDI2	15:8		Swap_in 15:8 = Swap_out 15:8
SDI3	7:0		Swap_in 7:0 = Swap_out 31:24

Swap Out

Swap_out **Offset**
Swap Out **CC_H** **Reset Value**
0_H

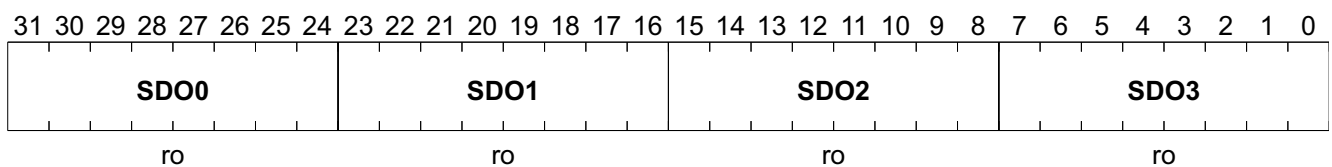

Field	Bits	Type	Description
SDO0	31:24	ro	Swap_out 31:24 = Swap_in 7:0
SDO1	23:16		Swap_out 23:16 = Swap_in 15:8
SDO2	15:8		Swap_out 15:8 = Swap_in 23:16
SDO3	7:0		Swap_out 7:0 = Swap_in 31:24

Send High Base Address

send_Hbaddr **Offset**
Send High Base Address **D0_H** **Reset Value**
0_H

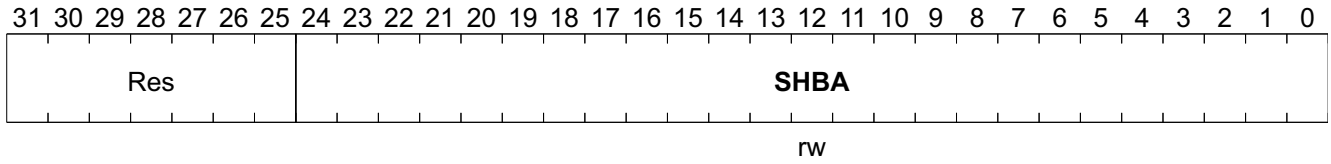

Field	Bits	Type	Description
Res	31:25		Reserved Not Applicable.
SHBA	24:0	rw	The Descriptor Base Address of CPU_to_SW (high priority)

Send Low Base Address

send_Lbaddr	Offset	Reset Value
Send Low Base Address	D4_H	0_H

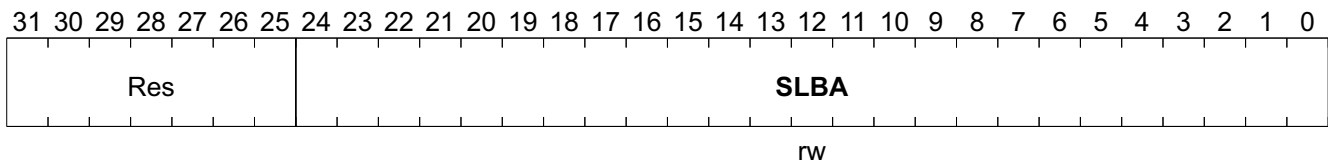

Field	Bits	Type	Description
Res	31:25		Reserved Not Applicable.
SLBA	24:0	rw	The Descriptor Base Address of CPU_to_SW (normal priority)

Receive High Base Address

rec_Hbaddr Offset Reset Value
 Receive High Base Address D8_H 0_H

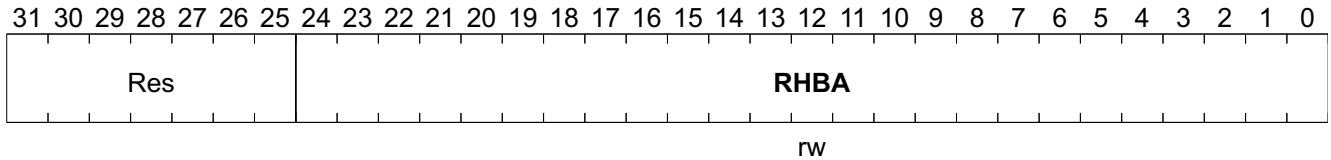

Field	Bits	Type	Description
Res	31:25		Reserved Not Applicable.
RHBA	24:0	rw	The Descriptor Base Address of SW_to_CPU (high priority)

Receive Low Base Address

rec_Lbaddr Offset Reset Value
 Receive Low Base Address DC_H 0_H

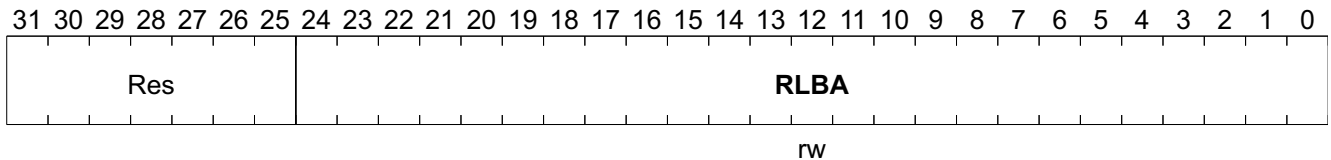

Field	Bits	Type	Description
Res	31:25		Reserved Not Applicable.
RLBA	24:0	rw	The Descriptor Base Address of SW_to_CPU (normal priority)

Send High Working Address

send_Hwaddr	Offset	Reset Value
Send High Working Address	E0_H	0_H

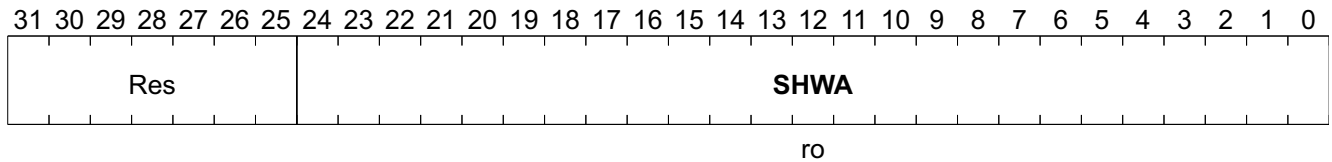

Field	Bits	Type	Description
Res	31:25		Reserved Not Applicable.
SHWA	24:0	ro	The Descriptor WORKING Address of CPU_to_SW (high priority)

Send Low Working Address

send_Lwaddr	Offset	Reset Value
Send Low Working Address	E4_H	0_H

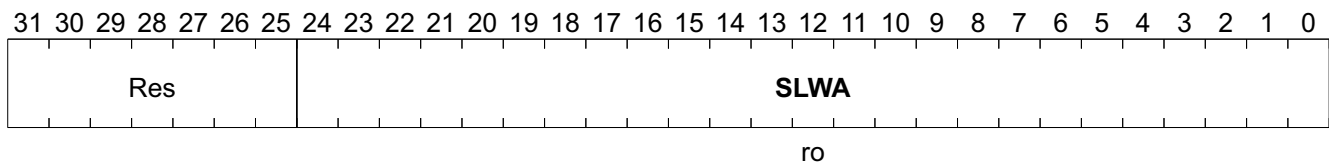

Field	Bits	Type	Description
Res	31:25		Reserved Not Applicable.
SLWA	24:0	ro	The Descriptor WORKING Address of CPU_to_SW (normal priority)

Receive High Working Address

rec_Hwaddr **Offset** **Reset Value**
Receive High Working Address **E8_H** **0_H**

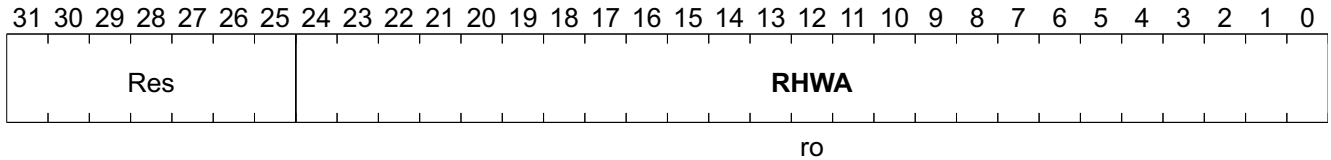

Field	Bits	Type	Description
Res	31:25		Reserved Not Applicable.
RHWA	24:0	ro	The Descriptor WORKING Address of SW_to_CPU (high priority)

Receive Low Working Address

rec_Lwaddr **Offset** **Reset Value**
Receive Low Working Address **EC_H** **0_H**

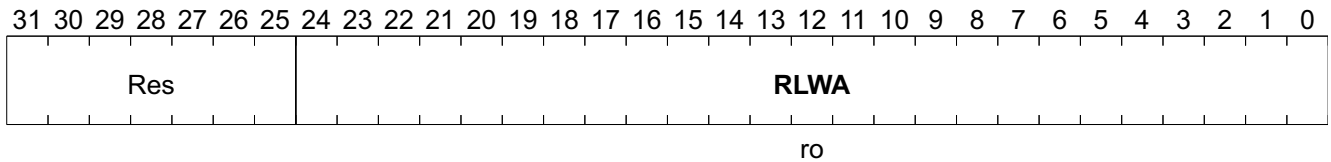

Field	Bits	Type	Description
Res	31:25		Reserved Not Applicable.
RLWA	24:0	ro	The Descriptor WORKING Address of SW_to_CPU (normal priority)

Timer Interrupt

Timer_int Offset Reset Value
 Timer Interrupt F0_H 10000_H

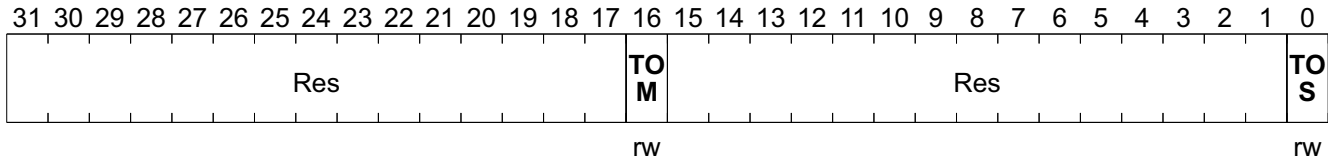

Field	Bits	Type	Description
Res	31:17		Reserved Not Applicable.
TOM	16	rw	Time Out Mask 1 _D Mask the time out interrupt(default) 0 _D Enable the time out interrupt
Res	15:1		Reserved Not Applicable.
TOS	0	rw	Time Out Status Write 1 clear the time out status. Show the time out status on read. The status is down count to zero on Timer register.

Timer

Timer Offset Reset Value
 Timer F4_H FFFF_H

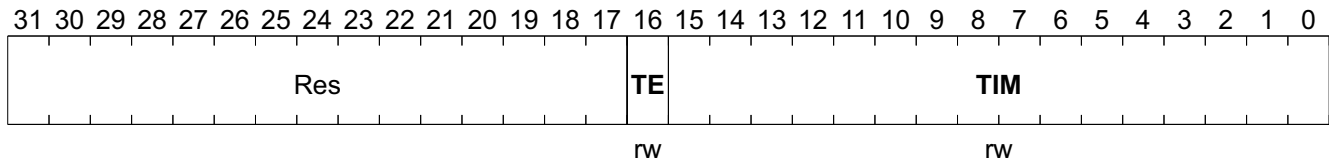

Field	Bits	Type	Description
Res	31:17		Reserved Not Applicable
TE	16	rw	Timer Enable 0 _B Disable the timer count down(default) 1 _B Enable the timer count down
TIM	15:0		Timer Unit 640 ns, auto-reload. Set the time out value on write. Read will return the current timer value. FFFF _H Default value

Reserved 4

Res_4	Offset	Reset Value
Reserved 4	F8 _H	0 _H

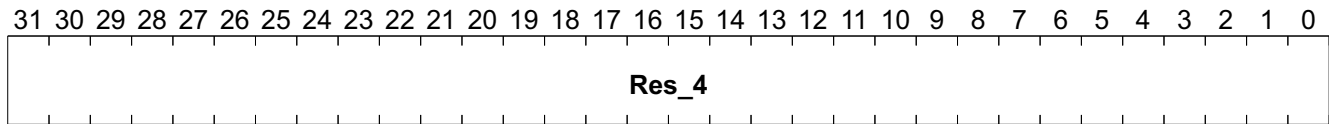

Field	Bits	Type	Description
Res_4	31:0		Reserved Not Applicable.

Reserved 5

Res_5	Offset	Reset Value
Reserved 5	FC _H	0 _H

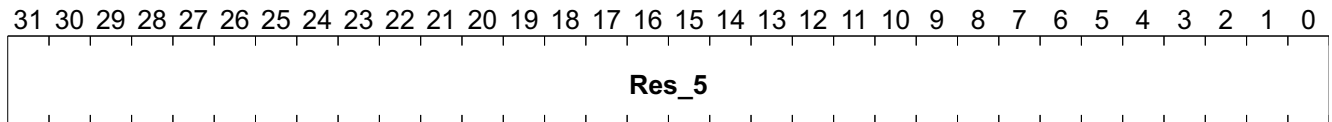

Field	Bits	Type	Description
Res_5	31:0		Reserved Not Applicable.

Port 0 LED

Note: Port0 LED[2:0] pin (164,165,166) configuration register.

port0_LED	Offset	Reset Value
Port 0 LED	100 _H	A59 _H

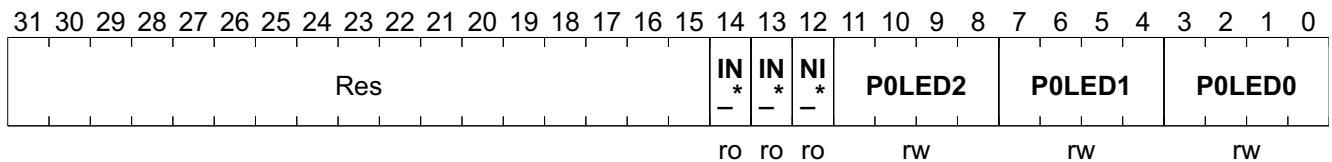

Field	Bits	Type	Description
Res	31:15		Reserved Not Applicable.
IN_P0LED2	14	ro	Input in Port 0 LED2 Input value at pin Port 0 LED2 when it is configured to GPIO_in mode
IN_P0LED1	13	ro	Input in Port 0 LED1 Input value at pin Port 0 LED1 when it is configured to GPIO_in mode
NI_P0LED0	12	ro	Input in Port 0 LED0 Input value at pin Port 0 LED0 when it is configured to GPIO_in mode

Field	Bits	Type	Description
POLED2	11:8	rw	Port 0 LED2 State 0000 _B GPIO_in. 0001 _B GPIO_output_flash. 0010 _B GPIO_output_1 0011 _B GPIO_output_0. 0100 _B Link (steady). 0101 _B Speed (steady) 0110 _B Duplex (steady). 0111 _B Activity (flash). 1000 _B Collision (flash) 1001 _B Link + activity. 1010 _B Default value, duplex/col 1011 _B 10M_link + activity 1100 _B 100M_link + activity. 1101 _B Reserved. 1110 _B Reserved. 1111 _B Reserved.
POLED1	7:4		Port 0 LED1 State Refer to the definition in POLED2 except the default value. 0101 _B Default value, speed
POLED0	3:0		Port 0 LED0 State Refer to the definition in POLED2 except the default value. 1001 _B Default value, Link/activity

Port 1 LED

Note: Port1 LED[2:0] pin (161,162,163) configuration register.

port1_LED	Offset	Reset Value
Port 1 LED	104 _H	A59 _H

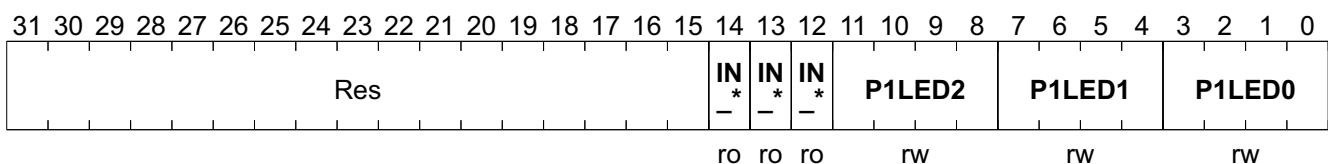

Field	Bits	Type	Description
Res	31:15		Reserved Not Applicable.
IN_P1LED2	14	ro	Input in Port 1 LED2 Input value at pin Port 1 LED2 when it is configured to GPIO_in mode
IN_P1LED1	13	ro	Input in Port 1 LED1 Input value at pin Port 1 LED1 when it is configured to GPIO_in mode
IN_P1LED0	12	ro	Input in Port 1 LED0 Input value at pin Port 1 LED0 when it is configured to GPIO_in mode

Field	Bits	Type	Description
P1LED2	11:8	rw	Port 1 LED2 State Refer to the definition in P0LED2 except the default value. 1010 _B Default value, duplex/col
P1LED1	7:4		Port 1 LED1 State Refer to the definition in P0LED2 except the default value. 0101 _B Default value, speed
P1LED0	3:0		Port 1 LED0 State Refer to the definition in P0LED2 except the default value. 1001 _B Default value, link/activity

Port 2 LED

Note: Port2 LED[2:0] pin (147,158,160) configuration register.

port2_LED	Offset	Reset Value
Port 2 LED	108 _H	A59 _H

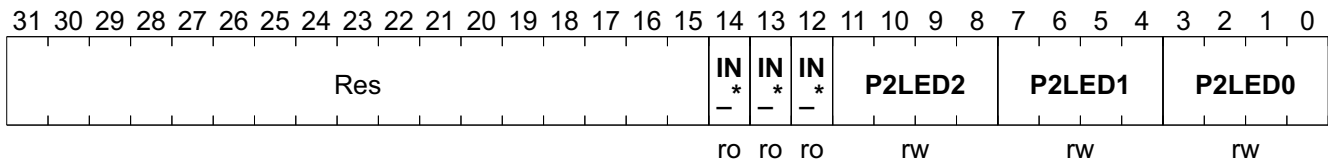

Field	Bits	Type	Description
Res	31:15		Reserved Not Applicable.
IN_P2LED2	14	ro	Input in Port 2 LED2 Input value at pin Port 2 LED2 when it is configured to GPIO_in mode
IN_P2LED1	13	ro	Input in Port 2 LED1 Input value at pin Port 2 LED1 when it is configured to GPIO_in mode
IN_P2LED0	12	ro	Input in Port 2 LED0 Input value at pin Port 2 LED0 when it is configured to GPIO_in mode
P2LED2	11:8	rw	Port 2 LED2 State Refer to the definition in P0LED2 except the default value. 1010 _B Default value, duplex/col
P2LED1	7:4		Port 2 LED1 State Refer to the definition in P0LED2 except the default value. 0101 _B Default value, speed
P2LED0	3:0		Port 2 LED0 State Refer to the definition in P0LED2 except the default value. 1001 _B Default value, link/activity

port3_LED

Note: Port3 LED[2:0] pin (144,145,146) configuration register.

port3_LED	Offset	Reset Value
Port 3 LED	10C_H	A59_H

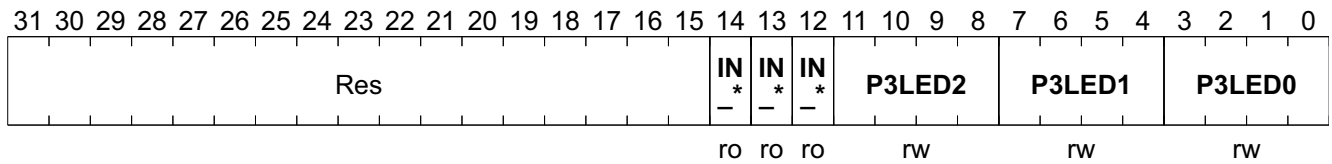

Field	Bits	Type	Description
Res	31:15		Reserved Not Applicable.
IN_P3LED2	14	ro	Input in Port 3 LED2 Input value at pin Port 3 LED2 when it is configured to GPIO_in mode
IN_P3LED1	13	ro	Input in Port 3 LED1 Input value at pin Port 3 LED1 when it is configured to GPIO_in mode
IN_P3LED0	12	ro	Input in Port 3 LED0 Input value at pin Port 3 LED0 when it is configured to GPIO_in mode
P3LED2	11:8	rw	Port 3 LED2 State Refer to the definition in P0LED2 except the default value. 1010 _B Default value, duplex/col
P3LED1	7:4		Port 3 LED1 State Refer to the definition in P0LED2 except the default value. 0101 _B Default value, speed
P3LED0	3:0		Port 3 LED0 State Refer to the definition in P0LED2 except the default value. 1001 _B Default value, link/activity

port4_LED

Note: Port4 LED[2:0] pin (141,142,143) configuration register.

port4_LED	Offset	Reset Value
Port 4 LED	110_H	A59_H

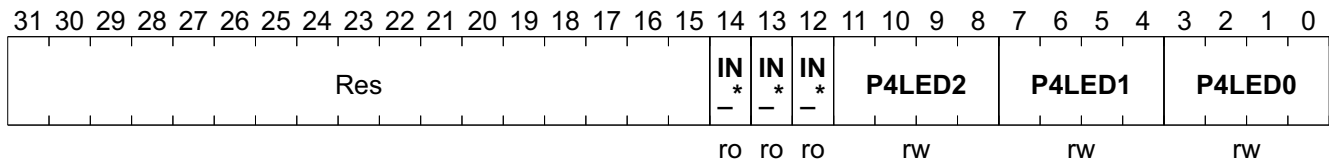

Field	Bits	Type	Description
Res	31:15		Reserved Not Applicable.
IN_P4LED2	14	ro	Input in Port 4 LED2 Input value at pin Port 4 LED2 when it is configured to GPIO_in mode
IN_P4LED1	13	ro	Input in Port 4 LED1 Input value at pin Port 4 LED1 when it is configured to GPIO_in mode
IN_P4LED0	12	ro	Input in Port 4 LED0 Input value at pin Port 4 LED0 when it is configured to GPIO_in mode
P4LED2	11:8	rw	Port 4 LED2 State Refer to the definition in P0LED2 except the default value. 1010 _B Default value, duplex/col
P4LED1	7:4		Port 4 LED1 State Refer to the definition in P0LED2 except the default value. 0101 _B Default value, speed
P4LED0	3:0		Port 4 LED0 State Refer to the definition in P0LED2 except the default value. 1001 _B Default value, link/activity

7 UART

The UART description covers:

- Feature list ([Chapter 7.1](#))
- Functional description ([Chapter 7.2](#))
- External Interface; described in the dedicated chapter of the different interfaces
- Registers ([Chapter 7.3](#))

7.1 Feature List

The UART offers the following features:

- Separate 16 x 8 transmit and 16 x 12 receive FIFO to reduce CPU interrupts
- Programmable baud rate generator
- Standard asynchronous communication bits(start, stop and parity). These are added prior to transmission and removed on reception.
- Fully-programmable serial interface characteristic:
 - Data can be 5, 6, 7 or 8 bits
 - Even, odd, stick or no-parity bit generation and detection
 - 1 or 2 stop bit generation
 - Baud rate generation
- Programmable hardware flow control

7.2 Functional Description

The UART performs:

- Serial-to-parallel conversion on data received from a peripheral device
- Parallel-to-serial conversion on data transmitted to the peripheral device.

The CPU reads and writes data and control/status information through the AMBA APB interface. The transmit and receive paths are buffered with internal FIFO memories enabling up to 16-bytes to be stored independently in both transmit and receive modes.

The UART:

- Includes a programmable baud rate generator that generates a common transmit and receive internal clock from the UART internal reference clock input, UARTCLK = 62.5 MHz
- Offers similar functionality to industry-standard 16C550 UART device
- Supports baud rates up to 460.8 Kbits/s, subject to UARTCLK reference clock frequency.
- UART operations are controlled by the line control register([UARTLCR_H](#))
- The baud rate values are controlled by the [UARTLCR_M](#) and [UARTLCR_L](#) registers
- Can generate individually maskable interrupts from the receive, transmit, modem status and error conditions
- Supports modem status input signals CTS, DCD, DSR and RI
- Supports modem output control lines RTS and DTR
- Uses the nUARTCTS input and nUARTRTS output to automatically control the serial data flow.

[Figure 13](#) shows a block diagram of UART.

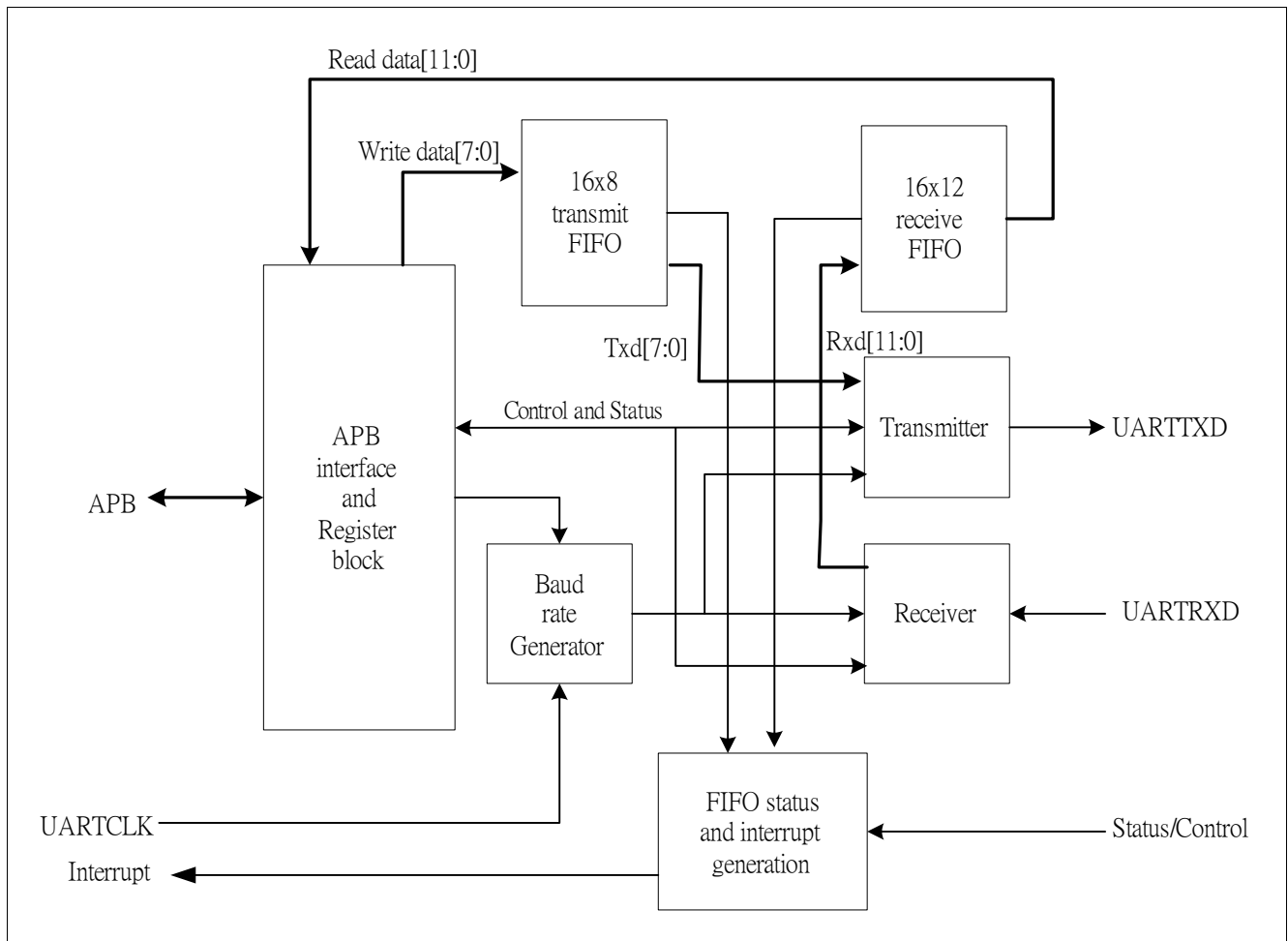

Figure 13 UART block diagram

7.2.1 AMBA APB Interface

The AMBA APB interface generates read and write decodes for accesses to status/control registers and transmit/receive FIFO memories.

7.2.2 Register Block

The register block stores data written to, or to be read across the AMBA APB interface.

7.2.3 Baud Rate Generator

The baud rate generator contains free-running counters that generate the internal x16 clocks, Baud16. Baud16 provides timing information for UART transmit and receive control. Baud16 is a stream of pulses with a width of one UARTCLK clock period and a frequency of 16 times the baud rate.

7.2.4 Transmit FIFO

The transmit FIFO is an 8-bit wide, 16 location deep, FIFO memory buffer. CPU data written across the APB interface is stored in the FIFO until read out by the transmit logic. You can disable the transmit FIFO to act like a one-byte holding register.

7.2.5 Receive FIFO

The receive FIFO is a 12-bit wide, 16 location deep, FIFO memory buffer. Received data and corresponding error bits, are stored in the receive FIFO by the receive logic until read out by the CPU across the APB interface. The receive FIFO can be disabled to act like a one-byte holding register.

7.2.6 Transmit Logic

The transmit logic performs parallel-to-serial conversion on the data read from the transmit FIFO. Control logic outputs the serial bit stream beginning with a start bit, data bits with the LSB first, followed by the parity bit, and then the stop bits according to the programmed configuration in control registers.

7.2.7 Receive Logic

The receive logic performs serial-to-parallel conversion on the received bit stream after a valid start pulse has been detected. Overrun, parity, frame error checking, and line break detection are also performed, and their status accompanies the data that is written to the receive FIFO.

7.3 UART Registers

There are two UART port, one base address is 0x1260 0000 and the other is 0x1280 0000.

Table 36 Registers Address Space

Module	Base Address	End Address	Note
UART	1260 0000 _H	1F _H	–

Table 37 Registers Overview

Register Short Name	Register Long Name	Offset Address	Page Number
UART_D	UART Data	00 _H	172
UARTRRS_ECR	UART Receive Status Register/Error Clear	04 _H	173
UARTLCR_H	UART Line Control Register, High Byte	08 _H	173
UARTLCR_M	UART Line Control Register, Middle Byte	0C _H	174
UARTLCR_L	UART Line control Register, Low Byte	10 _H	175
UARTCR	UART Control	14 _H	175
UARTFR	UART Flag	18 _H	177
UARTIIR_UARTICR	UART Interrupt Identification/Clear	1C _H	178

The register is addressed wordwise.

Table 38 Registers Access Types

Mode	Symbol	Description Hardware (HW)	Description Software (SW)
Basic Access Types			
read/write	rw	Register is used as input for the HW	Register is read and writable by SW
read/write virtual	rvv	Physically, there is no new register in the generated register file. The real readable and writable register resides in the attached hardware.	Register is read and writable by SW (same as rw type register)
read	r	Register is written by HW (register between input and output -> one cycle delay)	Value written by SW is ignored by HW; that is, SW may write any value to this field without affecting HW behavior
read only	ro	Same as r type register	Same as r type register
read virtual	rv	Physically, there is no new register in the generated register file. The real readable register resides in the attached hardware.	Value written by SW is ignored by HW; that is, SW may write any value to this field without affecting HW behavior (same as r type register)
write	w	Register is written by software and affects hardware behavior with every write by software.	Register is writable by SW. When read, the register does not return the value that has been written previously, but some constant value instead.
write virtual	wv	Physically, there is no new register in the generated register file. The real writable register resides in the attached hardware.	Register is writable by SW (same as w type register)
read/write hardware affected	rwh	Register can be modified by hardware and software at the same time. A priority scheme decides, how the value changes with simultaneous writes by hardware and software.	Register can be modified by HW and SW, but the priority SW versus HW has to be specified. SW can read the register.

Table 39 Registers Clock Domains

Clock Short Name	Description
–	–

7.3.1 UART Registers Description

UART Data

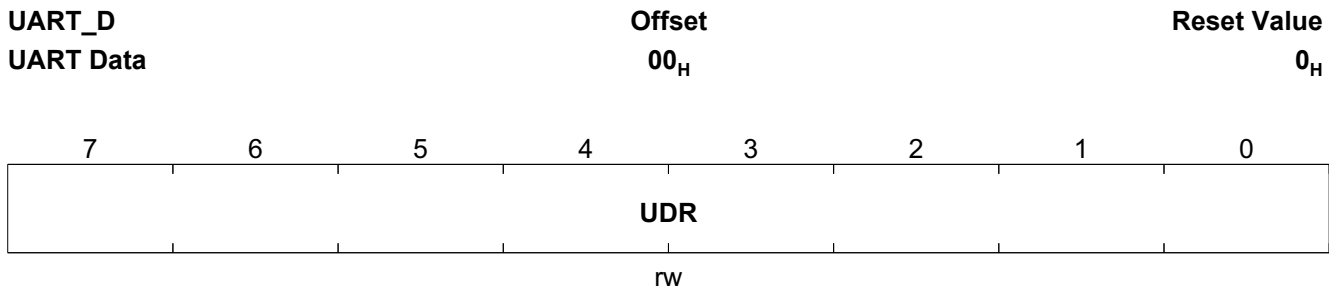

Field	Bits	Type	Description
UDR	7:0	rw	Data Register Receive (read) data character Transmit (write) data character

CONFIDENTIAL

UART

UART Receive Status Register/Error Clear

UARTRRS_ECR **Offset**
 UART Receive Status Register/Error Clear **04_H** **Reset Value**
0_H

7	6	5	4	3	2	1	0
RSR		Res		OE	BE	PE	FE
w		r		r	r	r	r

Field	Bits	Type	Description
RSR	7	w	RSR A write to this register clears the framing, parity, break and overrun errors. The data value is not important.
Res	6:4	r	Reserved Not applicable.
OE	3		Overrun Error This bit is set to 1 if data is received and the FIFO is already full.
BE	2		Break Error This bit is set to 1 if a break condition was detected, indicating that the received data input was held LOW for longer than a full-word transmission time.
PE	1		Parity Error When this bit is set to 1, it indicates that the parity of received data character does not match the parity selected in UARTLCR_H (bit 2)
FE	0		Framing Error When this bit is set to 1, it indicates that the received character did not have a valid stop bit.

UART Line Control Register, High Byte

UARTLCR_H **Offset**
 UART Line Control Register, High Byte **08_H** **Reset Value**
0_H

7	6	5	4	3	2	1	0
Res	WLEN		FEN	STP2	EPS	PEN	BRK
	r/w		r/w	r/w	r/w	r/w	r/w

Field	Bits	Type	Description
Res	7		Reserved Not applicable

Field	Bits	Type	Description
WLEN	6:5	rw	Word Length [1:0] The select bits indicate the number of data bits transmitted or received in a frame as follows:11 = 8 bits10 = 7 bits01 = 6 bits00 = 5 bits 11 _B 8 bits 10 _B 7 bits 01 _B 6 bits 00 _B 5 bits
FEN	4		Enable FIFOs If this bit is set to 1,transmit and receive FIFO buffers are enabled (FIFO mode). When cleared to 0 the FIFOs are disabled (character mode) that is, the FIFOs become 1 byte-deep holding registers.
STP2	3		Two Stop Bits Select If this bit is set to 1, two stop bits are transmitted at the end of the frame. The receive logic does not check for two stop bits being received.
EPS	2		Even Parity Select If this bit is set to 1, even parity generation and checking is performed during transmission and reception, which checks for an even number of 1s in data and parity bits. When cleared to 0 then odd parity is performed which checks for an odd number of 1s.this bit has no effect when parity is disabled by parity enable being cleared to 0.
PEN	1		Parity Enable If this bit is set to 1, parity checking and generation is enabled, else parity is disabled and no parity bit passed to the data frame.
BRK	0		Send Break If this bit is set to 1, a low-level is continually output on the UARTTXD output, after completing transmission of the current character. This bit must be asserted for at least one complete frame transmission time in order to generate a break condition. The transmit FIFO contents remain unaffected during a break condition.For normal use, this bit must be cleared to 0.

UART Line Control Register, Middle Byte

UARTLCR_M	Offset	Reset Value
UART Line Control Register, Middle Byte	0C_H	0_H

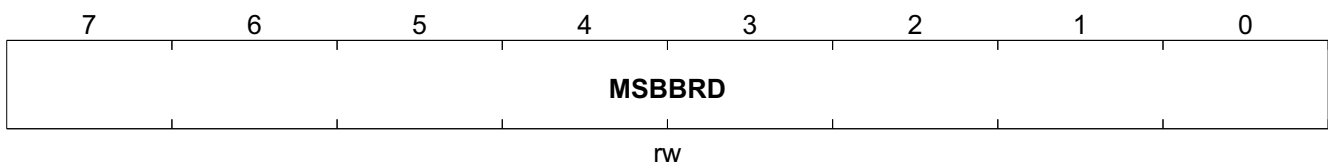

Field	Bits	Type	Description
MSBBD	7:0	rw	Most Significant Byte of Baud Rate Divisor These bits are cleared to 0 on reset.

UART Line Control Register, Low Byte

Note: The baud rate divisor is calculated as follow:

$$\text{Baud rate divisor BAUDDIV} = (\text{FUARTCLK}/(16 \times \text{Baud rate})) - 1$$

Where FUARTCLK is the UART reference clock frequency

The below table show some typical bit rates and their corresponding divisor, given a UART clock frequency of 62.5 MHz. A divisor value of zero is illegal, and so no transmission or reception will occur.

UARTLCR_L **Offset**
UART Line control Register, Low Byte **10_H** **Reset Value**
0_H

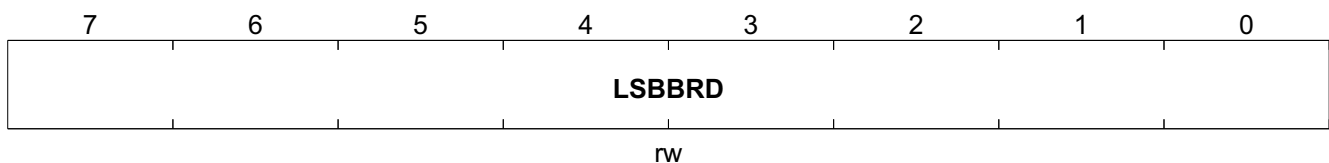

Field	Bits	Type	Description
LSBBRD	7:0	rw	Least Significant Byte of Baud Rate Divisor These bits are cleared to 0 on reset.

UART Control

UARTCR **Offset**
UART Control **14_H** **Reset Value**
0_H

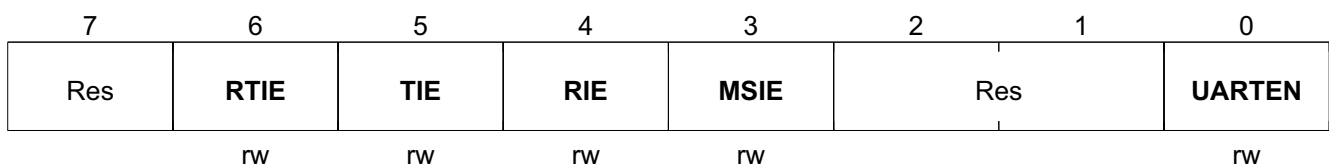

Field	Bits	Type	Description
Res	7		Reserved Not applicable.
RTIE	6	rw	Receive Timeout Interrupt Enable If this bit is set to 1, the receive timeout interrupt is enabled. The receive timeout interrupt is asserted when the receive FIFO is not empty and no further data is received over a 32-bit period. The receive timeout interrupt is cleared when the FIFO becomes empty through reading all the data.

Field	Bits	Type	Description
TIE	5	rw	Transmit Interrupt Enable If this bit is set to 1, the transmit interrupt is enabled. The transmit interrupt changes state when one of the following events occurs: 1.if the FIFOs are enabled and the transmit FIFO is at least half empty, then the transmit interrupt is asserted HIGH. It is cleared by filling the transmit FIFO to more than half full. 2.if the FIFOs are disabled and there is no data preset in the transmitters single location, the transmit FIFO is asserted HIGH. It is cleared by performing a single write to the transmitter FIFO.
RIE	4	rw	Receive Interrupt Enable If this bit is set to 1, the receive interrupt is enabled. The receive interrupt changes state when one of the following events occurs: 1.if the FIFOs are enabled and the receive FIFO is half or more full, then the receive interrupt is asserted HIGH. It is cleared by reading data from the receive FIFO until it becomes less than half full. 2.if the FIFOs are disabled and data is received thereby filling the location, the receive interrupt is asserted HIGH. The receive interrupt is cleared by performing a single read to the receive FIFO.
MSIE	3	rw	Modem Status Interrupt Enable If this bit is set to 1, the modem interrupt is enabled. The modem status interrupt is asserted if any of the modem status lines (CTS,DCD,DSR) change. Modem status changes when one of the following events occurs: (1) 0 → 1 (2) 1 → 0
Res	2:1		Reserved Not applicable
UARTEN	0	rw	UART Enable If this bit set to 1, the UART is enabled.

Field	Bits	Type	Description
TXFE	7	ro	Transmit FIFO Empty The meaning of this bit depends on the state of the FEN bit in the UARTLCR_H register. If the FIFO is disabled, this bit is set when the transmit holding register is empty. If the FIFO is enabled, the TXFE bit is set when the transmit FIFO is empty.
RXFF	6		Receive FIFO Full The meaning of this bit depends on the state of the FEN bit in the UARTLCR_H register. If the FIFO is disabled, this bit is set when the receive holding register is full. If the FIFO is enabled, the RXFF bit is set when the receive FIFO is full.
TXFF	5		Transmit FIFO Full The meaning of this bit depends on the state of the FEN bit in the UARTLCR_H register. If the FIFO is disabled, this bit is set when the transmit holding register is full. If the FIFO is enabled, the TXFF bit is set when the transmit FIFO is full.
RXFE	4		Receive FIFO Empty The meaning of this bit depends on the state of the FEN bit in the UARTLCR_H register. If the FIFO is disabled, this bit is set when the receive holding register is empty. If the FIFO is enabled, the RXFE bit is set when the receive FIFO is empty.
BUSY	3		UART Busy If this bit is set to 1, the UART is busy transmitting data. This bit remains set until the complete byte, including all the stop bits, has been sent from the shift register. This bit is set as soon as the transmit FIFO becomes non-empty.
DCD	2		Data Carrier Detect This bit is the complement of the UART data carrier detect (nUARTDCD) modem status input. That is, the bit is 1 when the modem status input is 0.
DSR	1		Data Set Ready This bit is the complement of the UART data set ready (nUARTDSR) modem status input. That is, the bit is 1 when the modem status input is 0.
CTS	0		Clear to Send This bit is the complement of the UART clear to send (nUARTCTS) modem status input. That is, the bit is 1 when the modem status input is 0.

UART Interrupt Identification/Clear

UARTIIR_UARTICR	Offset	Reset Value
UART Interrupt Identification/Clear	1C _H	0 _H

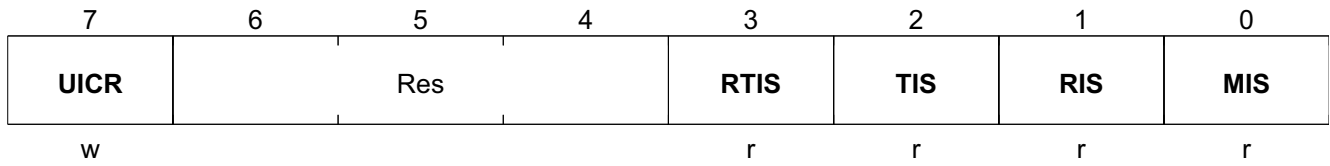

Field	Bits	Type	Description
UICR	7	w	Interrupt Clear A write to this register clears the modem status interrupt, regardless of the value written.
Res	6:4		Reserved Not applicable.
RTIS	3	r	Receive Timeout Interrupt This bit is set to 1 if the UARTRTINTR receive timeout interrupt is asserted.
TIS	2		Transmit Interrupt This bit is set to 1 if the UARTRTINTR transmit interrupt is asserted.
RIS	1		Receive Interrupt This bit is set to 1 if the UARTRTINTR receive interrupt is asserted.
MIS	0		Modem Interrupt Status This bit is set to 1 if the UARTRTINTR modem status interrupt is asserted.

8 USB 1.1 Host Controller

The USB 1.1 host controller provides a USB host solution that can communicate with full speed and low speed devices.

The USB 1.1 host controller covers:

- Feature list ([Chapter 8.1](#))
- Functional description ([Chapter 8.2](#))
- DMA operation [Chapter 8.3](#)
- Registers ([Chapter 8.3.1.1](#) and [Chapter 8.3.1.2](#))

8.1 Feature List

- 32 bit high performance AMBA AHB bus interface
- Little/Big endian byte ordering
- 32-bit Tx/Rx buffer management architecture
- Supports full speed (12Mbps) and low speed (1.5Mbps)
- Supports embedded DPLL to operate from 48 MHz crystal or oscillator
- Supports automatic generation of SOF and CRC5/16
- Supports DMA mode for USB Control, Interrupt and Bulk packets
- Supports descriptor chain architecture for effective packet scheduling
- Support two device ports

8.2 USB 1.1 Function Description

8.2.1 Block Diagram

The following block diagram describes the functional blocks of the Infineon USB 1.1 Host controller.

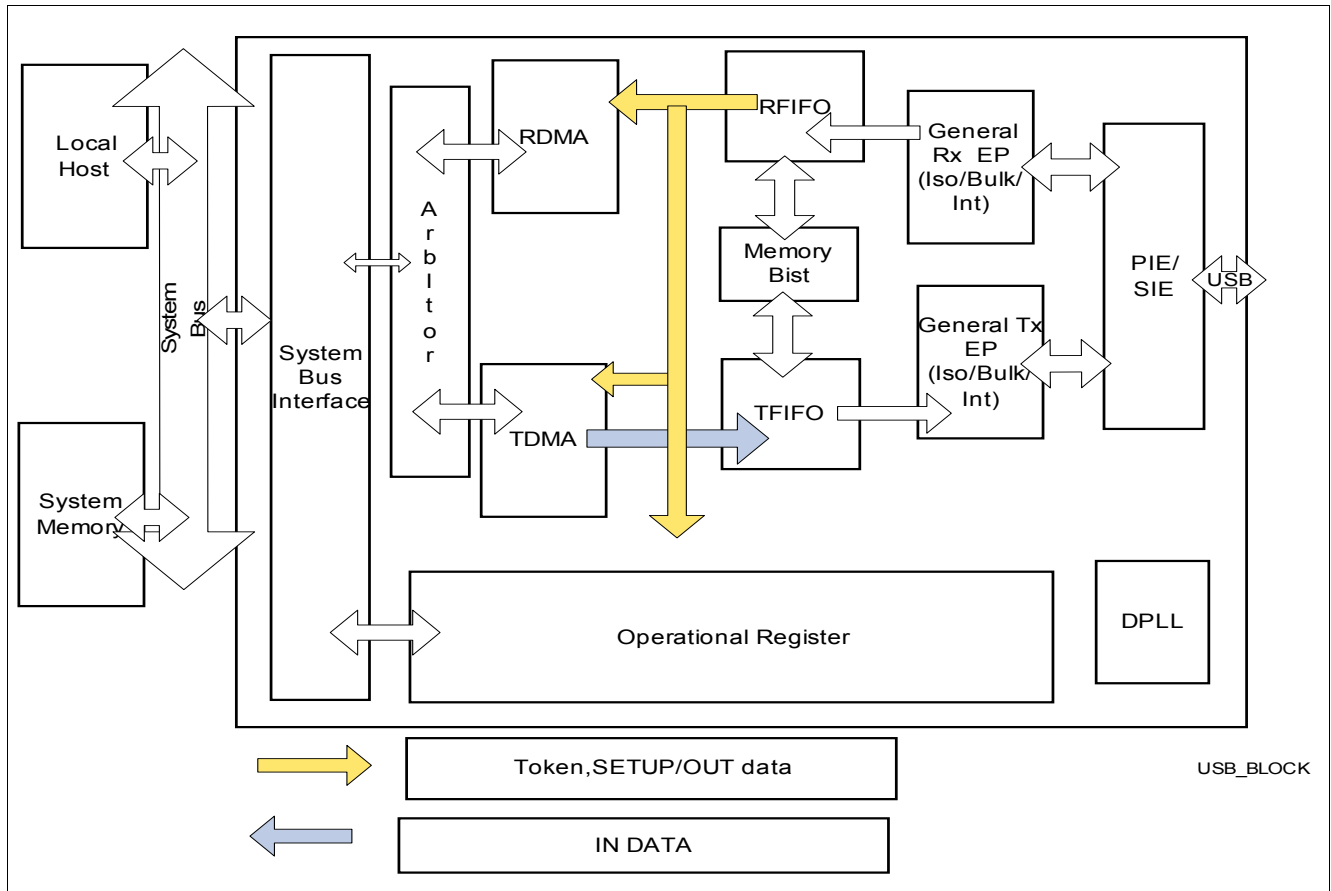

Figure 14 Block Diagram of Infineon USB 1.1 Host Controller

8.2.2 System Bus Interface

This block provides the USB Host controller with the connection to the AHB bus interface. The AHB bus is a 32-bit wide data bus, high-performance pipeline architecture. This block contains the AHB master interface and slave interface. The Host can program the USB Host controller operational register via the AHB slave interface. The DMA units within the USB Host controller will act as bus masters and access the system memory through the AHB master interface.

8.2.3 Operational Register

This block is the CSR (configure and status register) of USB 1.1 Host controller. The local host configures USB 1.1 Host controller via these registers. It includes DMA, endpoint, enable/disable, and interrupt control. The local host gets the status of the USB 1.1 Host controller by reading the registers. It includes the DMA, interrupt and USB bus status. The operational register also provides the interface for the local host to transfer the data for control and interrupt endpoint.

8.2.4 SIE

The SIE handles the link layer protocol of USB. It includes the following items

- Identify the USB SYNC field
- Identify the USB address, endpoint field
- Decode/encode the NRZI
- Generate/check the Bit Stuffing and the CRC
- Convert the USB incoming serial data to 8-bit parallel data

- Convert 8-bit parallel data to USB serial data
- Detect/report/generate USB bus events such as Reset, Suspend and Resume

8.2.5 DPLL

The DPLL block is a digital phase lock loop for extracting clock and data from the USB bus.

8.2.6 Memory BIST

The Memory BIST block is used for testing TFIFO and RFIFO. In this memory BIST, the MARCH C- test algorithm is adopted and the test data bus is 32 bits in width for each FIFO block. During the test period, all FIFO blocks are tested concurrently and the test procedure will be aborted if any fault is detected.

8.3 DMA Operation

3 kinds of Endpoints data transfer (Control, Interrupt and Bulk) are supported in host mode.

8.3.1 Registers Description

Table 40 Registers Address Space

Module	Base Address	End Address	Note
–	7H	7H	–

Table 41 Registers Overview

Register Short Name	Register Long Name	Offset Address	Page Number
Control_Reg	Control Register	H	185
Tail_Trans_Des	Tail Transfer Descriptor	H	186
Head_Trans_Des	Head Transfer Descriptor	H	186
Next_Endp_Trans_Des	Next Endpoint Transfer Descriptor	H	186
Status_Reg	Status Register	H	187
Data_Buf_P	Data Buffer Pointer	H	188
Contr_Buf_L	Controller/Buffer Length	H	190
Next_Tra_Des_P	Next Transfer Descriptor Pointer	H	190

The register is addressed wordwise.

Table 42 Registers Access Types

Mode	Symbol	Description Hardware (HW)	Description Software (SW)
Basic Access Types			
read/write	rw	Register is used as input for the HW	Register is read and writable by SW
read/write virtual	rvv	Physically, there is no new register in the generated register file. The real readable and writable register resides in the attached hardware.	Register is read and writable by SW (same as rw type register)
read	r	Register is written by HW (register between input and output -> one cycle delay)	Value written by SW is ignored by HW; that is, SW may write any value to this field without affecting HW behavior
read only	ro	Same as r type register	Same as r type register
read virtual	rv	Physically, there is no new register in the generated register file. The real readable register resides in the attached hardware.	Value written by SW is ignored by HW; that is, SW may write any value to this field without affecting HW behavior (same as r type register)
write	w	Register is written by software and affects hardware behavior with every write by software.	Register is writable by SW. When read, the register does not return the value that has been written previously, but some constant value instead.
write virtual	wv	Physically, there is no new register in the generated register file. The real writable register resides in the attached hardware.	Register is writable by SW (same as w type register)
read/write hardware affected	rwh	Register can be modified by hardware and software at the same time. A priority scheme decides, how the value changes with simultaneous writes by hardware and software.	Register can be modified by HW and SW, but the priority SW versus HW has to be specified. SW can read the register.

Table 43 Registers Clock Domains

Clock Short Name	Description
-	-

8.3.1.1 Registers

Endpoint Descriptor Format

	31 0
DWORD 0	Control
DWORD 1	Tail Transfer Descriptor
DWORD 2	Head Transfer Descriptor
DWORD 3	Next Endpoint Transfer Descriptor

Control Register

Control_Reg	Offset	Reset Value
Control Register	H	0 _H

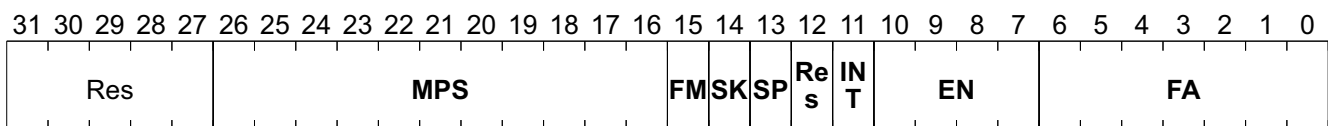

Field	Bits	Type	Description
Res	31:27		Reserved
MPS	26:16		Maximum Packet Size The maximum data that can be transmitted/received in one USB transaction.
FM	15		Format This bit indicates that this packet is for isochronous. 0 _B The data in this descriptor is for general data transfer 1 _B The data in this descriptor is for isochronous transfer
SK	14		Skip When this bit is set, DMA will continue on to the next descriptor in the link list, this is used for isochronous and periodic data transmission/reception.
SP	13		Speed This bit indicates the speed of the data transfer.
Res	12		Reserved
INT	11		Interrupt This bit indicates that this ED is an interrupt endpoint.
EN	10:7		Endpoint Number Endpoint number of the current USB function.
FA	6:0		Function Address Function address of the current USB device.

Tail Transfer Descriptor

Tail_Trans_Des	Offset	Reset Value
Tail Transfer Descriptor	H	0 _H

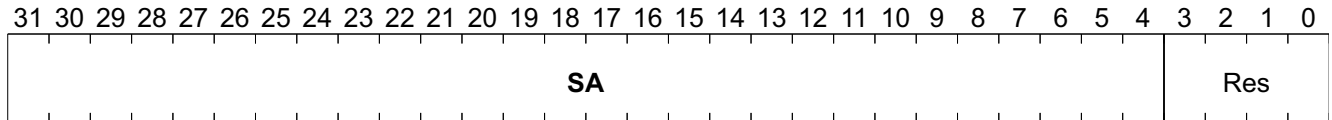

Field	Bits	Type	Description
SA	31:4		Starting Address Starting address of the tail transfer descriptor in host memory space.
Res	3:0		Reserved

Head Transfer Descriptor

Head_Trans_Des	Offset	Reset Value
Head Transfer Descriptor	H	0 _H

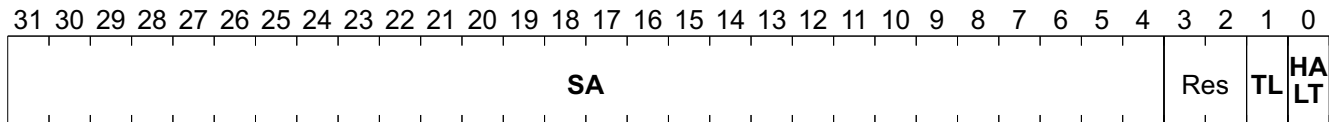

Field	Bits	Type	Description
SA	31:4		Starting Address Starting address of the head transfer descriptor in host memory space.
Res	3:2		Reserved
TL	1		Togglecarry This bit indicates the current toggle value in this transaction.
HALT	0		Halt This bit indicates that this endpoint is halted due to error.

Next Endpoint Transfer Descriptor

Next_Endp_Trans_Des	Offset	Reset Value
Next Endpoint Transfer Descriptor	H	0 _H

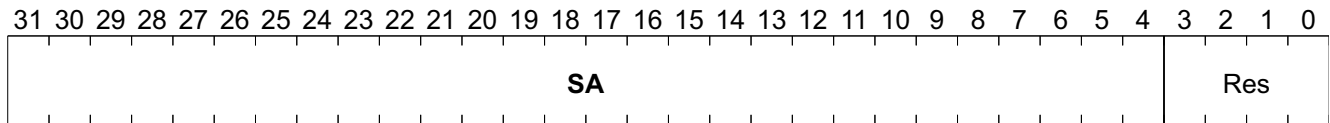

Field	Bits	Type	Description
SA	31:4		Starting Address Starting address of the next endpoint transfer descriptor in host memory space.
Res	3:0		Reserved

8.3.1.2 Registers

Transfer Descriptor Format

	31	0
DWORD 0	Status	
DWORD 1	Data Buffer Pointer	
DWORD 2	Controller/Buffer Length	
DWORD 3	Next Transfer Descriptor Pointer	

Status Register

Status_Reg	Offset	Reset Value
Status Register	H	0 _H

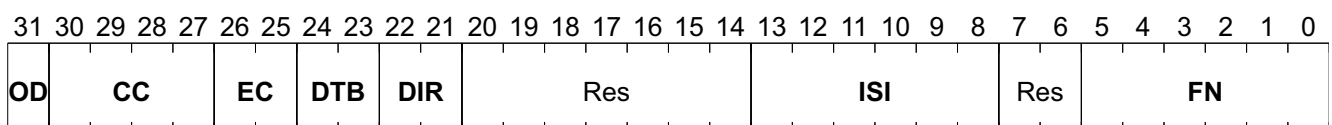

Field	Bits	Type	Description
OD	31		Owner Descriptor Descriptor ownership bit – set to 0 when the host owns the descriptor, set to 1 by the host to tell the USB Host controller it owns the descriptor, the controller will clear this bit when reception has been done.

Field	Bits	Type	Description
CC	30:27		Complete Code The transfer status of each USB transfer. 0000 _B No Error 0001 _B CRC Check Error 0010 _B Bit-Stuffing Error 0011 _B Data Toggle Error 0100 _B STALL 0101 _B Device No Response (Timeout) 0110 _B PID Error (Invalid PID) 0111 _B Unexpected PID 1000 _B Data Overrun (Packet Overrun) 1001 _B Data Underrun (Packet Underrun) 1100 _B Buffer Overrun 1101 _B Buffer Underrun
EC	26:25		Error Count Error count the error that happens at each USB transfer.
DTB	24:23		Data Toggle Bit This field is used for data PID value. When 1, use bit 23 as the toggle bit. 24 _B When 0, use toggle carry bit in ED as the PID 23 _B Toggle value
DIR	22:21		Direction These bits indicate this packet's direction. 00 _B Setup packet 01 _B Out packet 10 _B IN packet 11 _B Res Reserved
Res	20:14		Reserved
ISI	13:8		Interrupt Service Interval This field indicates the frame interval where the interrupt transaction occurs. The frame interval = bit [13:8] + 1
Res	7:6		Reserved
FN	5:0		Frame Number This field indicates the frame number that receive/transmit this data, this field is only valid when configured in Isochronous and interrupt transaction. For Isochronous transaction, it indicates the frame number in which the isochronous transaction should occur. For interrupt transaction, software uses this field to indicate to hardware for the "starting frame number" of the interrupt transaction, hardware will update this field to the "next frame number" after the current transaction is done.

Data Buffer Pointer

Data_Buf_P	Offset	Reset Value
Data Buffer Pointer	H	0 _H

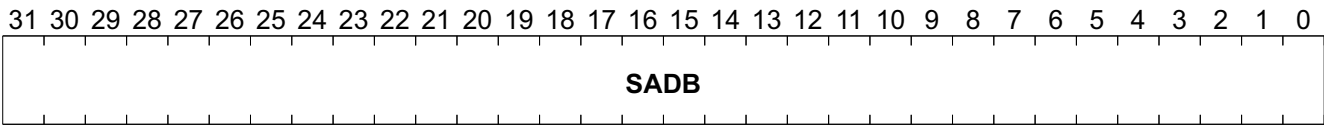

Field	Bits	Type	Description
SADB	31:0		<p>Starting Address of the Data Buffer</p> <p>This field indicates the starting address of the data buffer. Data buffer may be aligned on any byte. When an OUT or SETUP packet has been transmitted, this field will be updated as the next start address of the data buffer.</p>

Controller/Buffer Length

Contr_Buf_L **Offset** **Reset Value**
Controller/Buffer Length H **0_H**

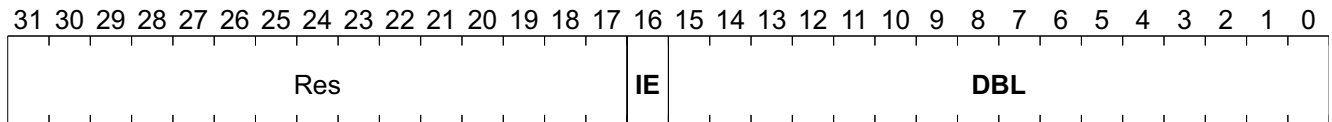

Field	Bits	Type	Description
Res	31:17		Reserved
IE	16		Interrupt Enable This field indicates whether the interrupt will be asserted when this descriptor is completed.
DBL	15:0		Length of Data Buffer This field indicates the length of the current data buffer.

Next Transfer Descriptor Pointer

Next_Tra_Des_P **Offset** **Reset Value**
Next Transfer Descriptor Pointer H **0_H**

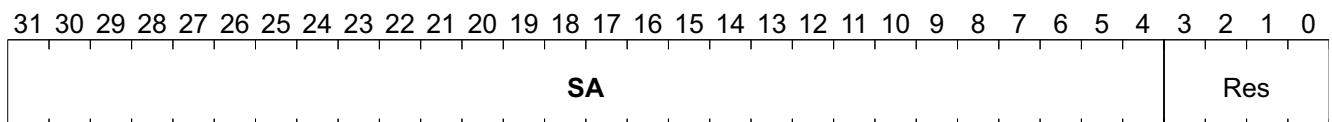

Field	Bits	Type	Description
SA	31:4		Starting Address Starting address of the next descriptor in host memory space.
Res	3:0		Reserved

8.3.2 DMA Operation

To provide a high-performance and effective way for software packet scheduling, the DMA is able to handle both transmit and receive packets in a single descriptor chain. In the endpoint and transfer descriptors, the software can specify the descriptor format (Isochronous or none-Isochronous), direction, speed, and data toggle bit.

If there is any isochronous or periodic data that needs to be transmitted/received, this descriptor needs to link at the beginning of the link list to guarantee the bus bandwidth. After these descriptors, the control or bulk descriptor is linked.

DMA starts to access the first descriptor in the link list and transmit/receive the data through the USB bus. Since there might be several USB packets segmented in one descriptor. After one USB packet is transmitted, DMA will

update the **transmit status, data length, start address of the data buffer**, and **length of data buffer** for further access, and advance to the next descriptor.

When the DMA finishes its transmit/receive of a descriptor, it depends on the setting of the **interrupt enable** to generate HC_INT to indicate this descriptor is ready for the software driver process.

If all the descriptors have been accessed once, and the frame is not yet over, then the DMA will try to access the general descriptor again in order to get a high performance.

If a USB zero length packet is received, then the received data length will be zero, and this buffer is retired due to short packet received.

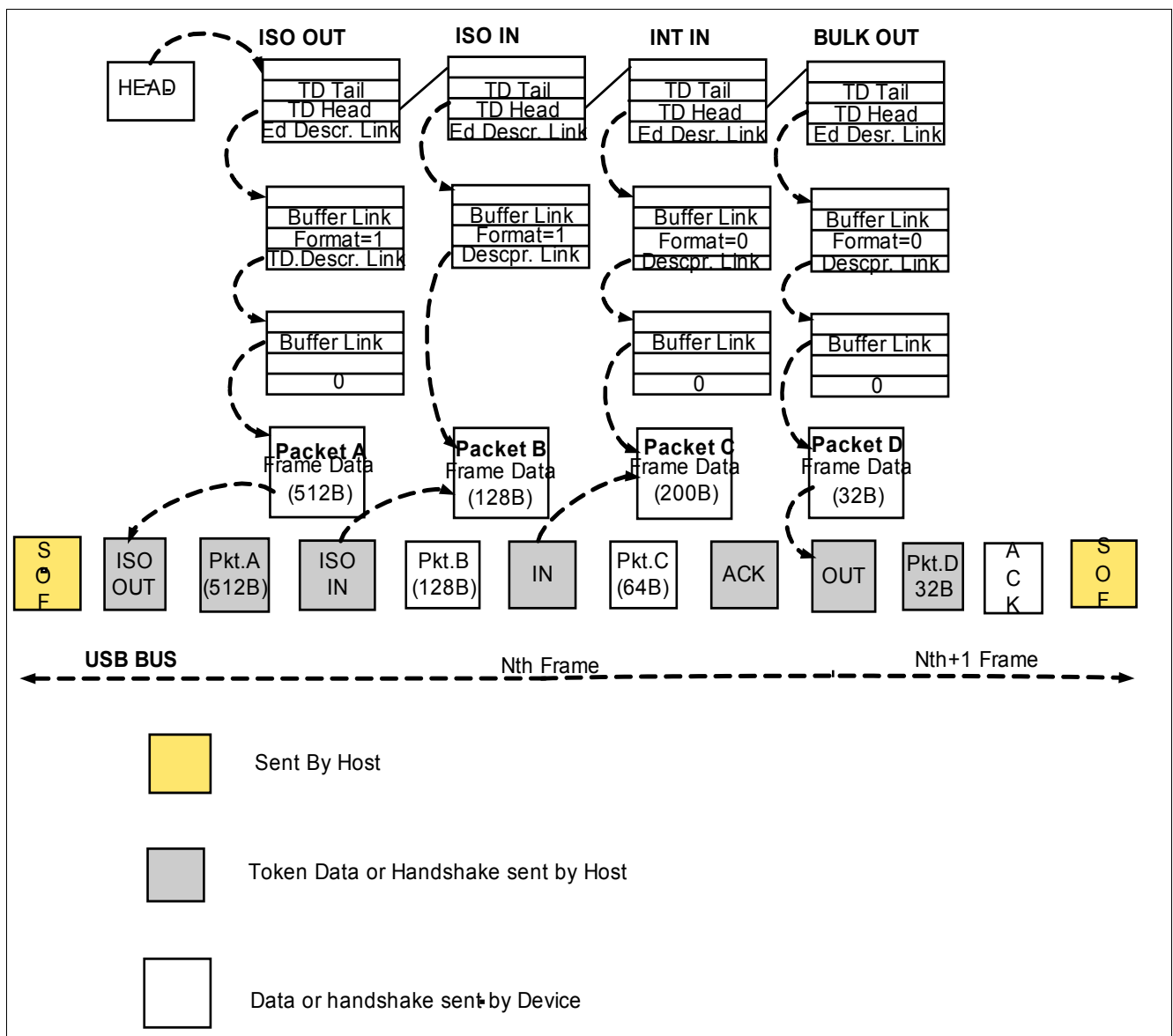

Figure 15 DMA Operation in Host Mode

For Interrupt IN/OUT transactions, each ED just contains one valid TD. Since the Interrupt transaction is periodic, two parameters are defined in TD by software to guide hardware for doing Interrupt transfer, they are Frame Number and Interrupt service period. The Frame Number is used by the software to indicate the frame number of which the first Interrupt transaction occurs, of this TD. The Interrupt service period indicates the frame interval between the current Interrupt transaction and the next one, Frame_Interval is calculated by the following formula:

$$\text{Frame_Interval} = (\text{Interrupt service period} + 1)$$

The transfer of interrupt transaction is activated just when the current frame number matches the Frame Number of the TD, after the current transaction is served, the next frame number will be updated to TD descriptor by hardware, then the hardware waits for the next matched frame number to serve the Interrupt transaction, and so on. The next Frame Number is calculated by (current_Frame_Number) + Frame_Interval. The following diagram describes how Frame_Number and Interrupt_service_period work.

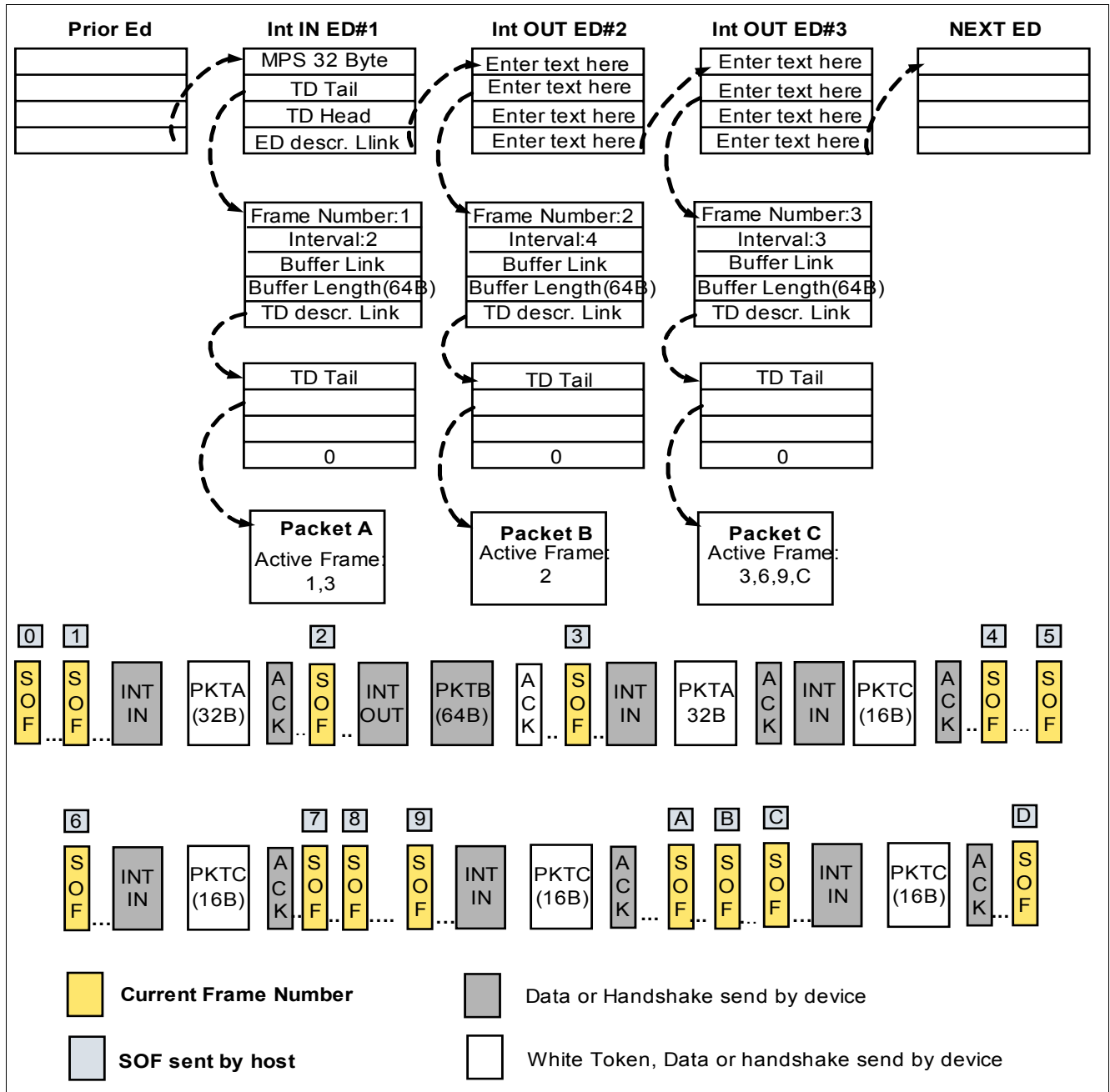

Figure 16 Interrupt IN/OUT Transactions

8.4 USB Control Status Register Map

Table 44 Registers Address Space

Module	Base Address	End Address	Note
USB Control Status	1120 0000 _H	1120 0080 _H	–

Table 45 Registers Overview

Register Short Name	Register Long Name	Offset Address	Page Number
GC	General Control	00 _H	195
INT_S	Interrupt Status	04 _H	196
INT_E	Interrupt Enable	08 _H	197
Res_6	Reserved 6	0C _H	198
H_Gen_Cntl	Host General Control	10 _H	198
Res_7	Reserved 7	14 _H	198
SOF_FI	SOF Frame Interval	18 _H	200
SOF_FN	SOF Frame Number	1C _H	201
RR0	Reserved 0	20 _H	202
RR_1	Reserved Register 1	21 _H	202
RR_2	Reserved Register 2	22 _H	202
RR_76	Reserved Register 76	6C _H	202
Low_STh	Low Speed Threshold	70 _H	203
RH_D	RH Descriptor	74 _H	203
PX_St	Port X Status	78 _H	206
HDHS_Ad	Host Descriptor Head Starting Address	80 _H	210

The register is addressed wordwise.

Table 46 Registers Access Types

Mode	Symbol	Description Hardware (HW)	Description Software (SW)
Basic Access Types			
read/write	rw	Register is used as input for the HW	Register is read and writable by SW
read/write virtual	rvv	Physically, there is no new register in the generated register file. The real readable and writable register resides in the attached hardware.	Register is read and writable by SW (same as rw type register)
read	r	Register is written by HW (register between input and output -> one cycle delay)	Value written by SW is ignored by HW; that is, SW may write any value to this field without affecting HW behavior
read only	ro	Same as r type register	Same as r type register
read virtual	rv	Physically, there is no new register in the generated register file. The real readable register resides in the attached hardware.	Value written by SW is ignored by HW; that is, SW may write any value to this field without affecting HW behavior (same as r type register)
write	w	Register is written by software and affects hardware behavior with every write by software.	Register is writable by SW. When read, the register does not return the value that has been written previously, but some constant value instead.
write virtual	wv	Physically, there is no new register in the generated register file. The real writable register resides in the attached hardware.	Register is writable by SW (same as w type register)
read/write hardware affected	rwh	Register can be modified by hardware and software at the same time. A priority scheme decides, how the value changes with simultaneous writes by hardware and software.	Register can be modified by HW and SW, but the priority SW versus HW has to be specified. SW can read the register.

Table 47 Registers Clock Domains

Clock Short Name	Description
-	-

8.4.1 USB Control Status Registers Description

Host processors can only access USB 1.1 host/device controller registers with double word (32 bits) reads or writes on double word boundaries.

General Control

GC **Offset** **Reset Value**
General Control **00_H** **0_H**

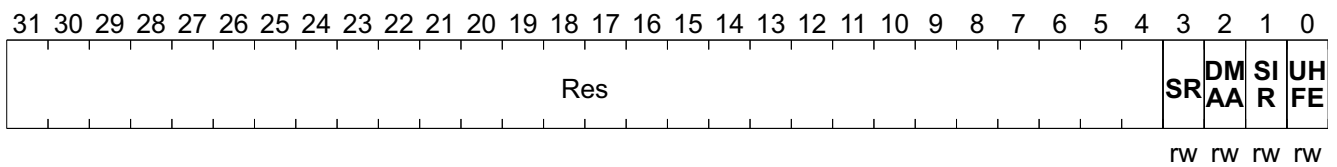

Field	Bits	Type	Description
Res	31:4		Reserved Not Applicable.
SR	3	rw	Software Reset, Both Modes Setting this bit resets the device controller to its initial state. This bit is auto-cleared after reset. Writing a 0 to this bit takes no effect.
DMAA	2		DMA Arbitration Control, Both Modes 0 _B Receive = Transmit (1:1) 1 _B Receive > Transmit
SIR	1		Software Interrupt Request, Both Modes When this bit is set to 1, the controller's interrupt pin becomes active. Reading this bit always returns zero. When SW_INT in interrupt is clear, this bit is clear as well.
UHFE	0		USB Host Function Enable, Both Modes This bit enables the USB host functions, when 1'b1, the controller acts as USB host.

Interrupt Status

INT_S	Offset	Reset Value
Interrupt Status	04_H	0_H

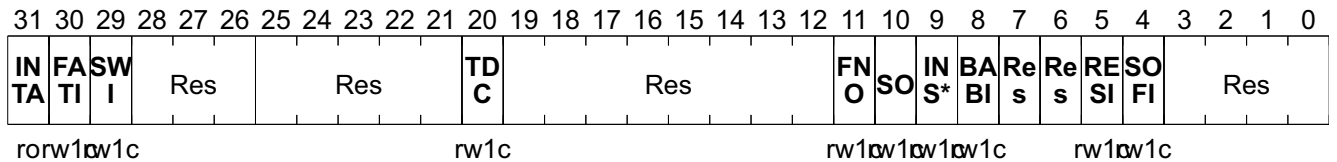

Field	Bits	Type	Description
INTA	31	ro	Interrupt Active When this bit is set, it indicates that at least one unmasked interrupt status is set.
FATI	30	rw1c	Fatal Interrupt, Device Mode Reserved. Host mode: 1 _B Fatal system bus error occurs
SWI	29		Software Interrupt, Both Modes 1 _B Software Interrupt. This bit is set when software set one to SW_INT_REQ 00 _H , and is cleared after software writes one to this bit.
Res	28:26		Reserved Not Applicable
Res	25:21		Reserved Not Applicable
TDC	20	rw1c	A TD is Completed
Res	19:12		Reserved Not Applicable
FNO	11	rw1c	Frame Number Overflow This bit is set when the MSB of the frame number changes.
SO	10		Scheduling Overrun This bit is set when USB schedules for current frame overruns.
INSMI	9		Root Hub Status Change 1 _B Detected device insertion or remove. This bit will only be set for the device or hub, which is attached to host directly.
BABI	8		Babble Detected, Host Mode 1 _B Detected babble
Res	7		Reserved Not Applicable
Res	6		Reserved Not Applicable

Field	Bits	Type	Description
RESI	5	rw1c	Resume Detected 1 _B USB resume event is detected. Controller sets this bit to one when resume signal is detected on USB bus.
SOFI	4		SOF Transmitted/Received, Host Mode 1 _B Issue a SOF token. The frame number value is stored in 1C _H Frame Number
Res	3:0		Reserved Not Applicable

Interrupt Enable

INT_E	Offset	Reset Value
Interrupt Enable	08_H	0_H

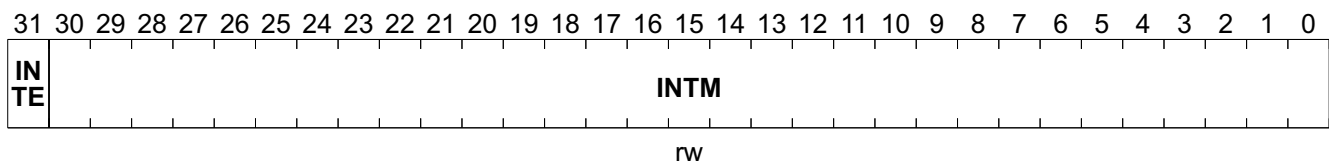

Field	Bits	Type	Description
INTE	31		Interrupt Enable 0 _B Disable the controller to assert interrupt 1 _B Enable the controller to assert interrupt
INTM	30:0	rw	Interrupt Mask Bits are set to allow the corresponding interrupts (bit 21:0 in Interrupt Status register) to generate an interrupt request. And cleared to prevent the interrupt from happening.

Reserved 6

Res_6	Offset	Reset Value
Reserved 6	0C _H	0 _H

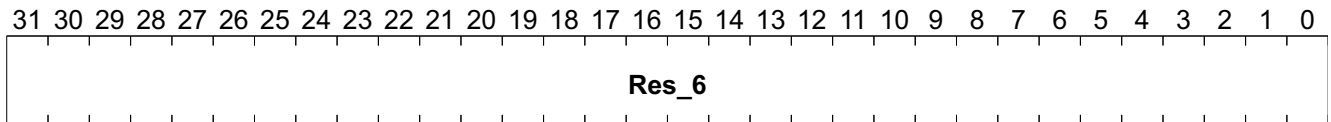

Field	Bits	Type	Description
Res_6	31:0		Reserved Not Applicable.

Host General Control

H_Gen_Cntl	Offset	Reset Value
Host General Control	10 _H	0 _H

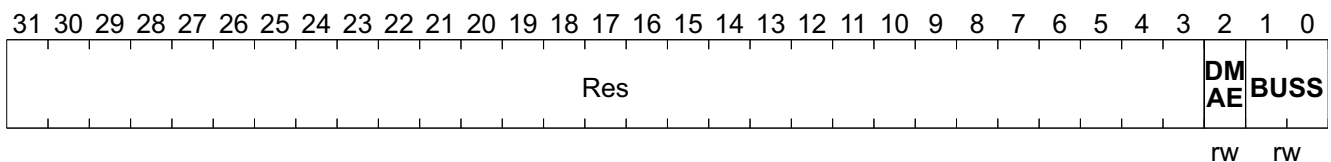

Field	Bits	Type	Description
Res	31:3		Reserved Not Applicable.
DMAE	2	rw	USB Host DMA Enable This bit enables the host controller DMA functionality. When enabled the DMA will start to fetch the descriptor for processing.
BUSS	1:0		USB Bus State A transition to USB operational state will cause the SOF generation to start 1 ms later. 00 _B USB reset state. 01 _B USB resume state 10 _B USB operational state 11 _B USB suspend state.

Reserved 7

Res_7	Offset	Reset Value
Reserved 7	14 _H	0 _H

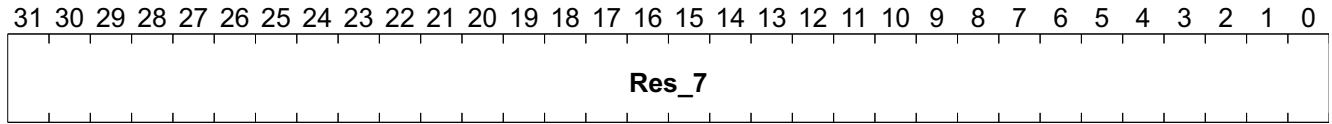

Field	Bits	Type	Description
Res_7	31:0		Reserved Not Applicable

SOF Frame Interval

SOF_FI	Offset	Reset Value
SOF Frame Interval	18_H	2EDF_H

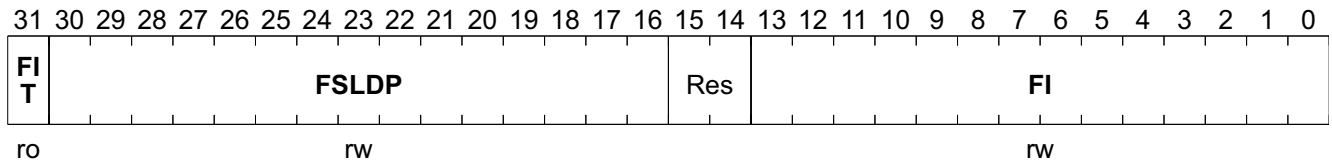

Field	Bits	Type	Description
FI T	31	ro	Frame Interval Toggle Software toggles this bit whenever it loads a new value to FM_INTERVAL.
FSLDP	30:16	rw	FS Largest Data Packet This field specifies a value which is loaded into the Largest Data Packet Counter at the beginning of each frame. The counter value represents the largest amount of data in bits which can be sent or received by the HC in a single transaction at any given time without causing scheduling overrun. The field value is calculated by the software.
Res	15:14		Reserved Not Applicable
FI	13:0	rw	Frame Interval This specifies the interval between two consecutive SOFs in bit times. The nominal value is set to be 11,999. Software should store the current value of this field before resetting HC.

CONFIDENTIAL
USB 1.1 Host Controller
SOF Frame Number

SOF_FN	Offset	Reset Value
SOF Frame Number	1C_H	0_H

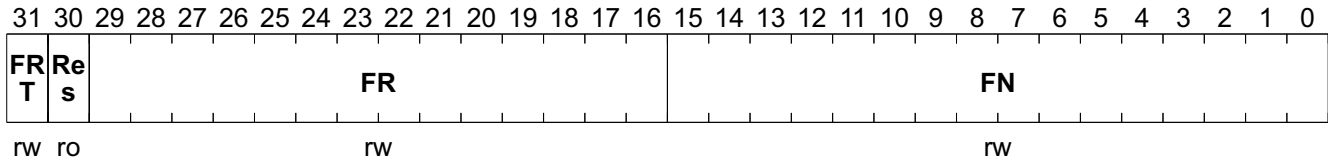

Field	Bits	Type	Description
FRT	31	rw	Frame Remaining Toggle This bit is loaded from the FM_INTERVAL_TOG field of FM_INTERVAL whenever FM_REMAIN remaining reaches 0. This bit is used by software for the synchronization between FM_INTERVAL and FM_REMAIN.
Res	30	ro	Reserved
FR	29:16	rw	Frame Remaining This counter is decremented at each bit time. When it reaches zero, it is reset by loading the frame Interval value specified in FM_INTERVAL at the next bit time boundary. When entering the USBOPERATIONAL state, HC re-loads the content with the FM_INTERVAL of and uses the updated value from the next SOF.
FN	15:0		Frame Number This field is a 16-bit counter. It provides a timing reference among events happening in the Host Controller and the Host Controller Driver. The Host Controller Driver may use the 16-bit value specified in this register and generate a 32-bit frame number without requiring frequent access to the register.

Reserved 0

RR0	Offset	Reset Value
Reserved 0	20 _H	0 _H

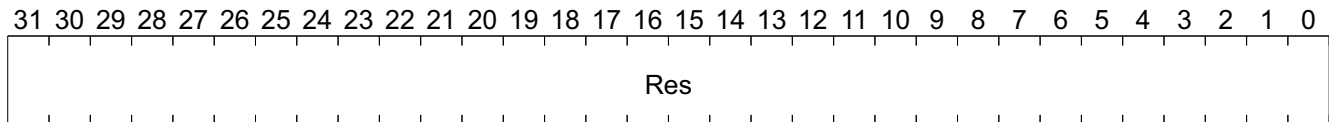

Field	Bits	Type	Description
Res	31:0		Reserved Not Applicable.

Similar Registers

Other Reserved Registers have the same structure and characteristics as **Reserved 0**; the names and offset addresses are listed in [Table 48](#).

Table 48 Reserved Registers

Register Short Name	Register Long Name	Offset Address	Page Number
RR_1	Reserved Register 1	21 _H	
RR_2	Reserved Register 2	22 _H	
... _H	
RR_76	Reserved Register 76	6C _H	

Low Speed Threshold

Low_STh	Offset	Reset Value
Low Speed Threshold	70_H	628_H

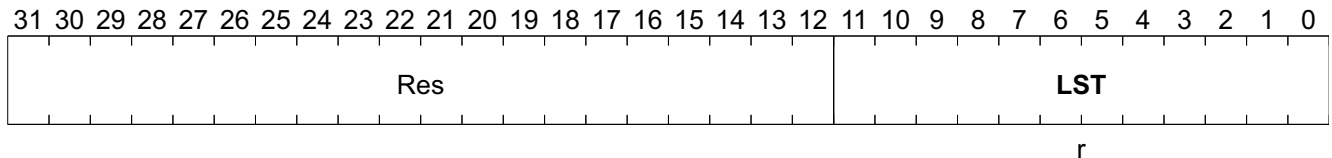

Field	Bits	Type	Description
LST	11:0	r	Low Speed Threshold This field contains a value which is compared to the FM_REMAIN field prior to initiating a Low Speed transaction. The transaction is started only if FM_REMAIN > = this field. The value is calculated by HCD with the consideration of transmission and setup overhead.
Res	31:12		Reserved

RH Descriptor

RH_D	Offset	Reset Value
RH Descriptor	74_H	1_H

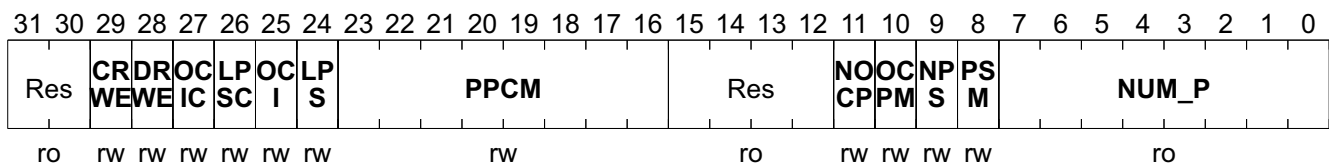

Field	Bits	Type	Description
Res	31:30	ro	Reserved Not Applicable.

Field	Bits	Type	Description
CRWE	29	rw	Clear Remote Wakeup Enable 0 _B Has no effect. 1 _B Clears Device Remove Wakeup Enable
DRWE	28		Device Remote Wakeup Enable This bit enables a Connect Status Change bit as a resume event, causing a USBSUSPEND to USBRESUME state transition and setting the Resume Detected interrupt. 0 _B Connect Status Change is not a remote wakeup event 1 _B Connect Status Change is a remote wakeup event
OCIC	27		Over Current Indication Change This bit is set by hardware when a change has occurred to the OCI field of this register. The HCD clears this bit by writing a 1. Writing a 0 has no effect.
LPSC	26		Local Power Switch Change (read) This bit is always read as 0. Set Global Power (write) In global power mode (PSM =0), This bit is written to 1 to turn on power to all ports (clearPPS). In per-port power mode, it sets PPS only on ports whose PPCM bit is not set. Writing a 0 has no effect.
OCI	25		Over Current Indication This bit reports overcurrent conditions when the global reporting is implemented. When set, an overcurrent condition exists. When cleared, all power operations are normal. If per-port overcurrent protection is implemented this bit is always 0
LPS	24		Local Power Switch (read) This bit is always read as 0. Clear Global Power (write) In global power mode (PSM =0), This bit is written to 1 to turn off power to all ports (clearPPS). In per-port power mode, it clears PPS only on ports whose PPCM bit is not set. Writing a 0 has no effect.
PPCM	23:16		Port Power Control Each bit indicates if a port is affected by a global power control command when PSM is set. When set, the port's power state is only affected by per-port power control (Set/ClearPortPower). When cleared, the port is controlled by the global power (switchSet/ClearGlobalPower). If the device is configured to global switching mode (PSM =0), this field is not valid. Bit 0: Reserved Bit 1: Ganged-power mask on Port #1 Bit 2: Ganged-power mask on Port #2 ... Bit7: Ganged-power mask on Port #7
Res	15:12		ro

Field	Bits	Type	Description
NOCP	11	rw	<p>No Over Current Protect</p> <p>This bit describes how the overcurrent status for the Root Hub ports are reported. When this bit is cleared, the OCPM field specifies global or per-port reporting.</p> <p>0_B Over-current status is reported collectively for all downstream ports 1_B No overcurrent protection supported</p>
OCPM	10		<p>Over Current Protect Mode</p> <p>This bit describes how the overcurrent status for the Root Hub ports are reported. At reset, this fields should reflect the same mode as PSM. This field is valid only if the NOCP field is cleared.</p> <p>0_B Over-current status is reported collectively for all downstream ports 1_B Over-current status is reported on a per-port basis</p>
NPS	9		<p>No Power Switch</p> <p>These bits are used to specify whether power switching is supported or port are always powered. It is implementation-specific. When this bit is cleared, the PSM specifies global or per-port switching.</p> <p>0_B Ports are power switched 1_B Ports are always powered on when the HC is powered on</p>
PSM	8		<p>Power Switch Mode</p> <p>This bit is used to specify how the power switching of the Root Hub ports is controlled. It is implementation-specific. This field is only valid if the NPS field is cleared.</p> <p>0_B All ports are powered at the same time 1_B Each port is powered individually. This mode allows portpower to be controlled by either the global switch or per-port switching. If the PPCM bit is set per-port switching. If the PPCM bit is set, the port responds only to port power commands (Set/ClearPortPower). If the port mask is cleared, then the port is controlled only by the global power switch (Set/ClearGlobalPower).</p>
NUM_P	7:0	ro	Number Port

Port X Status

PX_St	Offset	Reset Value
Port X Status	78_H	0_H

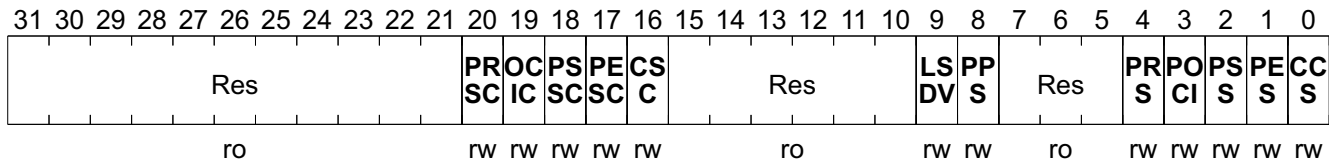

Field	Bits	Type	Description
Res	31:21	ro	Reserved Not Applicable.
PRSC	20	rw	Port Reset Status Change This bit is set at the end of the 10 ms port reset signal. The HCD writes a 1 to clear this bit. Writing a 0 has no effect. 0 _B Port reset is not complete 1 _B Port reset is complete
OCIC	19		Over Current Indicator Change This bit is valid only if overcurrent conditions are reported on a per-port basis. This bit is set when Root Hub changes the POCI bit. The HCD writes a 1 to clear this bit. Writing a 0 has no effect. 0 _B No change in POCI 1 _B OCI has changed
PSSC	18		Port Suspend Status Change This bit is set when the full resume sequence has been completed. This sequence includes the 20 s resume pulse, LS EOP, and 3 ms re synchronization delay. The HCD writes a 1 to clear this bit. Writing a 0 has no effect. This bit is also cleared when RSC is set. 0 _B Resume is not completed 1 _B Resume completed
PESC	17		Port Enable Status Change This bit is set when hardware events cause the PES bit to be cleared. Changes from HCD writes do not set this bit. The HCD writes a 1 to clear this bit. Writing a 0 has no effect. 0 _B No change in PES 1 _B Change in PES

Field	Bits	Type	Description
CSC	16	rw	<p>Connect Status Change</p> <p>This bit is set whenever a connect or disconnect event occurs. The HCD writes a 1 to clear this bit. Writing a 0 has no effect. If CCS is cleared when a SPR, SPE, or SPS write occurs, this bit is set to force the driver to re-evaluate the connection status since these writes should not occur if the port is disconnected.</p> <p><i>Note: This bit is set only after a Root Hub reset to inform the system that the device is attached.</i></p> <p>0_B No change in CCS 1_B Change in CCS</p>
Res	15:10	ro	<p>Reserved</p> <p>Not Applicable.</p>
LSDV	9	rw	<p>Low Speed Device Attached (read)</p> <p>This bit indicates the speed of the device attached to this port. When set, a Low Speed device is attached to this port. When clear, a Full Speed device is attached to this port. This field is valid only when the CurrentConnectStatus is set.</p> <p>0_B Full speed device attached 1_B Low speed device attached</p> <p>Clear Port Power (write)</p> <p>The HCD clears the PortPowerStatus bit by writing a 1 to this bit. Writing a 0 has no effect.</p>
PPS	8		<p>Port Power Status (read)</p> <p>This bit reflects the port's power status, regardless of the type of power switching implemented. This bit is cleared if an overcurrent condition is detected. HCD sets this bit by writing SPP or SGP. HCD clears this bit by writing CPP or CGP. Which power control switches are enabled is determined by PSM and PPCM[NDP]. In global switching mode (PSM =0), only Set/ClearGlobalPower controls this bit. In per-port power switching (PSM =1), if the PPCM[NDP] bit for the port is set, only Set/ClearPortPower commands are enabled. If the mask is not set, only Set/ClearGlobalPower commands are enabled. When port power is disabled, CCS, PES, PSS, and PRS should be reset.</p> <p>0_B Port power is off 1_B Port power is on</p> <p>Set Port Power (write)</p> <p>The HCD writes a 1 to set the PPS bit. Writing a 0 has no effect.</p> <p><i>Note: This bit is always reads 1 if power switching is not supported.</i></p>
Res	7:5	ro	<p>Reserved</p> <p>Not Applicable.</p>

Field	Bits	Type	Description
PRS	4	rw	<p>Port Reset Status (read) When this bit is set by a write to SPR, port reset signaling is asserted. When reset is completed, this bit is cleared when PRSC is set. This bit cannot be set if CCS is cleared. 0_B Port reset signal is not active 1_B Port reset signal is active</p> <p>Set Port Reset (write) The HCD sets the port reset signaling by writing a 1 to this bit. Writing a 0 has no effect. If CCS is cleared, this write does not set PRS, but instead sets CSC. This informs the driver that it attempted to reset a disconnected port.</p>

Field	Bits	Type	Description
POCI	3	rw	<p>Port Over Current Indicator (read)</p> <p>This bit is only valid when the Root Hub is configured in such a way that overcurrent conditions are reported on a per-port basis. If per-port overcurrent reporting is not supported, this bit is set to 0. If cleared, all power operations are normal for this port. If set, an overcurrent condition exists on this port. This bit always reflects the overcurrent input signal.</p> <p>0_B No overcurrent condition 1_B Overcurrent condition detected</p> <p>Clear Suspend Status (write)</p> <p>The HCD writes a 1 to initiate a resume. Writing a 0 has no effect. A resume is initiated only if PSS is set.</p>
PSS	2		<p>Port Suspend Status (read)</p> <p>This bit indicates the port is suspended or in the resume sequence. It is set by a SSS write and cleared when PSSC is set at the end of the resume interval. This bit cannot be set if CCS is cleared. This bit is also cleared when PRSC is set at the end of the port reset or when the HC is placed in the USBRESUME state. If an upstream resume is in progress, it should propagate to the HC.</p> <p>0_B Port is not suspended 1_B Port is suspended</p> <p>Set Port Suspend (write)</p> <p>The HCD sets the PSS bit by writing a 1 to this bit. Writing a 0 has no effect. If CCS is cleared, this write does not set PSS; instead it sets CSC. This informs the driver that it attempted to suspend a disconnected port.</p>
PES	1		<p>Port Enable Status (read)</p> <p>This bit indicates whether the port is enabled or disabled. The Root Hub may clear this bit when an overcurrent condition, disconnect event, switched-off power, or operational bus error such as babble is detected. This change also causes PESC to be set. HCD sets this bit by writing SPE and clears it by writing CPE. This bit cannot be set when CCS is cleared. This bit is also set, if not already, at the completion of a port reset when RSC is set or port suspend when SSC is set.</p> <p><i>Note: This informs the driver that it attempted to enable a disconnected port.</i></p> <p>0_B Port is disabled 1_B Port is enabled</p> <p>Set Port Enable (write)</p> <p>The HCD sets PortEnableStatus by writing a 1. Writing a 0 has no effect. If CCS is cleared, this write does not set PES, but instead sets CSC. This informs the driver that it attempted to enable a disconnected port.</p>
CCS	0		<p>Current Connect Status (read)</p> <p>This bit reflects the current state of the downstream port.</p> <p>0_B No device connected 1_B Device connected</p> <p>Clear Port Enable (write)</p> <p>The HCD writes a 1 to this bit to clear the PES. Writing a 0 has no effect. The CCS is not affected by any write.</p> <p><i>Note: This bit is always read 1 when the attached device is nonremovable</i></p>

Host Descriptor Head Starting Address

HDHS_Ad	Offset	Reset Value
Host Descriptor Head Starting Address	80 _H	0 _H

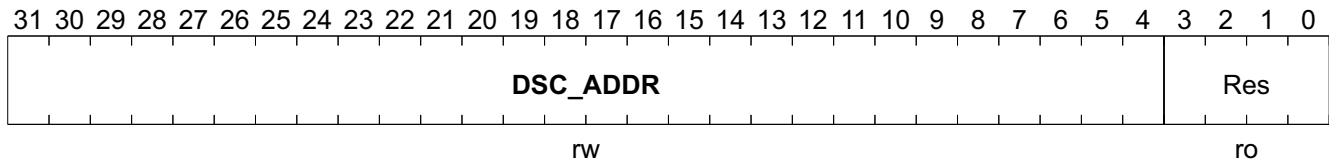

Field	Bits	Type	Description
DSC_ADDR	31:4	rw	Descriptor Chain Address This field indicates the starting address of the host mode descriptor chain. DMA read the descriptor from this location when it is first enabled.
Res	3:0	ro	Reserved

9 Electrical Characteristics

9.1 Absolute Maximum Ratings

Table 49 Absolute Maximum Ratings

Parameter	Symbol	Values			Unit	Note / Test Condition
		Min.	Typ.	Max.		
Supply Voltage	V_{CC}	-0.5	–	1.9	V	–
Input Voltage	V_I	-0.5	–	$V_{CC} + 0.3$	V	–
Output Voltage	V_O	-0.5	–	$V_{CC} + 0.3$	V	–
Storage Temperature	T_S	-65	–	150	°C	–
Ambient Temperature	T_A	-0	–	70	°C	–
ESD Protection	V_{ESD}	-0	–	2000	V	–

Attention: Stresses above the max. values listed here may cause permanent damage to the device. Exposure to absolute maximum rating conditions for extended periods may affect device reliability. Maximum ratings are absolute ratings; exceeding only one of these values may cause irreversible damage to the integrated circuit.

9.2 DC Characteristics

Table 50 DC Characteristics

Parameter	Symbol	Values			Unit	Note / Test Condition
		Min.	Typ.	Max.		
Supply Voltage	V_{CC}	1.7	1.8	1.9	V	–
I/O Supply Voltage	V_{IO_CC}	3.0	3.3	3.6	V	–
Power Supply Current	I_{CC}	–	–	–	mA	$V_{CC} = 1.8\text{ V}$
I/ O Power Supply Current	I_{IO_CC}	–	–	–	mA	$V_{CC} = 3.3\text{ V}$
Input Low Voltage	V_{IL}	-0.5	–	0.8	V	–
Input High Voltage	V_{IH}	2.0	–	3.8	V	–
Input Low Leakage Current	I_{ILL}	-10	–	10	μA	$V_{IN} = 0.8\text{ V}$
Input High Leakage Current	I_{IHL}	-10	–	10	μA	$V_{IN} = 2.0\text{ V}$
Output Low Voltage	V_{OL}	–	–	0.4	V	$I_{OUT} = 2\sim 8\text{ mA}$
Output High Voltage	V_{OH}	2.4	–	–	V	$I_{OUT} = 2\sim 8\text{ mA}$
Input Pin Capacitance	C_{IP}	5	–	8	pF	–
Pin Inductance	L_{PI}	TBD	–	–	nH	–

9.3 AC Timing

9.3.1 SDRAM Interface

(Unit: ns, Min: best case, Max: worst case)

Table 51 SDRAM Interface Timing

Parameter	Symbol	Values			Unit	Note / Test Condition
		Min.	Typ.	Max.		
Clock cycle time	t_{CK}	–	11.4	–	ns	–
Command/address setup delay time in precharge stage	t_{PS}	1.5	–	–	ns	–
Command/address hold delay time in precharge stage	t_{PH}	1	–	–	ns	–
Command/address setup delay time in active stage	t_{AS}	1.5	–	–	ns	–
Command/address hold delay time in active stage	t_{AH}	1	–	–	ns	–
Command/address setup delay time in write stage	t_{WS}	1.5	–	–	ns	–
Command/address hold delay time in write stage	t_{WH}	1	–	–	ns	–
Command/address setup delay time in read stage	t_{RS}	1.5	–	–	ns	–
Command/address hold delay time in read stage	t_{RH}	1	–	–	ns	–

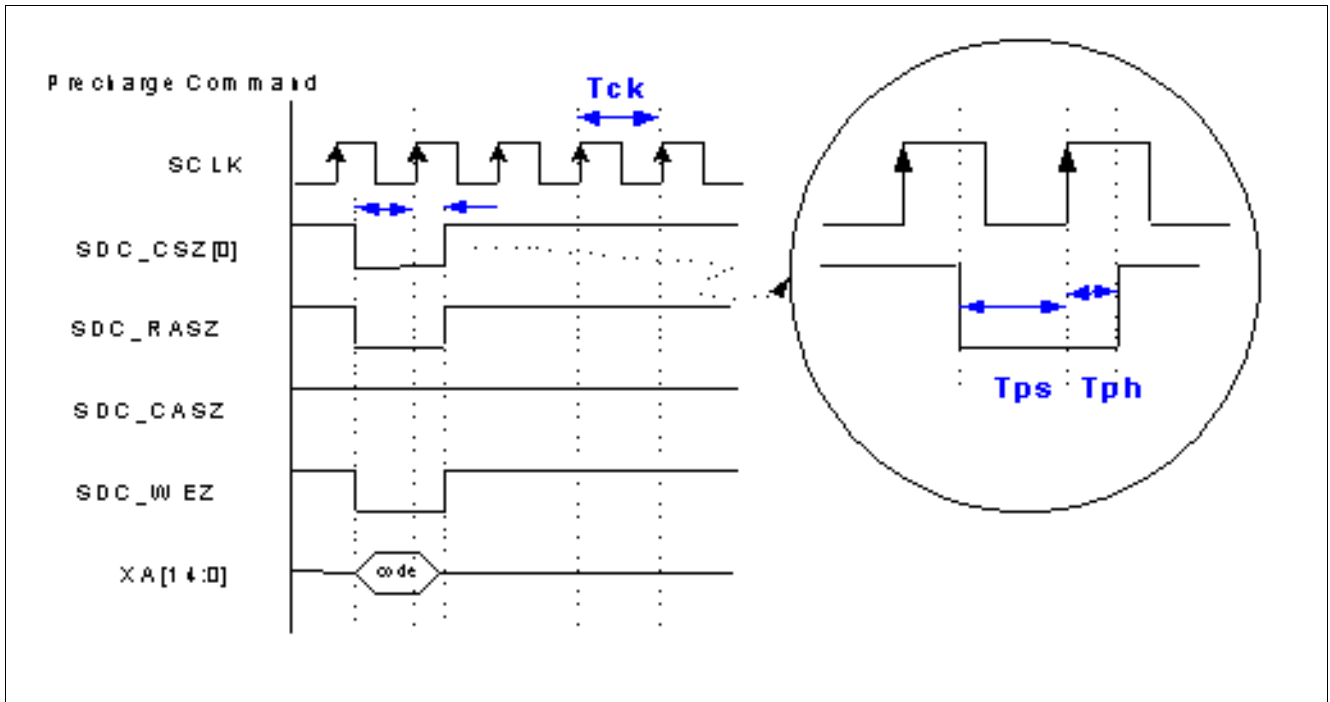

Figure 17 Precharge Command

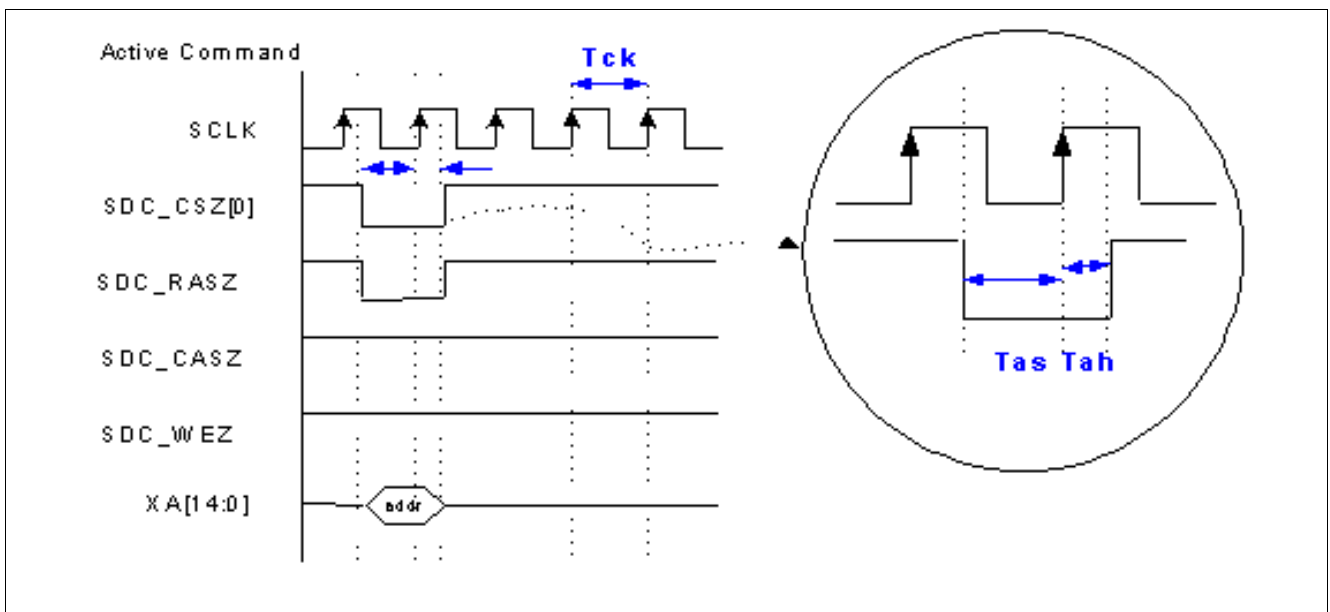

Figure 18 Active Command

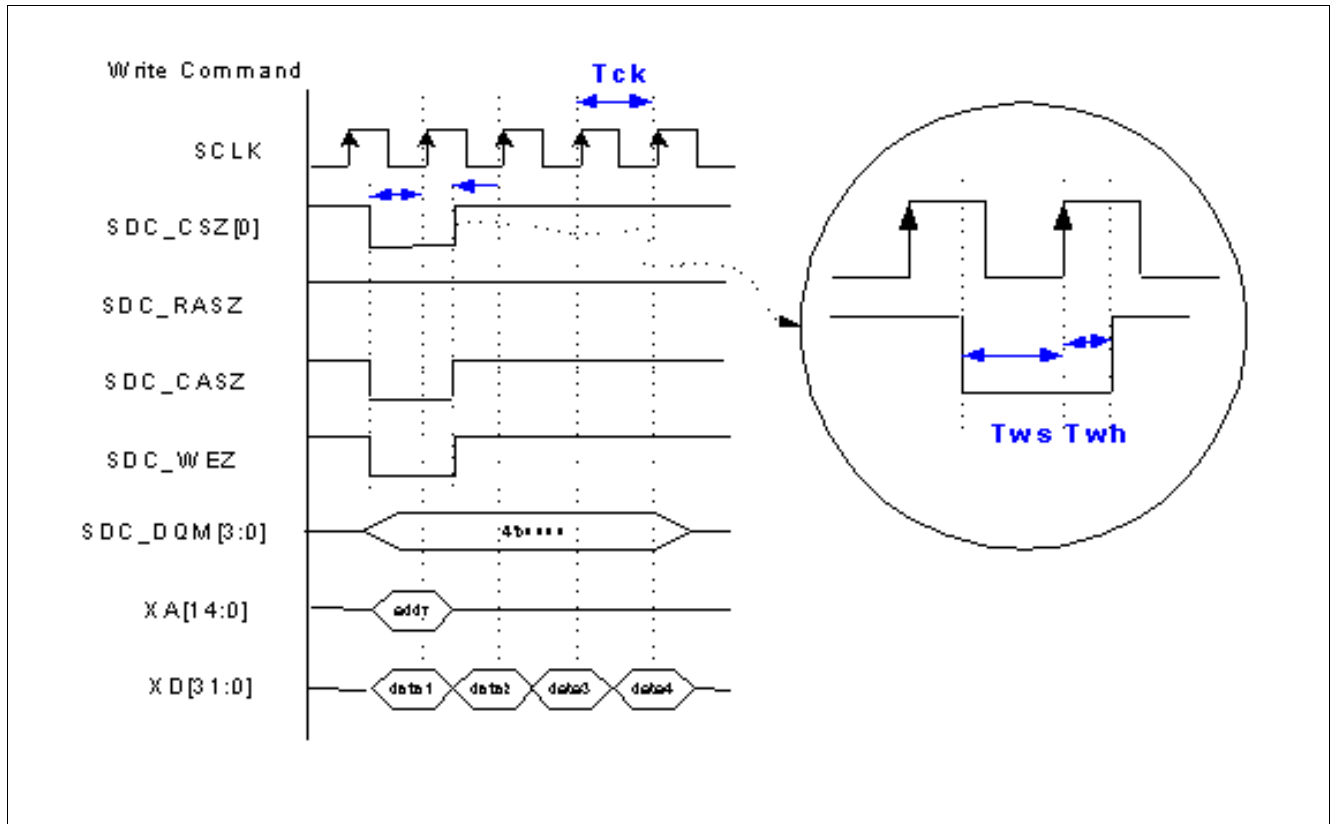

Figure 19 Write Command

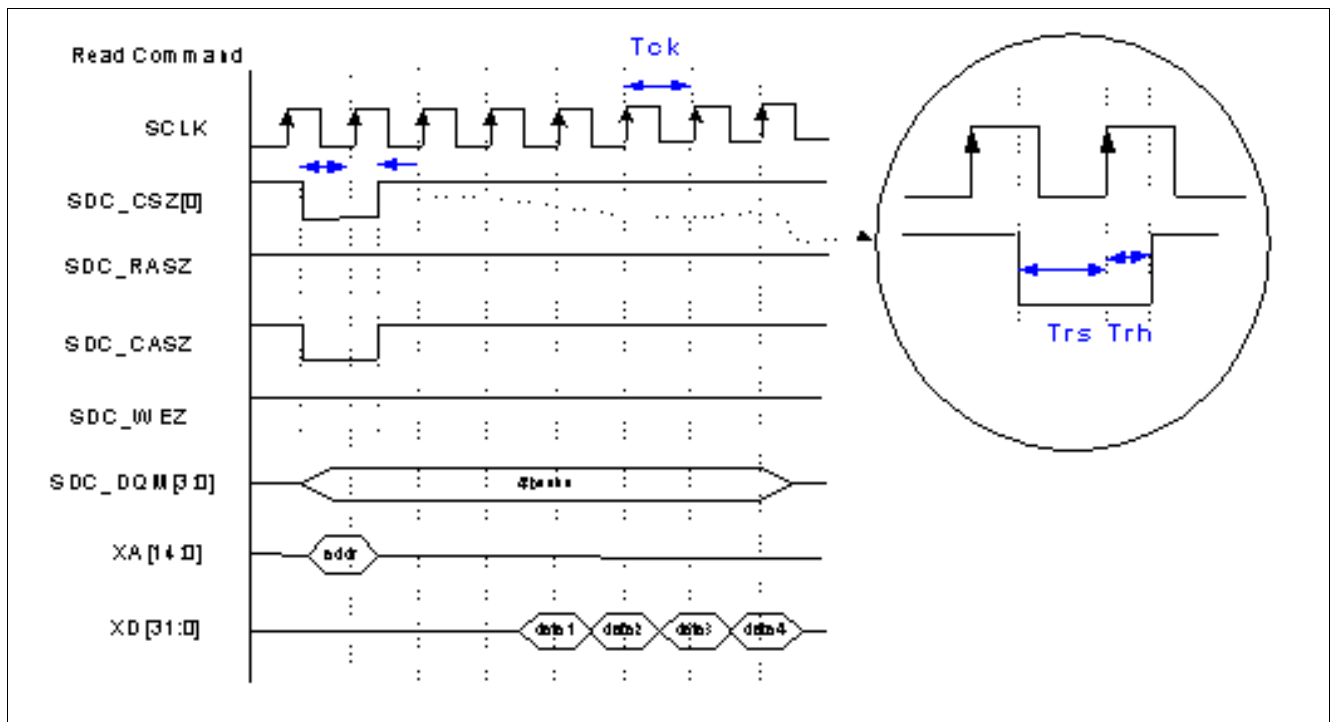

Figure 20 Read Command

9.3.2 Memory Bus Read Timing

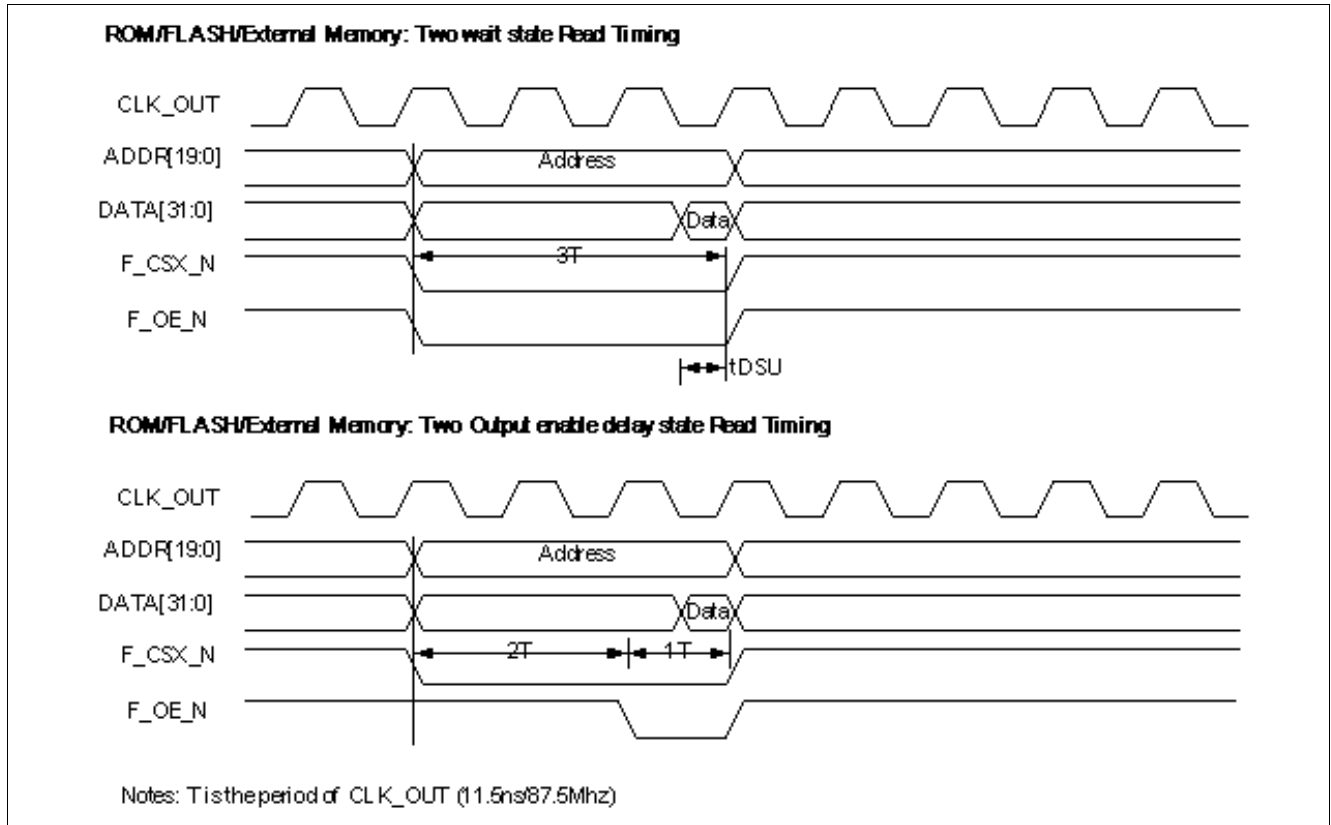

Figure 21 Memory Bus Read Timing

Note: T is the period of CLK_OUT (11.5 ns/87.5 MHz)

Table 52 Memory Bus Read Timing

Parameter	Symbol	Values			Unit	Note / Test Condition
		Min.	Typ.	Max.		
Data to CLK_OUT rising setup time	t_{RDSU}	TBD	–	–		–
Data to CLK_OUT rising hold time	t_{RDH}	TBD	–	–		–
Address/F_CSX_N pulse width	t_{AC}	–	(n+1)T	–		–
Address/F_CSX_N to F_OE_N setup	t_{AOE}	–	nT	–		–

9.3.3 Memory Bus Write Timing

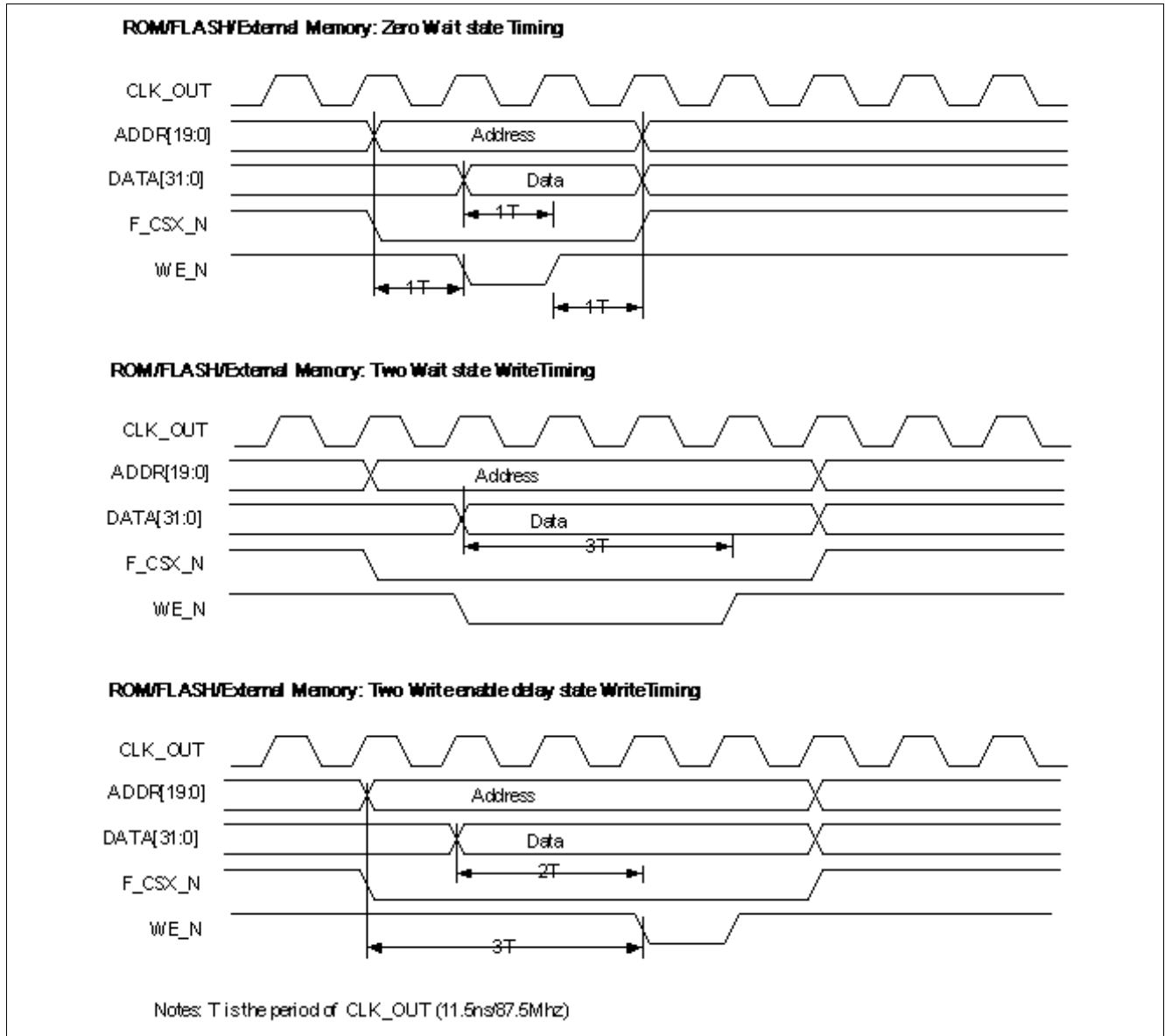

Figure 22 Memory Bus Write Timing

Note: T is the period of CLK_OUT (11.5 ns/87.5 MHz)

Table 53 Memory Bus Write Timing

Parameter	Symbol	Values			Unit	Note / Test Condition
		Min.	Typ.	Max.		
Address/CS to WE_N falling setup time	t_{ASU}	–	(n+1)T	–		–
Data to WE_N rising setup time	t_{WDSU}	–	(n+1)T	–		–
Data to WE_N rising hold time	t_{WDH}	–	1T	–		–
WE_N pulse width	t_{WEP}	–	(n+1)T	–		–

10 Package Outlines

10.1 Plastic Quad Flat Package (P-FQFP) 208-pin

Dimensions in mm.

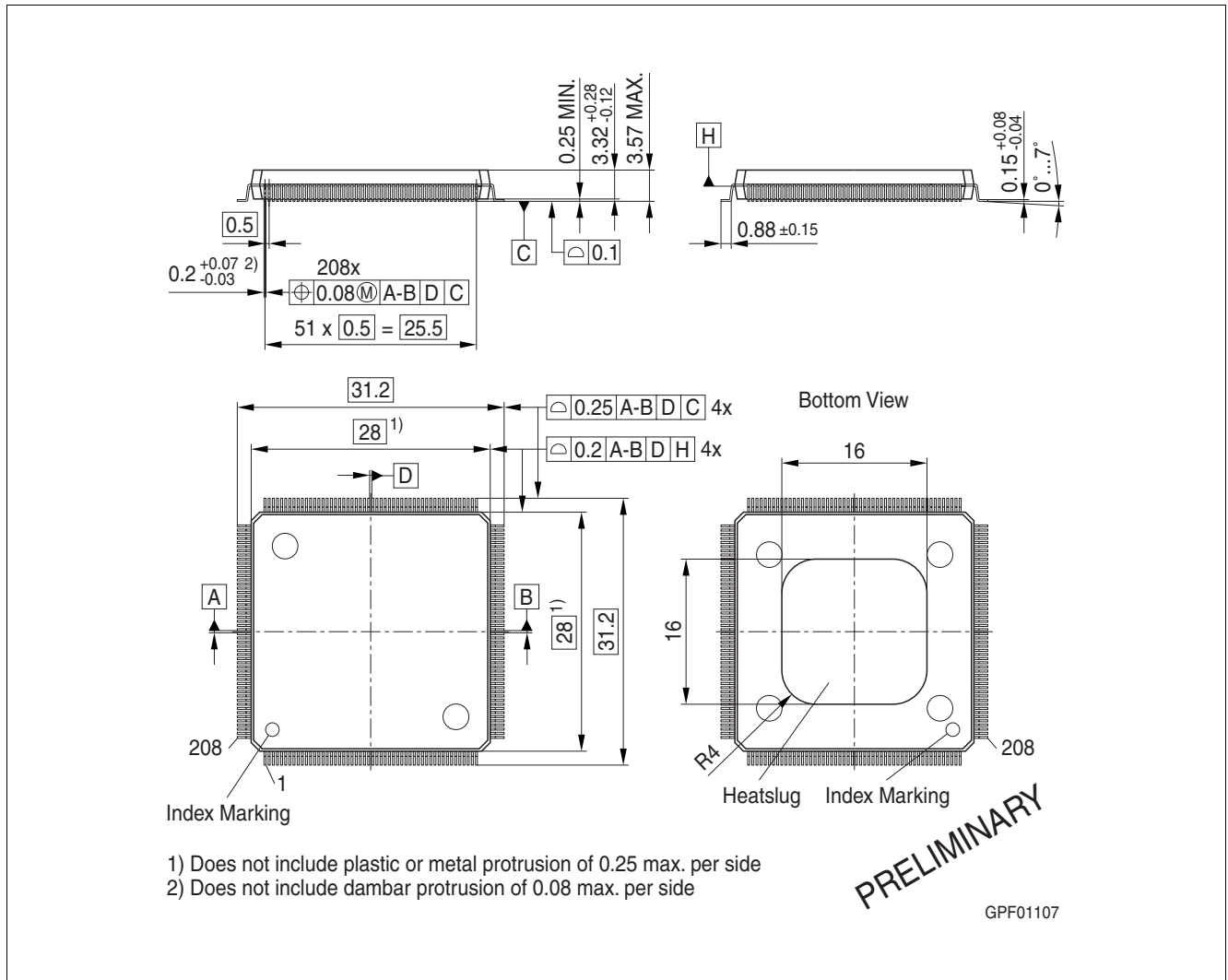

Figure 23 P-FQFP-208-10 (Plastic Quad Flat Package)

Dimensions in mm.

Terminology

A

AHB	Advance High performance Bus
ALE	Address Latch Enable
AN	Auto-Negotiation
APB	Advanced Peripheral Bus
ASB	Advanced System Bus
ASIC	Application Specific Integrated Circuit

B

BC	BroadCast
BP	Back Pressure
BPDU	Bridge Protocol Data Unit
BISS	Build In Self test error Skip
BIST	Build In Self Test

C

CLK	Clock
COL	Collision
CoS	Class of Service
CRC	Cyclic Redundancy Check
CRS	Carrier Sense
CSX	Chip Select for external I/O bank0

D

DFE	Decision Feedback Equalization
DMA	Direct Memory Access

F

FC	Flow Control
FIFO	First-In-First-Out

G

GND	Ground
GPIO	General Purpose I/O
GPIO_L	GPIO of groupL
GPIO_M	GPIO of groupM
GPSI	General Purpose Serial Interface

H

HOL	Head-on-Line
-----	--------------

I

INTC	Interrupt Control Registers
INTX	Interrupt for external I/O bank0
IPG	Inter Packet Gap
IRQ	Interrupt ReQuest

J

JTAG	Joint Test Action Group
------	-------------------------

L	
LSb	Least Significant Bit
LSB	Least Significant Byte
M	
MAC	Media Access Control
MC	Multicast
MDC	Management Data Clock
MDIO	Management Data I/O
MDI	Medium dependent interface
MDIX	MDI Crossover
MII	Media Independent Interface
MIPS	Million Instructions Per Second
MMU	Memory Management Unit
N	
NAT	Network Address Translation
NRZI	Non Return Zero Invert
NRZ	Non Return Zero
P	
PCS	Physical Coding Sublayer
PHY	PHYSical Layer
PLL	Phase Locked Loop
PMA	Physical Medium Attachment
PMD	Physical medium Dependent
PQFP	Plastic Quad Flat Package
R	
RISC	Reduced Instruction Set Computer
RX	Receive
RXD	Receive Data
RXDV	Receive Data Valid
S	
SA	Source Address
SMC	Flash Control Registers
SW	Switch
SYSC	System Control Registers
T	
TOS	Type Of Service
TX	Transmit
TXC	Transmit Clock
TXE	Transmit Enable
TXD	Transmit Data
U	
UART	Universal Asynchronous Receiver Transmitter
V	

VLAN

Virtual LAN

W

WAN

Wide Area Networks

www.infineon.com

Published by Infineon Technologies AG