

Samurai

6 Port 10/100 Mbit/s Single Chip Ethernet Switch
Controller (ADM6996LCX - Green Package
Version; ADM6996LHX - Heat Sink and Green
Package)
Version AC

Communications



Never stop thinking

Edition 2005-12-05

**Published by Infineon Technologies AG,
St.-Martin-Strasse 53,
81669 München, Germany**

**© Infineon Technologies AG 2005.
All Rights Reserved.**

Attention please!

The information herein is given to describe certain components and shall not be considered as a guarantee of characteristics.

Terms of delivery and rights to technical change reserved.

We hereby disclaim any and all warranties, including but not limited to warranties of non-infringement, regarding circuits, descriptions and charts stated herein.

Information

For further information on technology, delivery terms and conditions and prices please contact your nearest Infineon Technologies Office (www.infineon.com).

Warnings

Due to technical requirements components may contain dangerous substances. For information on the types in question please contact your nearest Infineon Technologies Office.

Infineon Technologies Components may only be used in life-support devices or systems with the express written approval of Infineon Technologies, if a failure of such components can reasonably be expected to cause the failure of that life-support device or system, or to affect the safety or effectiveness of that device or system. Life support devices or systems are intended to be implanted in the human body, or to support and/or maintain and sustain and/or protect human life. If they fail, it is reasonable to assume that the health of the user or other persons may be endangered.

Samurai 6 Port 10/100 Mbit/s Single Chip Ethernet Switch Controller (ADM6996LCX - Green Package Version)**Revision History: 2005-12-05, Rev. 1.31****Previous Version: 2005-04-28, Rev.1.1**

Page/ Date	Subjects (major changes since last revision)
Page19	Modify LNKFP5 pin description
Page 71~156	Add 16bits mode registers description
2005-08-30	Changed to the new Infineon format
2005-08-30	Rev. 1.1 changed to Rev. 1.3 Update in content
2005-11-07	Revision 1.3 changed to Revision 1.31 Minor change. Included Green package information and heat sind information

Trademarks

ABM[®], AOP[®], BlueMoon[®], ConverGate[®], C166[®], DuSLIC[®], FALC[®], GEMINAX[®], INCA[®], IOM[®], IPVD[®], Isac[®], IWE[®], IWORX[®], MuSLIC[®], OCTALFALC[®], OCTAT[®], QUADFALC[®], SCOUT[®], SEROCCO[®], S-GOLD[®], SICOFI[®], SIEGET[®], SMARTI[®], SOCRATES[®], VINETIC[®], WDTC[®], 10BaseS[®] are registered trademarks of Infineon Technologies AG.

ACE[™], ARCOFI[™], ASM[™], ASP[™], BlueNIX[™], DigiTape[™], DUALFALC[™], EasyPort[™], E-GOLD[™], E-GOLDlite[™], EPIC[™], IPAT-2[™], ELIC[™], IDEC[™], ITAC[™], M-GOLD[™], SCT[™], S-GOLD2[™], S-GOLD3[™], MUSAC[™], POTSWIRE[™], QUAT[™], S-GOLDlite[™], SICAT[™], SIDEC[™], SLICOFI[™], VDSLite[™], 10BaseV[™], 10BaseVX[™] are trademarks of Infineon Technologies AG.

Microsoft[®] and Visio[®] are registered trademarks of Microsoft Corporation. Linux[®] is a registered trademark of Linus Torvalds. FrameMaker[®] is a registered trademark of Adobe Systems Incorporated. APOXI[®] is a registered trademark of Comneon GmbH & Co. OHG. PrimeCell[®], RealView[®], ARM[®] are registered trademarks of ARM Limited. OakDSPCore[®], TeakLite[®] DSP Core, OCEM[®] are registered trademarks of ParthusCeva Inc.

IndoorGPS[™], GL-20000[™], GL-LN-22[™] are trademarks of Global Locate. ARM926EJ-S[™], ADS[™], Multi-ICE[™] are trademarks of ARM Limited.

Table of Contents

	Table of Contents	4
	List of Figures	7
	List of Tables	8
1	Product Overview	10
1.1	Overview	10
1.2	Features	10
1.3	Applications	11
1.4	Block Diagram	12
2	Interface Description	13
2.1	Pin Diagram	13
2.2	Abbreviations	14
2.3	Pin Description by Function	14
3	Function Description	24
3.1	Functional Descriptions	24
3.2	10/100M PHY Block	24
3.3	100Base-X Module	24
3.4	100Base-X Receiver	24
3.4.1	A/D Converter	25
3.4.2	Adaptive Equalizer and timing Recovery Module	25
3.4.3	NRZI/NRZ and Serial/Parallel Decoder	25
3.4.4	Data De-scrambling	25
3.4.5	Symbol Alignment	25
3.4.6	Symbol Decoding	25
3.4.7	Valid Data Signal	26
3.4.8	Receive Errors	26
3.4.9	100Base-X Link Monitor	26
3.4.10	Carrier Sense	26
3.4.11	Bad SSD Detection	26
3.4.12	Far-End Fault	26
3.5	100Base-TX Transceiver	27
3.5.1	Transmit Drivers	27
3.5.2	Twisted-Pair Receiver	27
3.6	10Base-T Module	27
3.6.1	Operation Modes	27
3.6.2	Manchester Encoder/Decoder	27
3.6.3	Transmit Driver and Receiver	28
3.6.4	Smart Squelch	28
3.7	Carrier Sense	28
3.8	Jabber Function	28
3.9	Link Test Function	28
3.10	Automatic Link Polarity Detection	29
3.11	Clock Synthesizer	29
3.12	Auto Negotiation	29
3.13	Memory Block	29
3.14	Switch Functional Description	29
3.15	Basic Operation	29
3.15.1	Address Learning	30

3.15.2	Address Recognition and Packet Forwarding	30
3.15.3	Address Aging	30
3.15.4	Back off Algorithm	30
3.15.5	Inter-Packet Gap (IPG)	30
3.15.6	Illegal Frames	31
3.15.7	Half Duplex Flow Control	31
3.15.8	Full Duplex Flow Control	31
3.15.9	Old Broadcast Storm filter (0x0b[0]=0 and 0x11[6]=0)	31
3.15.10	New Broadcast/Multicast Storm (0x0b[0]=1 and 0x11[6]=1)	31
3.16	Auto TP MDIX function	32
3.17	Port Locking	32
3.18	VLAN setting & Tag/Untag & port-base VLAN	32
3.19	Old Fixed Ingress Bandwidth Control (0x0b[0]=0)	33
3.20	New Scalable Egress/Ingress Bandwidth Control (0x0b[0]=1 and 0x33[12]=1)	33
3.21	MAC Table Accessible	33
3.22	Priority Setting	33
3.23	LED Display	34
3.23.1	Single Color LED Display	34
3.23.2	Dual Color LED Display	35
3.23.3	Circuit for Single LED Mode	36
3.23.4	Circuit for Dual Led Mode	36
3.24	MAC Clone and Port5 MII connection	37
3.25	The Hardware Difference between ADM6996LC/LCX/I and ADM6996L	40
4	32 Bits Mode Registers Description	41
4.1	EEPROM Registers (0x0b[0]=0)	41
4.1.1	EEPROM Register Descriptions	43
4.2	Serial Registers	62
4.2.1	Serial Register Map	63
4.3	Packet with Priority: Normal packet content	70
4.4	VLAN Packet	70
4.5	TOS IP Packet	71
4.6	EEPROM Access	71
4.7	Serial Interface Timing	72
5	16 Bits Mode Registers Description	74
5.1	EEPROM Basic Registers	85
5.2	EEPROM Extended Registers	121
5.3	Counter and Switch Status Registers	131
5.4	PHY Registers	148
6	Hardware, EEPROM and SMI Interface for Configuration	159
6.1	Hardware Setting	159
6.2	EEPROM Interface	160
6.3	SMI Interface	161
7	Electrical Specification	163
7.1	TX/FX Interface	163
7.1.1	TP Interface	163
7.1.2	FX Interface	164
7.2	DC Characterization	164
7.3	AC Characterization	166
7.3.1	XTAL/OSC Timing	166
7.3.2	Power On Reset	167

Table of Contents

7.3.3	EEPROM Interface Timing	167
7.3.4	10Base-TX MII Input Timing	168
7.3.5	10Base-TX MII Output Timing	169
7.3.6	100Base-TX MII Input Timing	170
7.3.7	100Base-TX MII Output Timing	171
7.3.8	RMII REFCLK Input Timing	171
7.3.9	RMII REFCLK Output Timing	172
7.3.10	Reduce MII Timing	173
7.3.11	GPSI (7-wire) Input Timing	174
7.3.12	GPSI (7-wire) Output Timing	175
7.3.13	SDC/SDIO Timing	175
8	Package Outlines	177
8.1	Package Information	177
	Terminology	178

List of Figures

Figure 1	ADM6996LC/LCX/LHX Block Diagram	12
Figure 2	5 TP/FX PORT + 1 MII PORT 128 Pin Diagram	13
Figure 3	Circuit for Single Color LED Mode	36
Figure 4	Circuit for Dual Color LED Mode	36
Figure 5	ADM6996LC/LCX to CPU with single MII Connection	37
Figure 6	MAC Clone Enable and VLAN Setting	38
Figure 7	100M Full duplex MAC to MAC MII Connection	39
Figure 8	Old Router Architecture Example	50
Figure 9	New Router Architecture using ADM6996LC/LCX/LHX	51
Figure 10	CPU Generated Reset Signal Requirement	72
Figure 11	CPU Write EEPROM Command Requirement	72
Figure 12	Serial Interface Read Command Timing	72
Figure 13	Serial Interface Reset Command Timing	73
Figure 14	Interconnection between ADM6996LC/LCX/LHX, EEPROM and CPU	159
Figure 15	TP Interface	163
Figure 16	FX Interface	164
Figure 17	XTAL/OSC Timing	166
Figure 18	Power On Reset Timing	167
Figure 19	EEPROM Interface Timing	167
Figure 20	10Base-TX MII Input Timing	168
Figure 21	10Base-TX MII Output Timing	169
Figure 22	100Base-TX MII Input Timing	170
Figure 23	100Base-TX MII Output Timing	171
Figure 24	RMII REFCLK Input Timing	171
Figure 25	RMII REFCLK Output Timing	172
Figure 26	Reduce MII Timing (1 of 2)	173
Figure 27	Reduce MII Timing (2 of 2)	173
Figure 28	GPSI (7-wire) Input Timing	174
Figure 29	GPSI (7-wire) Output Timing	175
Figure 30	SDC/SDIO Timing	175
Figure 31	P-PQFP-128 Outside Dimension	177

List of Tables

Table 1	Abbreviations for Pin Type	14
Table 2	Abbreviations for Buffer Type	14
Table 3	IO Signals	15
Table 4	The max. packet number = 7490 in 100Base, 749 in 10Base	31
Table 5	The max. packet number = 7490 in 100Base, 749 in 10Base	31
Table 6	Fixed Ingress Bandwidth Control	33
Table 7	Single Color LED Display	34
Table 8	Dual Color LED Display	36
Table 9	Pin Description(QFP128)	40
Table 10	Registers Address Space	41
Table 11	Registers Overview	41
Table 12	Register Access Types	42
Table 13	Registers Clock Domains	43
Table 14	Basic Control Registers 1 to 4	45
Table 15	Reserved Register 1 to 3	45
Table 16	Reserved Register 6	47
Table 17	The max. packet number = 7490 in 100Base, 749 in 10Base	49
Table 18	The max. packet number = 7490 in 100Base, 749 in 10Base	49
Table 19	Drop Scheme for Each Queue	49
Table 20	VLAN Mapping Table Registers 1 to 15	54
Table 21	Reserved Register 8 to 11	55
Table 22	Note: Reference Table	60
Table 23	Registers Address Space	62
Table 24	Registers Overview	62
Table 25	Registers Clock Domains	63
Table 26	Per Port Counters	67
Table 27	Ethernet Packet from Layer 2	70
Table 28	VLAN Packet	70
Table 29	IP Packet	71
Table 30	RESETL & EEPROM content relationship	71
Table 31	Broadcast Storming Threshold	74
Table 32	Priority Queue Weight Ratio	74
Table 33	Registers Address Space	75
Table 34	Registers Overview	75
Table 35	Register Access Types	83
Table 36	Registers Clock Domains	84
Table 37	Basic Control Registers 1 to 5	86
Table 38	Reserved Registers	87
Table 39	PxSO Registers	96
Table 40	VFxL Registers	122
Table 41	VFxH Registers	123
Table 42	TFx Registers	124
Table 43	PFx Registers	125
Table 44	TUFx Registers	125
Table 45	CLx Registers	135
Table 46	CHx Registers	136
Table 47	PHY_Cx Registers	150
Table 48	PHY_Sx Registers	152
Table 49	PHY_Ix_A Registers	153

List of Tables

Table 50	PHY_Ix_B Registers	153
Table 51	ANAPx Registers	155
Table 52	ANLPx Registers	156
Table 53	ANEx Registers	157
Table 54	NPTx Registers	158
Table 55	LPNPx Registers	159
Table 56	Hardware Setting	159
Table 57	(D) The Pin Type of EECS, EESK, EDI and EDO during the Operation	162
Table 58	Power Consumption	164
Table 59	Absolute Maximum Ratings	165
Table 60	Recommended Operating Conditions	165
Table 61	DC Electrical Characteristics for 3.3 V Operation	166
Table 62	XTAL/OSC Timing	166
Table 63	Power On Reset Timing	167
Table 64	EEPROM Interface Timing	167
Table 65	10Base-TX MII Input Timing	168
Table 66	10-Base-TX MII Output Timing	169
Table 67	100Base-TX MII Input Timing	170
Table 68	100Base-TX MII Output Timing	171
Table 69	RMII REFCLK Input Timing	172
Table 70	RMII REFCLK Output Timing	172
Table 71	Reduce MII Timing	173
Table 72	GPSI (7-wire) Input Timing	174
Table 73	GPSI (7-wire) Output Timing	175
Table 74	SDC/SDIO Timing	176

1 Product Overview

1.1 Overview

The Samurai (ADM6996LC/LCX/LHX) is a high performance, low cost, highly integrated (Controller, PHY and Memory) five-port 10/100 Mbit/s TX/FX plus one 10/100 MAC port Ethernet switch controller with all ports supporting 10/100 Mb/s Full/Half duplex. The ADM6996LC/LCX/LHX is intended for applications for stand alone bridges for low cost SOHO markets such as Wire/ADSL/Wireless Router, IP Set Top Box, VDSL2, Gateway and HomePNA/HomePlug applications. The ADM6996LCX is the environmentally friendly "green" package version. The LH solution contains a heat sink which can be used in special circumstances but is not recommended for all projects.

ADM6996LC/LCX/LHX provides advanced functions such as: **802.1p(Q.O.S.), Port-based/Tag-based VLAN, Port MAC address Locking, Management, Port Status, MAC Address Access and Bandwidth Control.**

The ADM6996LC/LCX/LHX also supports Back Pressure in Half-Duplex mode and 802.3x Flow Control Pause packet in Full-Duplex mode to prevent packet loss when buffer is full. When Back Pressure is enabled, and there is no receive buffer available for the incoming packet, the ADM6996LC/LCX/LHX will issue a JAM pattern on the receiving port in Half Duplex mode and transmit the 802.3x Pause packet back to receiving end in Full Duplex mode.

The built-in SRAM used for packet buffering is divided into 256 bytes/block to achieve the optimized memory utilization through complicated link lists on packets with various lengths.

ADM6996LC/LCX/LHX also supports priority features by Port-Base, VLAN, IP TOS, TCP/UDP Layer4 destination port number, MAC destination address field checking. Users can be easily set different priority modes in individual ports, through a small low-cost micro controller to initialize or on-the-fly to configure. Each output port supports four queues in the way of fixed N:1 or programmable fairness queuing to fit the bandwidth demand on various types of packets such as Voice, Video and Data. Tag/Untag, and up to 16 groups of VLAN also is supported.

An intelligent address recognition algorithm makes ADM6996LC/LCX/LHX to recognize up to 2K different MAC addresses and enables filtering and forwarding at full wire speed.

Port MAC address Locking function is also supported by ADM6996LC/LCX/LHX to use on Building Internet access to prevent multiple users sharing one port traffic.

1.2 Features

- Supports five 10M/100M auto-detect Half/Full duplex switch ports with TX/FX interfaces and one MII/GPSI port.
- Supports 2K MAC addresses table with 4-ways associative hash algorithm.
- Supports four queue for QoS
- Supports priority features by Port-Based, 802.1p, IP TOS of packets, Layer4 TCP/UDP destination port number and MAC address DA.
- Supports MAC dress accessible such as Search, Add and Delete.
- Supports Egress/Ingress 64K Scalable Bandwidth control.
- Supports Store & Forward architecture and performs forwarding and filtering at non-blocking full wire speed.
- Supports buffer allocation with 256 bytes per block
- Supports Aging function Enable/Disable.
- Supports per port Single/Dual color mode with Power On auto diagnostic.
- Supports 802.3x Flow Control pause packet for Full Duplex in case buffer is full.
- Supports Back Pressure function for Half Duplex operation in case buffer is full.
- Supports packet length up to 1518/1522 (Default)/1536/1784 bytes in maximum.
- Broadcast/Multicast Storm Suppression.

- Supports Tag-based VLAN. Up to 16 VLAN groups is implemented by the last four bits of VLAN ID.
- 2bit MAC clone to support multiple WAN application
- Supports TP interface Auto MDIX function for auto TX/RX swap by strapping-pin.
- Easy Management 32bits smart counter for per port RX/TX byte/packet count, 16-bit smart counter for per port ERROR count and Collision count through serial 32/16 bits mode access. 16 bits mode is MDC/MDIO timing compatible.
- Supports PHY status output for management system.
- 25M Crystal only for the whole system.
- 128 QFP package with 0.18um technology. 1.8 V/3.3 V power supply.
- 1.0 W low power consumption.

1.3 Applications

ADM6996LC/LCX/LHX in 128-pin PQFP:

- Wire/ADSL/Wireless/VDSL2 Router
- IP Setop Box, HomePNA, HomePlug application.

1.4 Block Diagram

Figure 1 below shows a simple block diagram of the ADM6996LC/LCX/LHX internal blocks.

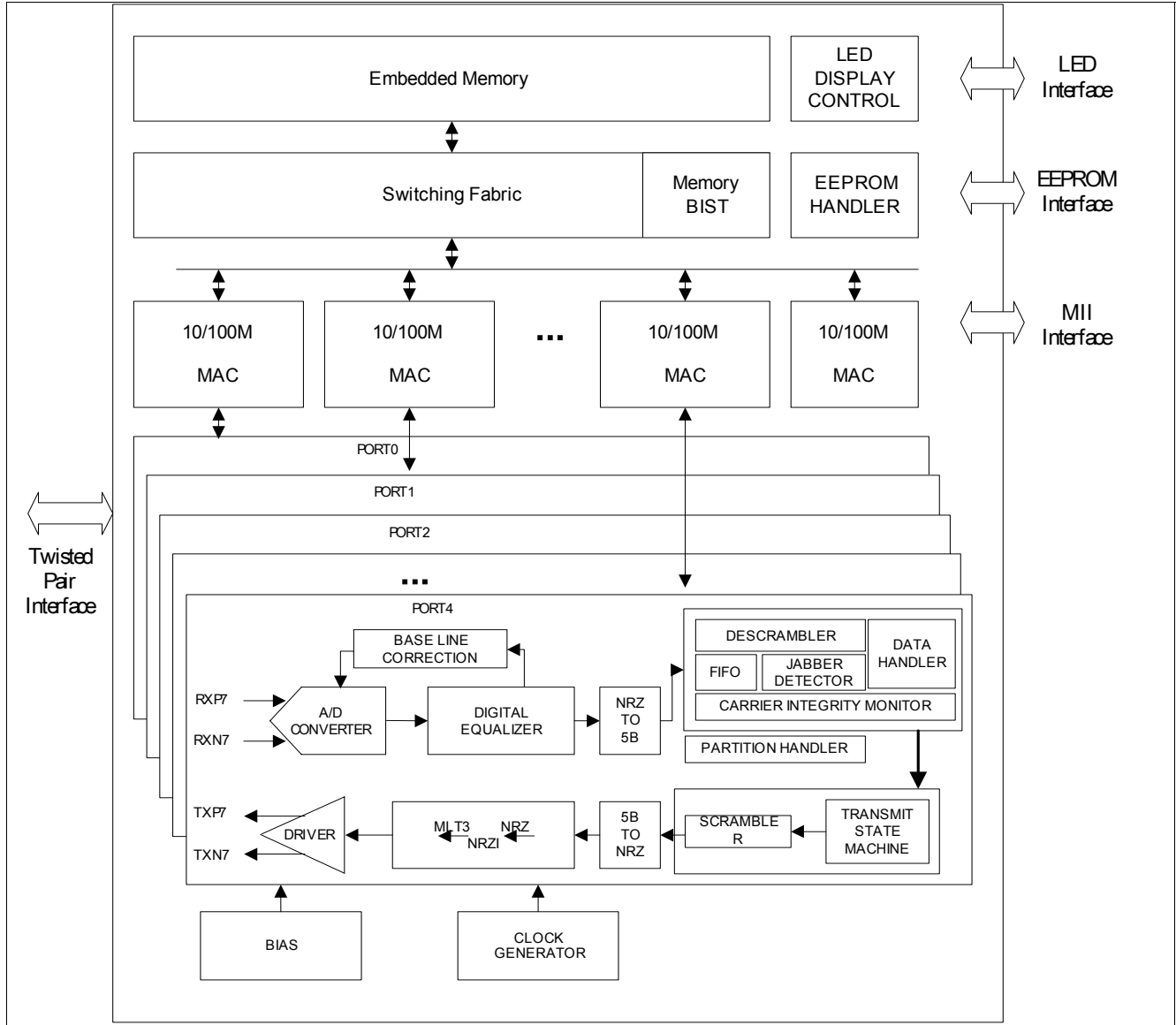

Figure 1 ADM6996LC/LCX/LHX Block Diagram

2.2 Abbreviations

Standard abbreviations for I/O tables:

Table 1 Abbreviations for Pin Type

Abbreviations	Description
I	Standard input-only pin. Digital levels.
O	Output. Digital levels.
I/O	I/O is a bidirectional input/output signal.
AI	Input. Analog levels.
AO	Output. Analog levels.
A/I/O	Input or Output. Analog levels.
PWR	Power
GND	Ground
MCL	Must be connected to Low (JEDEC Standard)
MCH	Must be connected to High (JEDEC Standard)
NU	Not Usable (JEDEC Standard)
NC	Not Connected (JEDEC Standard)

Table 2 Abbreviations for Buffer Type

Abbreviations	Description
Z	High impedance
PU	Pull up, 10 k Ω
PD	Pull down, 10 k Ω
TS	Tristate capability: The corresponding pin has 3 operational states: Low, high and high-impedance.
OD	Open Drain. The corresponding pin has 2 operational states, active low and tristate, and allows multiple devices to share as a wire-OR. An external pull-up is required to sustain the inactive state until another agent drives it, and must be provided by the central resource.
OC	Open Collector
PP	Push-Pull. The corresponding pin has 2 operational states: Active-low and active-high (identical to output with no type attribute).
OD/PP	Open-Drain or Push-Pull. The corresponding pin can be configured either as an output with the OD attribute or as an output with the PP attribute.
ST	Schmitt-Trigger characteristics
TTL	TTL characteristics

2.3 Pin Description by Function

ADM6996LC/LCX/LHX pins are categorized into one of the following groups:

- Network Media Connection
- Port 5 MII Interface
- LED Interface
- EEPROM Interface
- Power/Ground, 48 pins
- Miscellaneous

Note: [Table 1](#) can be used for reference.

Table 3 IO Signals

Ball No.	Name	Pin Type	Buffer Type	Function
Network Media Connection				
41	RXP_4	AI/O	ANA	Receive Pair Differential data is received on this pin.
37	RXP_3			
24	RXP_2			
11	RXP_1			
126	RXP_0			
40	RXN_4	AI/O	ANA	
38	RXN_3			
25	RXN_2			
12	RXN_1			
127	RXN_0			
44	TXP_4	AI/O	ANA	Transmit Pair Differential data is transmitted on this pin.
34	TXP_3			
21	TXP_2			
8	TXP_1			
123	TXP_0			
43	TXN_4	AI/O	ANA	
35	TXN_3			
22	TXN_2			
9	TXN_1			
124	TXN_0			
Port 5 MII Interface				
63	GFCEN	I	PU, LVTTTL	Global Flow Control Enable Value on this pin will be latched by ADM6996LC/LCX/LHX at the rising edge of RESETL(RC) as Flow control enable. <i>Note: Power On Setting</i> 0 _B Flow Control Capability is depended upon the register setting in corresponding EEPROM register 1 _B All ports flow control capability is enabled
	MII_TXD0	O	4 mA, PU, LVTTTL	Port 5 Transmit Data Bit 0 in MII Mode The bit[0] of MII Transmit data of port 5. Synchronous to the rising edge of MII_TXCLK.
	GPSI_TXD	O	4 mA, PU, LVTTTL	Port 5 Transmit Data in GPSI Mode When port 5 is operating in GPSI mode, this pin acts as GPSI Transmit Data. Synchronous to the rising edge of GPSI_TXCLK.
	RMII_TXD0	O	4 mA, PU, LVTTTL	Port 5 Transmit Data Bit 0 in RMII Mode When port 5 is operating in RMII mode, this pin acts as RMII Transmit Data Bit [0]. Synchronous to the rising edge of REFCLK_IN.

Table 3 IO Signals (cont'd)

Ball No.	Name	Pin Type	Buffer Type	Function
61	P5_BUSMD0	I	PD, LVTTTL	<p>Port 5 Bus Mode Selection Bit 0 Value on this pin will be latched by ADM6996LC/LCX/LHX at the rising edge of RESETL as port 5 bus mode selection bit 0. Combined with P5_BUSMD1, ADM6996LC/LCX/LHX provides 3 bus type for port 5. P5_BUSMD[1:0], Interface <i>Note: Power On Setting</i></p> <p>00_B MII 01_B GPSI 10_B RMII 11_B Reserved and not allowed</p>
	MII_TXD1	O	4 mA, PD, LVTTTL	<p>Port 5 Transmit Data Bit 1 in MII Mode The bit[1] of MII Transmit data of port 5. Synchronous to the rising edge of MII_TXCLK.</p>
	RMII_TXD1	O	4 mA, PD, LVTTTL	<p>Port 5 Transmit Data Bit 1 in RMII Mode The bit[1] of RMII Transmit data of port 5. Synchronous to the rising edge of REFCLK_IN.</p>
60	P5_BUSMD1	I	PD, LVTTTL	<p>Port 5 Bus Mode Selection Bit 1 Value on this pin will be latched by ADM6996LC/LCX/LHX at the rising edge of RESETL as port 5 bus mode selection bit 1. Combined with P5_BUSMD0, ADM6996LC/LCX/LHX provides 3 bus type for port 5. <i>Note: Power On Setting</i></p>
	MII_TXD2	O	4 mA, PD, LVTTTL	<p>Port 5 Transmit Data Bit 2 in MII Mode The bit[2] of MII Transmit data of port 5. Synchronous to the rising edge of MII_TXCLK.</p>
59	SDIO_MD	I	PD, LVTTTL	<p>SDC/SDIO Mode Selection Value on this pin will be latched by ADM6996LC/LCX/LHX at the rising edge of RESETL for SDIO 32/16 bits selection. 0_B 32 Bits Mode 1_B 16 Bits Mode. Same timing as MDC/MDIO.</p>
	MII_TXD3	O	4 mA, PD, LVTTTL	<p>Port 5 Transmit Data Bit 3 in MII Mode The bit[3] of MII Transmit data of port 5. Synchronous to the rising edge of MII_TXCLK.</p>

Table 3 IO Signals (cont'd)

Ball No.	Name	Pin Type	Buffer Type	Function
66	PHYAS0	I	PD, LVTTTL	PHY Address MSB Bit 0 During power on reset, value will be latched by ADM6996LC/LCX/LHX at the rising edge of RESETL as PHY start address select. PHYAS[1:0] = 00 _B and PHY address starts from 01000 _B . <i>Note: Power On Setting</i>
	MII_TXEN	O	8 mA, PD, LVTTTL	Port 5 Transmit Enable TXEN in MII Mode Active high to indicate that the data on MII_TXD[3:0] is valid. Synchronous to the rising edge of MII_TXCLK.
	GPSI_TXEN	O	8 mA, PD, LVTTTL	Port 5 Transmit Enable TXEN in GPSI Mode Active high to indicate that the data on GPSI_TXD is valid. Synchronous to the rising edge of GPSI_TXCLK.
	RMII_TXEN	O	8 mA, PD, LVTTTL	Port 5 R Transmit Enable TXEN in RMII Mode Active high to indicate that the data on RMII_TXD[1:0] is valid. Synchronous to the rising edge of REFCLK_IN.
74	MII_RXD0	I	PD, LVTTTL	Port 5 Receive Data Bit 0 in MII Mode The bit[0] of MII receive data, synchronous to the rising edge of MII_RXCLK.
	GPSI_RXD	I	PD, LVTTTL	Port 5 Receive Data in GPSI Mode In GPSI Mode, this acts as Receive Data Input, synchronous to the rising edge of GPSI_RXCLK.
	RMII_RXD0	I	PD, LVTTTL	Port 5 Receive Data Bit 0 in RMII Mode The bit[0] of RMII receive data, synchronous to the rising edge of REFCLK_IN.
100	MII_RXD1	I	PD, LVTTTL	Port 5 Receive Data Bit 1 in MII Mode The bit[1] of MII receive data, synchronous to the rising edge of MII_RXCLK.
	RMII_RXD1	I	PD, LVTTTL	Port 5 Receive Data Bit 1 in RMII Mode Bit[1] of RMII receive data, synchronous to the rising edge of REFCLK_IN.
101	MII_RXD2	I	PD, LVTTTL	Port 5 Receive Data Bit 2 in MII Mode The bit[2] of MII receive data. Synchronous to the rising edge of MII_RXCLK.
102	MII_RXD3	I	PD, LVTTTL	Port 5 Receive Data Bit 3 in MII Mode The bit[3] of MII receive data. Synchronous to the rising edge of MII_RXCLK.
73	MII_RXDV	I	PD, LVTTTL	Port 5 Receive Data Valid in MII Mode Active high to indicate that the data on MII_RXD[3:0] is valid. Synchronous to the rising edge of MII_RXCLK.
	RMII_CRSDV	I	PD, LVTTTL	Port 5 Carrier Sense and Receive Data Valid in RMII Mode Active high to indicate that the data on RMII_RXD[1:0] is valid. Synchronous to the rising edge of REFCLK_IN.

Table 3 IO Signals (cont'd)

Ball No.	Name	Pin Type	Buffer Type	Function
68	MII_RXER	I	PD, LVTTTL	Port 5 Receive Error in MII Mode Active high to indicate that there is error on the MII_RXD [3:0]. Upon receiving this signal, ADM6996LC/LCX/LHX will send Error Symbol onto the medium. Only valid in 100M operation.
	RMII_RXER	I	PD, LVTTTL	Port 5 Receive Error in RMII Mode Active high to indicate that there is error on the RMII_RXD[1:0]. Upon receiving this signal, ADM6996LC/LCX/LHX will send Error Symbol onto the medium. Only valid in 100M operation.
77	MII_CRCS	I	PD, LVTTTL	Port 5 Carrier Sense in MII Mode In full duplex mode, MII_P5CRS reflects the receive carrier sense situation on medium only; In Half Duplex, MII_CRCS will be high both in receive and transmit condition.
	GPSI_CRCS	I	PD, LVTTTL	Port 5 Carrier Sense in GPSI Mode In full duplex mode, GPSI_CRCS reflects the receive carrier sense situation on medium only; In Half Duplex, GPSI_CRCS will be high both in receive and transmit condition.
78	MII_COL	I	PD, LVTTTL	Port 5 Collision Input in MII Mode Active high to indicate that there is collision on the medium. Stay low in full duplex operation.
	GPSI_COL	I	PD, LVTTTL	Port 5 Collision Input in GPSI Mode Active high to indicate that there is collision on the medium. Stay low in full duplex operation.
72	MII_RXCLK	I	PD, LVTTTL	Port 5 Receive Clock Input in MII Mode MII_RXDV and MII_RXD[3:0] are synchronous to the rising edge of this clock. It is free running 25 MHz clock in 100M mode and 2.5 MHz clock in 10M mode.
	GPSI_RXCLK	I	PD, LVTTTL	Port 5 Receive Clock Input in GPSI Mode GPSI_RXD are synchronous to the rising edge of this clock. It is non-continuous 10 MHz Clock input.
	REFCLK_IN	I	PD, LVTTTL	50MHz Reference Clock Input in RMII mode RMII_RXD[1:0], RMII_TXD[1:0], RMII_TXEN and RMII_CRSDV are synchronous to the rising edge of this clock.
67	MII_TXCLK	I	PD, LVTTTL	Port 5 Transmit Clock Input in MII Mode MII_TXEN and MII_TXD[3:0] are output at the rising edge of this clock. It is free running 25 MHz clock in 100M mode and 2.5 MHz clock in 10M mode.
	GPSI_TXCLK	I	PD, LVTTTL	Port 5 Transmit Clock Input in GPSI Mode GPSI_TXEN and GPSI_TXD are synchronous to the rising edge of this clock. It is continuous 10 MHz Clock input.
	REFCLK_OUT	O	8 mA, PD, LVTTTL	50MHz Reference Clock Output in RMII mode This pin is used as 50 MHz reference clock signal output pin when port 5 operates in RMII mode.

Table 3 IO Signals (cont'd)

Ball No.	Name	Pin Type	Buffer Type	Function
89	SPDTNP5	I	PD, LVTTTL	Port 5 Speed Input 0 _B 100M 1 _B 10M
90	LNKFP5	I	PD, LVTTTL	Port 5 Link Fail Status Input 0 _B Link Up 1 _B Link Failed
91	DPHALFP5	I	PD, LVTTTL	Port 5 Duplex Status Input 0 _B Full Duplex 1 _B Half Duplex
LED Interface				
103	DUPCOL4	O	8 mA, PD, LVTTTL	Port 4 Duplex /Collision LED In Full duplex mode, this pin acts as DUPLEX LED for port 4, respectively; in half duplex mode, it is collision LED for each port. See Chapter 3.23 LED Display for more detail.
106	DUPCOL3	O	8 mA, PD, LVTTTL	Port 3 Duplex /Collision LED In Full duplex mode, this pin acts as DUPLEX LED for port 3, respectively; in half duplex mode, it is collision LED for each port. See Chapter 3.23 LED Display for more detail.
107	BPEN	I	PU, LVTTTL	Recommend Back-Pressure in Half-Duplex The value on this pin will be latched by ADM6996LC/LCX/LHX during power on reset as the beck-pressure enable in half-duplex mode. <i>Note: Power On Setting</i> 0 _B Disable Back-Pressure 1 _B Enable Back-Pressure
	DUPCOL2	O	8 mA, PU, LVTTTL	Port 2 Duplex-collision LED In Full duplex mode, this pin acts as port 2 DUPLEX LED; in half duplex mode, it is collision LED for port 2. See Chapter 3.23 LED Display for more detail.
108	PHYAS1	I	PD, LVTTTL	Recommend PHY Address Bit 1 Value on this pin will be latched by ADM6996LC/LCX/LHX during power on reset as the PHY address recommend value bit 1. See PHYAS0 description for more detail. <i>Note: Power On Setting</i>
	DUPCOL1	O	8 mA, PD, LVTTTL	Port 1 Duplex-collision LED In Full duplex mode, this pin acts as port 1 DUPLEX LED; in half duplex mode, it is collision LED for port 1. See Chapter 3.23 LED Display for more detail.

Table 3 IO Signals (cont'd)

Ball No.	Name	Pin Type	Buffer Type	Function
109	RECANEN	I	PU, LVTTTL	Recommend Auto Negotiation Enable Only valid for Twisted pair interface. Programming this bit to 1 has no effect on the Fiber port. <i>Note: Power On Setting.</i> 0 _B Disable all TP port auto negotiation capability 1 _B Enable all TP port auto negotiation capability
	DUPCOL0	O	8 mA, PU, LVTTTL	Port 0 Duplex-collision LED In Full duplex mode, this pin acts as port 0 DUPLEX LED; in half duplex mode, it is the collision LED for port 0. See Chapter 3.23 LED Display for more detail.
92	LNKACT_4	O	8 mA, PD, LVTTTL	LINK/Activity LED of Port 4 to 0 Used to indicate corresponding port' s link/activity status, see Chapter 3.23 LED Display for more detail.
95	LNKACT_3			
96	LNKACT_2			
97	LNKACT_1			
98	LNKACT_0			
58	LDSPD_4	O	8 mA, PD, LVTTTL	Port 4 to Port 0 Speed LED Used to indicate corresponding port' s speed status, see Chapter 3.23 LED Display for more detail.
55	LDSPD_3			
54	LDSPD_2			
51	LDSPD_1			
50	LDSPD_0			
EEPROM Interface				
84	EDO	I	PU, LVTTTL	EEPROM Data Output This pin is used to input EEPROM data when reading EEPROM. During ADM6996LC/LCX/LHX initialization, ADM6996LC/LCX/LHX will drive EEPROM interface signal to read settings from EEPROM. Any other devices attach to EEPROM interface SHOULD drive Hi-Z or keep tristate during this period. See Chapter 4.6 EEPROM Access for more detail.
80	IFSEL	I	PD, LVTTTL	Interface Selection After ADM6996LC/LCX/LHX initialization, this pin is used to select using EEPROM interface or SDC/SDIO interface. EECS/IFSEL interface 0 _B SDC/SDIO interface 1 _B EEPROM interface
	EECS	O	4 mA, PD, LVTTTL	EEPROM Chip Select During ADM6996LC/LCX/LHX initialization, this pin is used as the EEPROM chip select signal. During ADM6996LC/LCX/LHX initialization, ADM6996LC/LCX/LHX will drive EEPROM interface signal to read settings from the EEPROM. Any other devices attached to the EEPROM interface SHOULD drive Hi-Z or keep tristate during this period. See Chapter 4.6 EEPROM Access for more detail.

Table 3 IO Signals (cont'd)

Ball No.	Name	Pin Type	Buffer Type	Function
81	XOVEN	I	PD, LVTTTL	<p>Cross Over Enable Value on this pin (active low) will be latched by ADM6996LC/LCX/LHX at the rising edge of RESETL for port 4~0 crossover auto detect (Only available in TP interface). <i>Note: Power On Setting.</i></p> <p>0_B Disable 1_B Enable</p>
	EESK	I/O	4 mA, PD, LVTTTL	<p>EEPROM Serial Clock During ADM6996LC/LCX/LHX initialization, this pin is used to output clock to EEPROM. After ADM6996LC/LCX/LHX initialization process is done, this pin is used as EEPROM interface clock input if IFSEL = 1.</p>
	SDC	I	PD, LVTTTL	<p>Serial Management interface Clock input If IFSEL = 0, this pin is used as a serial management interface clock input.</p>
79	LED_MODE	I	PD, LVTTTL	<p>Enable Mac to Choose LED Display Mode Value on this pin will be latched by ADM6996LC/LCX/LHX at the rising edge of RESETL as Dsingle/dual color LED mode control signal. See Chapter 3.23 LED Display for more detail. <i>Note: Power On Setting.</i></p>
	EDI	I/O	8 mA, PD, LVTTTL	<p>EEPROM Serial Data Input During ADM6996LC/LCX/LHX initialization, this pin is used to output address and command to access EEPROM. After the initialization process is done, this pin becomes an input pin to monitor EEPROM data if IFSEL = 1.</p>
	SDIO	I/O	8 mA, PD, LVTTTL	<p>Serial Management interface Data input/Output If IFSEL = 0, this pin is used as data input/output pin of serial management interface.</p>

Power/Ground, 48 Pins

10, 23, 36, 42, 125	GNDA	GND	–	<p>Ground Used by AD Block</p>
7, 20, 33, 45, 122	VCCA2	PWR	–	<p>1.8 V, Power Used by TX Line Driver</p>
13, 26, 39, 128	VCCAD	PWR	–	<p>3.3 V, Power Used by AD Block</p>
119	GNDBIAS	GND	–	<p>Ground Used by Bias Block</p>
121	VCCBIAS	PWR	–	<p>3.3 V, Power Used by Bias Block.</p>
116	GNDPLL	GND	–	<p>Ground Used by PLL</p>

Table 3 IO Signals (cont'd)

Ball No.	Name	Pin Type	Buffer Type	Function
115	VCCPLL	PWR	–	1.8 V, Power Used by PLL
47, 52, 64, 76, 83, 93	GNDIK	GND	–	Ground Used by Digital Core
48, 53, 75, 82, 94, 110	VCCIK	PWR	–	1.8 V, Power Used by Digital Core
46, 57, 70, 87, 99, 104	GNDO	GND	–	Ground Used by Digital Pad
56, 71, 88, 105	VCC3O	PWR	–	3.3 V, Power Used by Digital Pad
Miscellaneous				
62	P4FX	I	PD, LVTTTL	Port 4 Fiber Selection During power on reset, value will be latched by ADM6996LC/LCX/LHX at the rising edge of RESETL as Port 4 Fiber select. 0 _B Twisted Pair Mode 1 _B Fiber Mode
65	INT_N	O	OD,8 mA	Interrupt Active low interrupt signal to indicate the status change in the interrupt status register. Interrupt signal will keep active low until host read the status of ISR register. 0 _B Interrupt 1 _B Not interrupt
69	WAIT_INIT	I	PD, LVTTTL	Wait Initialization This pin will be used to pause all activities after power up until EEPROM is loaded successfully or CPU initialization is done. 0 _B pause until loading EEPROM is done. 1 _B pause until EEPROM successfully loaded or CPU initialization is done.
1, 2, 3, 4, 5, 6, 14, 15, 16, 17, 18, 19, 27, 28, 29, 30, 31, 32	NC	-	-	Not Connected
49	TEST	I	PD, LVTTTL	Test Mode Reserved and should be kept 0 when under normal operation.
86	CFG0	I	PU, LVTTTL	Configuration 0 Reserved and should be kept 0 when under normal operation.
85	CKO25M	O	8 mA, PD, LVTTTL	25MHz Clock Output Free Running 25 MHz Clock output (Even during power on reset)

Table 3 IO Signals (cont'd)

Ball No.	Name	Pin Type	Buffer Type	Function
112	RC	I	ST	RC Input For Power On Reset This pin is sampled by using the 25 MHz free running clock signal which inputs from XI to generate the low-active reset signal, RESETL. See Chapter 7.3.2 Power On Reset for the timing requirement.
113	XI	AI	ANA	25MHz Crystal /Oscillator Input 25MHz Crystal or Oscillator Input. Variation is limited to +/- 50ppm.
114	XO	AO	ANA	25M Crystal Output When connected to oscillator, this pin should be left unconnected.
120	RTX	AI	ANA	Constant Voltage Reference External 1.0 k Ω 1% resistor connection to ground.
118	VREF	AI	ANA	Analog Reference Voltage Used by Internal Bias Circuit for voltage reference. External 0.1 μ F capacitor connection to ground for noise filter.
117	CONTROL	AI/O	ANA	FET Control Signal The pin is used to control FET for 3.3 V to 1.8 V regulator. External 0.1 μ F capacitor connection to ground for noise filter, even the pin is un-connected.

3 Function Description

3.1 Functional Descriptions

The ADM6996LC/LCX/LHX integrates five 100Base-X physical sub-layer (PHY), 100Base-TX physical medium dependent (PMD) transceivers, five complete 10Base-T modules, a 6 port 10/100 switch controller and one 10/100 MII/GPSI MAC and memory into a single chip for both 10Mbit/s, 100Mbit/s Ethernet switch operation. It also supports 100Base-FX operation through external fiber-optic transceivers. The device is capable of operating in either Full Duplex mode or Half-Duplex mode in 10Mbit/s and 100Mbit/s. Operational modes can be selected by hardware configuration pins, software settings of management registers, or determined by the on-chip auto negotiation logic.

The ADM6996LC/LCX/LHX consists of three major blocks:

- 10/100M PHY Block
- Switch Controller Block
- Built-in SSRAM

The interfaces used for communication between the PHY block and switch core is an MII interface.

An auto MDIX function is supported in this block. This function can be Enabled and Disabled by the hardware pin.

3.2 10/100M PHY Block

The 100Base-X section of the device implements the following functional blocks:

- 100Base-X physical coding sub-layer (PCS)
- 100Base-X physical medium attachment (PMA)
- Twisted-pair transceiver (PMD)

The 100Base-X and 10Base-T sections share the following functional blocks:

- Clock synthesizer module
- MII Registers
- IEEE 802.3u auto negotiation

3.3 100Base-X Module

The ADM6996LC/LCX/LHX implements a 100Base-X compliant PCS and PMA and 100Base-TX compliant TP-PMD as illustrated in Figure 2. Bypass options for each of the major functional blocks within the 100Base-X PCS provides flexibility for various applications. 100Mbit/s PHY loop back is included for diagnostic purpose.

3.4 100Base-X Receiver

The 100Base-X receiver consists of functional blocks required to recover and condition the 125Mbit/s receive data stream. The ADM6996LC/LCX/LHX implements the 100Base-X receiving state machine diagram as given in the ANSI/IEEE Standard 802.3u, Clause 24. The 125Mbit/s receive data stream may originate from the on-chip twisted-pair transceiver in a 100Base-TX application. Alternatively, the receive data stream may be generated by an external optical receiver as in a 100Base-FX application.

The receiver block consists of the following functional sub-blocks:

- A/D Converter
- Adaptive Equalizer and timing recovery module
- NRZI/NRZ and serial/parallel decoder
- De-scrambler
- Symbol alignment block
- Symbol Decoder

- Collision Detect Block
- Carrier sense Block
- Stream decoder block

3.4.1 A/D Converter

A high performance A/D converter with a 125 MHz sampling rate converts signals received on the RXP/RXN pins to 6 bits data streams. It possess an auto-gain-control capability that will further improve receive performance especially under long cabling or harsh detrimental signal integrity. Due to high pass characteristic on a transformer, a built in base-line-wander correcting circuit will be cancelled out and its DC level restored.

3.4.2 Adaptive Equalizer and timing Recovery Module

All digital design is especially immune to noise environments and achieves better correlation between production and system testing. Baud rate Adaptive Equalizer/Timing Recovery compensates for line loss induced from twisted pairs and tracks a far end clock at 125M samples per second. Adaptive Equalizer's implemented with Feed forward and Decision Feedback techniques meet the requirement of BER with less than 10⁻¹² for transmission on a CAT5 twisted pair cable ranging from 0 to 120 meters.

3.4.3 NRZI/NRZ and Serial/Parallel Decoder

The recovered data is converted from NRZI to NRZ. The data is not necessarily aligned to the 4B/5B code group's boundary.

3.4.4 Data De-scrambling

The de-scrambler acquires synchronization with the data stream by recognizing idle bursts of 40 or more bits and locking its deciphering Linear Feedback Shift Register (LFSR) to the state of the scrambling LFSR. Upon achieving synchronization, the incoming data is XORed by the deciphering LFSR and de-scrambled.

In order to maintain synchronization, the de-scrambler continuously monitors the validity of the unscrambled data that it generates. To ensure this, a link state monitor and a hold timer are used to constantly monitor the synchronization status. Upon synchronization of the de-scrambler the hold timer starts a 722 micro second countdown. Upon detection of sufficient idle symbols within the 722 micro sec. period, the hold timer will reset and begin a new countdown. This monitoring operation will continue indefinitely given an operating network connection operating with good signal integrity. If the link state monitor does not recognize sufficient unscrambled idle symbols within the 722 micro second period, the de-scrambler will be forced out of the current state of synchronization and reset in order to re-acquire synchronization.

3.4.5 Symbol Alignment

The symbol alignment circuit in the ADM6996LC/LCX/LHX determines code word alignment by recognizing the /J/K delimiter pair. This circuit operates on unaligned data from the de-scrambler. Once the /J/K symbol pair (11000 10001_B) is detected, subsequent data is aligned on a fixed boundary.

3.4.6 Symbol Decoding

The symbol decoder functions is a look-up table that translates incoming 5B symbols into 4B nibbles as shown in Table 1. The symbol decoder first detects the /J/K symbol pair preceded by idle symbols and replaces the symbol with a MAC preamble. All subsequent 5B symbols are converted to the corresponding 4B nibbles for the duration of the entire packet. This conversion ceases upon the detection of the /T/R symbol pair denoting the end of stream delimiter (ESD). The translated data is presented on the internal RXD[3:0] signal lines where RXD[0] represents the least significant bit of the translated nibble.

3.4.7 Valid Data Signal

The valid data signal (RXDV) indicates that recovered and decoded nibbles are being presented on the internal RXD[3:0] synchronous receive clock, RXCLK. RXDV is asserted when the first nibble of a translated /J/K is ready for transfer over the internal MII. It remains active until either the /T/R delimiter is recognized, link test indicates failure, or no signal is detected. On any of these conditions, RXDV is de-asserted.

3.4.8 Receive Errors

The RXER signal is used to communicate receiver error conditions. While the receiver is in a state of holding RXDV asserted, the RXER will be asserted for each code word that does not map to a valid code-group.

3.4.9 100Base-X Link Monitor

The 100Base-X link monitor function allows the receiver to ensure that reliable data is being received. Without reliable data reception, the link monitor will halt both transmit and receive operations until such time that a valid link is detected.

The ADM6996LC/LCX/LHX performs the link integrity test as outlined in IEEE 100Base-X (Clause 24) link monitor state diagram. The link status is multiplexed with 10Mbit/s link status to form the reportable link status bit in the serial management register 1h, and driven to the LNKACT pin.

When persistent signal energy is detected on the network, the logic moves into a Link-Ready state after approximately 500 micro secs, and waits for an enable from the auto negotiation module. When received, the link-up state is entered, and the transmission and reception logic blocks become active. Should auto negotiation be disabled, the link integrity logic moves immediately to the link-up state after entering the link-ready state.

3.4.10 Carrier Sense

Carrier sense (CRS) for 100Mbit/s operation is asserted upon the detection of two non contiguous zeros occurring within any 10-bit boundary of the received data stream.

The carrier sense function is independent of symbol alignment. In switch mode, CRS is asserted during either packet transmission or reception. For repeater mode, CRS is asserted only during packet reception. When the idle symbol pair is detected in the received data stream, CRS is de-asserted. In repeater mode, CRS is only asserted due to receive activity. CRS is intended to encapsulate RXDV.

3.4.11 Bad SSD Detection

A Bad Start of Stream Delimiter (Bad SSD) is an error condition that occurs in the 100Base-X receiver if a carrier is detected (CRS asserted) and a valid /J/K set of code-group (SSD) is not received.

If this condition is detected, then the ADM6996LC/LCX/LHX will assert RXER and present RXD[3:0] = 1110_B to the internal MII for the cycles that correspond to received 5B code-groups until at least two idle code-groups are detected. Once at least two idle code groups are detected, RXER and CRS become de-asserted.

3.4.12 Far-End Fault

Auto negotiation provides a mechanism for transferring information from the Local Station to the link Partner that a remote fault has occurred for 100Base-TX. As auto negotiation is not currently specified for operation over fiber, the far end fault indication function (FEFI) provides this capability for 100Base-FX applications.

A remote fault is an error in the link that one station can detect while the other cannot. An example of this is a disconnected wire at a station's transmitter. This station will be receiving valid data and detect that the link is good via the link integrity monitor, but will not be able to detect that its transmission is not propagating to the other station.

A 100Base-FX station that detects such a remote fault may modify its transmitted idle stream from all 1_B's to a group of 84 1_B's followed by a single 0_B. This is referred to as the FEFI idle pattern.

3.5 100Base-TX Transceiver

The ADM6996LC/LCX/LHX implements a TP-PMD compliant transceiver for 100Base-TX operation. The differential transmit driver is shared by the 10Base-T and 100Base-TX subsystems. This arrangement results in one device that uses the same external magnetic for both the 10Base-T and the 100Base-TX transmissions with a simple RC component connection. The individually wave-shaped 10Base-T and 100Base-TX transmit signals are multiplexed in the transmission output driver selection.

3.5.1 Transmit Drivers

The ADM6996LC/LCX/LHX 100Base-TX transmission driver implements MLT-3 translation and wave-shaping functions. The rise/fall time of the output signal is closely controlled to conform to the target range as specified in the ANSI TP-PMD standard.

3.5.2 Twisted-Pair Receiver

For 100Base-TX operation, the incoming signal is detected by the on-chip twisted-pair receiver that consists of a differential line receiver, an adaptive equalizer and a base-line wander compensation circuits.

The ADM6996LC/LCX/LHX uses an adaptive equalizer that changes filter frequency response in accordance with cable length. The cable length is estimated based on the incoming signal strength. The equalizer tunes itself automatically for any cable length to compensate for the amplitude and phase distortions incurred from the cable.

3.6 10Base-T Module

The 10Base-T Transceiver Module is IEEE 802.3 compliant. It includes the receiver, transmitter, collision, heartbeat, loop back, jabber, wave shaper, and link integrity functions, as defined in the standard. Figure 3 provides an overview for the 10Base-T module.

The ADM6996LC/LCX/LHX 10Base-T module is comprised of the following functional blocks:

- Manchester encoder and decoder
- Collision detector
- Link test function
- Transmit driver and receiver
- Serial and parallel interface
- Jabber and SQE test functions
- Polarity detection and correction

3.6.1 Operation Modes

The ADM6996LC/LCX/LHX 10Base-T module is capable of operating in either half-duplex mode or full-duplex mode. In half-duplex mode, the ADM6996LC/LCX/LHX functions as an IEEE 802.3 compliant transceiver with fully integrated filtering. The COL signal is asserted during collisions or jabber events, and the CRS signal is asserted during transmit and receive. In full duplex mode the ADM6996LC/LCX/LHX can simultaneously transmit and receive data.

3.6.2 Manchester Encoder/Decoder

Data encoding and transmission begins when the transmission enable input (TXEN) goes high and continues as long as the transceiver is in a good link state. Transmission ends when the transmission enable input goes low. The last transition occurs at the center of the bit cell if the last bit is a 1_B, or at the boundary of the bit cell if the last bit is 0_B.

Decoding is accomplished using a differential input receiver circuit and a phase-locked loop that separate the Manchester-encoded data stream into clock signals and NRZ data. The decoder detects the end of a frame when

no more mid bit transitions are detected. Within one and a half bit times after the last bit, carrier sense is de-asserted.

3.6.3 Transmit Driver and Receiver

The ADM6996LC/LCX/LHX integrates all the required signal conditioning functions in its 10Base-T block such that external filters are not required. Only one isolation transformer and impedance matching resistors are needed for the 10Base-T transmit and receive interface. The internal transmit filtering ensures that all the harmonics in the transmission signal are attenuated properly.

3.6.4 Smart Squelch

The smart squelch circuit is responsible for determining when valid data is present on the differential receive. The ADM6996LC/LCX/LHX implements an intelligent receive squelch on the RXP/RXN differential inputs to ensure that impulse noise on the receive inputs will not be mistaken for a valid signal. The squelch circuitry employs a combination of amplitude and timing measurements (as specified in the IEEE 802.3 10Base-T standard) to determine the validity of data on the twisted-pair inputs.

The signal at the start of the packet is checked by the analog squelch circuit and any pulses not exceeding the squelch level (either positive or negative, depending upon polarity) will be rejected. Once this first squelch level is overcome correctly, the opposite squelch level must then be exceeded within 150ns. Finally, the signal must exceed the original squelch level within an additional 150ns to ensure that the input waveform will not be rejected.

Only after all these conditions have been satisfied will a control signal be generated to indicate to the remainder of the circuitry that valid data is present.

Valid data is considered to be present until the squelch level has not been generated for a time longer than 200 ns, indicating the end of a packet. Once good data has been detected, the squelch levels are reduced to minimize the effect of noise, causing premature end-of-packet detection. The receive squelch threshold level can be lowered for use in longer cable applications. This is achieved by setting bit 10 of register address 11_H.

3.7 Carrier Sense

Carrier Sense (CRS) is asserted due to receive activity once valid data is detected via the smart squelch function. For 10 Mbit/s half duplex operation, CRS is asserted during either packet transmission or reception. For 10 Mbit/s full duplex and repeater mode operations, the CRS is asserted only due to receive activity.

3.8 Jabber Function

The jabber function monitors the ADM6996LC/LCX/LHX output and disables the transmitter if it attempts to transmit a longer than legal sized packet. If TXEN is high for greater than 24ms, the 10Base-T transmitter will be disabled. Once disabled by the jabber function, the transmitter stays disabled for the entire time that the TXEN signal is asserted. This signal has to be de-asserted for approximately 256 ms (the un-jab time) before the jabber function re-enables the transmit outputs. The jabber function can be disabled by programming bit 4 of register address 10_H to high.

3.9 Link Test Function

A link pulse is used to check the integrity of the connection with the remote end. If valid link pulses are not received, the link detector disables the 10Base-T twisted-pair transmitter, receiver, and collision detection functions.

The link pulse generator produces pulses as defined in IEEE 802.3 10Base-T standard. Each link pulse is nominally 100ns in duration and is transmitted every 16 ms, in the absence of transmit data.

3.10 Automatic Link Polarity Detection

The ADM6996LC/LCX/LHX's 10Base-T transceiver module incorporates an "automatic link polarity detection circuit". The inverted polarity is determined when seven consecutive link pulses of inverted polarity or three consecutive packets are received with inverted end-of-packet pulses. If the input polarity is reversed, the error condition will be automatically corrected and reported in bit 5 of register 10_H.

3.11 Clock Synthesizer

The ADM6996LC/LCX/LHX implements a clock synthesizer that generates all the reference clocks needed from a single external frequency source. The clock source must be a TTL level signal at 25 MHz +/- 50ppm

3.12 Auto Negotiation

The Auto Negotiation function provides a mechanism for exchanging configuration information between two ends of a link segment and automatically selecting the highest performance mode of operation supported by both devices. Fast Link Pulse (FLP) Bursts provide the signaling used to communicate auto negotiation abilities between two devices at each end of a link segment. For further detail regarding auto negotiation, refer to Clause 28 of the IEEE 802.3u specification. The ADM6996LC/LCX/LHX supports four different Ethernet protocols, so the inclusion of auto negotiation ensures that the highest performance protocol will be selected based on the ability of the link partner.

Highest priority is relative to the following list:

- 100Base-TX full duplex (highest priority)
- 100Base-TX half duplex
- 10Base-T full duplex
- 10Base-T half duplex (lowest priority)

3.13 Memory Block

The ADM6996LC/LCX/LHX's built in memory is divided into two blocks. One is a MAC addressing table and the other one is a data buffer.

The MAC address Learning Table size is 2K entries with each entry occupying eight bytes length. These eight bytes of data include a 6 byte source address, VLAN information, Port information and an aging counter.

A data buffer is divided into 256 bytes/block. The ADM6996LC/LCX/LHX buffer management is per port fixed block number and all ports share one global buffer. This architecture can get better memory utilization and network balance at different speeds and duplex test conditions.

Received packets will separate into several 256 bytes/block and chain together. If a packet size is more than 256 bytes then the ADM6996LC/LCX/LHX will chain two or more blocks to store receiving packets.

3.14 Switch Functional Description

The ADM6996LC/LCX/LHX uses a "store & forward" switching approach for the following reason:

- Store & forward switches allow switching between different speed media (e.g. 10BaseX and 100BaseX). Such switches require large elastic buffers especially when bridging between a server on a 100 Mbit/s network and clients on a 10 Mbit/s segment.
- Store & forward switches improve overall network performance by acting as a "network cache"
- Store & forward switches prevent the forwarding of corrupted packets by the frame check sequence (FCS) before forwarding to the destination port.

3.15 Basic Operation

The ADM6996LC/LCX/LHX receives incoming packets from one of its ports, searches in the Address Table for the Destination MAC Address and then forwards the packet to the other port within the same VLAN group, where

appropriate. If the destination address is not found in the address table, the ADM6996LC/LCX/LHX treats the packet as a broadcast packet and forwards the packet to the other ports within the same VLAN group.

The ADM6996LC/LCX/LHX automatically learns the port number of attached network devices by examining the Source MAC Address of all incoming packets at wire speed. If the Source Address is not found in the Address Table, the device adds it to the table.

3.15.1 Address Learning

A four-way hash algorithm is implemented to allow the maximum of 4 different addresses with the same hash key to be stored at the same time. Up to 2K entries can be created and all entries are stored in the internal SSRAM. An address is stored in the Address Table. The ADM6996LC/LCX/LHX searches for the Source Address (SA) of an incoming packet in the Address Table and acts as below:

1. If the SA was not found in the Address Table (a new address), the ADM6996LC/LCX/LHX waits until the end of the packet (non-error packet) and updates the Address Table. If the SA was found in the Address Table, then the aging value of each corresponding entry will be reset to 0_B.
2. When the DA is PAUSE command, then the learning process will be disabled automatically by ADM6996LC/LCX/LHX.

3.15.2 Address Recognition and Packet Forwarding

The ADM6996LC/LCX/LHX forwards the incoming packets between bridged ports according to the Destination Address (DA) as below. All the packet forwarded will check the VLAN first. A forwarding port must be the within the same VLAN as the source port.

If the DA is a UNICAST address and the address was found in the Address Table, the ADM6996LC/LCX/LHX will check the port number and act as follows:

- If the port number is equal to the port on which the packet was received, the packet is discarded.
- If the port number is different, the packet is forwarded across the bridge.
- If the DA is a UNICAST address and the address was not found, the ADM6996LC/LCX/LHX treats it as a multicast packet and forwards it across the bridge.
- If the DA is a Multicast address, the packet is forwarded across the bridge.
- If the DA is a PAUSE Command (01 80 C2 00 00 01_H), then this packet will be dropped by the ADM6996LC/LCX/LHX. The ADM6996LC/LCX/LHX can issue and learn PAUSE commands.
- The ADM6996LC/LCX/LHX will forward the packet with a DA of (01 80 C2 00 00 00_H), filter out the packet with a DA of (01 80 C2 00 00 01_H), and forward a packet with a DA of (01-80-C2-00-00-02_H to 01 80 C2 00 00 0F_H)

3.15.3 Address Aging

Address aging is supported for topology changes such as an address moving from one port to another. When this happens, the ADM6996LC/LCX/LHX internally has a 300 second timer which will “age-out” (remove) the address from the address table. The aging function can be enabled/disabled by the user. Normally, disabling an aging function is for security purposes.

3.15.4 Back off Algorithm

The ADM6996LC/LCX/LHX implements the truncated exponential back off algorithm compliant to the 802.3 CSMA-CD standard. The ADM6996LC/LCX/LHX will restart the back off algorithm by choosing 0-9 collision counts. The ADM6996LC/LCX/LHX resets the collision counter after 16 consecutive retransmit trials.

3.15.5 Inter-Packet Gap (IPG)

IPG is the idle time between any two successive packets from the same port. The typical number is 96 bits at a time. The value is 9.6 micro secs for 10 Mbit/s Ethernet, 960ns for 100 Mbit/s fast Ethernet and 96ns for 1000M.

The ADM6996LC/LCX/LHX provides an option of 92 bit gap in an EEPROM to prevent packet loss when Flow Control is turned off and clock P.P.M. values differ.

3.15.6 Illegal Frames

The ADM6996LC/LCX/LHX will discard all illegal frames such as runt packets (less than 64 bytes), oversized packets (greater than 1518 or 1522 bytes) and bad CRC. Dribbling packing with good CRC value will be accepted by the ADM6996LC/LCX/LHX. In case of bypass mode enable, the ADM6996LC/LCX/LHX will support tag and untagged packets with sizes up to 1522 bytes. In case of non-bypass mode, the ADM6996LC/LCX/LHX will support tag packets up to 1526bytes and untagged packets up to 1522bytes.

3.15.7 Half Duplex Flow Control

A back pressure function is supported for half-duplex operations. When the ADM6996LC/LCX/LHX cannot allocate a receive buffer for an incoming packet (buffer full), the device will transmit a jam pattern on the port, thus forcing a collision. Back Pressure is enabled by the BPEN set during RESET assertion. An Infineon proprietary algorithm is implemented inside the ADM6996LC/LCX/LHX to prevent the back pressure function causing HUB partitioned under heavy traffic environment and reducing the packet loss rate to increase the whole system performance.

3.15.8 Full Duplex Flow Control

When full duplex port run out of its receive buffer, a PAUSE packet command will be issued by ADM6996LC/LCX/LHX to notice the packet sender to pause transmission. This frame based flow control is totally compliant to IEEE 802.3x. ADM6996LC/LCX/LHX can issue or receive pause packet.

3.15.9 Old Broadcast Storm filter (0x0b[0]=0 and 0x11[6]=0)

If the Broadcast Storm filter is enabled, the broadcast packets over 50 ms of the threshold will be discarded by the threshold setting. See EEPROM Reg.10_H.

Broadcast storm mode:

Time interval: 50ms

Max. packet number = 7490 in 100Base, 749 in 10Base

Table 4 The max. packet number = 7490 in 100Base, 749 in 10Base

Per Port Falling Threshold				
	00 _B	01 _B	10 _B	11 _B
All 100TX	Disable	7440fps	14880fps	29760fps
Not All 100TX	Disable	744fps	1488fps	2976fps

Table 5 The max. packet number = 7490 in 100Base, 749 in 10Base

Per Port Rising Threshold				
	00 _B	01 _B	10 _B	11 _B
All 100TX	Disable	14880fps	29760fps	59520fps
Not All 100TX	Disable	1488fps	2976fps	5952fps

3.15.10 New Broadcast/Multicast Storm (0x0b[0]=1 and 0x11[6]=1)

ADM6996LC/LCX allows users to limit the traffic of the broadcast address (DA = FFFFFFFF_H) to prevent them from blocking the switch bandwidth. If users also want to limit the multicast packets(DA[40] = 1_B), they can

set the Multicast Packet Counted into Storming Counter (see 0010_H[5]) function. Two thresholds and storm enable bits (see 003B_H and 003C_H) are used to control the broadcast storm.

1. Time Scale. ADM6996LC/LCX uses 50ms as a scale to meter the storm packets.

Parameter	Rising Threshold	Falling Threshold
All link ports are 100M	100M Threshold (See 003B _H [12:0])	1/2 100M Threshold
All link ports are not all 100M	10M Threshold (See 003C _H [12:0])	1/2 10M Threshold

2. Storm keeps on at least 1.6 seconds if any of the ports meets the rising threshold in the 4 consecutive 50 ms intervals. In these 1.6 seconds, the ports meeting the rising threshold will start to discard the broadcast or multicast packets until the 50 ms interval expires. Users could also disable Input Filter (see 000B_H[14]) function to forward above packets to the un-congested port instead of discarding directly.

3. Storm finishes. After the 1.6-second storm period, ADM6996LC/LCX will check the port that makes the storm on. If all of these ports meet the falling threshold in the 2 consecutive 50 ms intervals and no other ports satisfy the rising threshold at the same time, the storm will finish.

3.16 Auto TP MDIX function

At normal application which Switch connect to NIC card is by one by one TP cable. If Switch connect other device such as another Switch must by two way. First one is Cross Over TP cable. Second way is use extra RJ45 which crossover internal TX+ and RX+ signal. By second way customer can use one by one cable to connect two Switch devices. All these effort need extra cost and not good solution. ADM6996LC/LCX/LHX provide Auto MDIX function which can adjust TX+ and RX+ at correct pin. User can use one by one cable between ADM6996LC/LCX/LHX and other device. This function can be Enable/Disable by hardware pin and EEPROM configuration register 01_H ~ 09_H bit 15. If hardware pin set all port at Auto MDIX mode then EEPROM setting is useless. If hardware pin set all port at non Auto MDIX mode then EEPROM can set each port this function enable or disable.

3.17 Port Locking

Port locking function will provide customer simple way to limit per port user number to one. If this function is turn on then ADM6996LC/LCX/LHX will lock first MAC address in learning table. After this MAC address locking will never age out except Reset signal. Another MAC address which not same as locking one will be dropped. ADM6996LC/LCX/LHX provide one MAC address per port. This function is per port setting. When turn on Port Locking function, recommend customer turn off aging function. See EEPROM register 12_H bit 0~8.

3.18 VLAN setting & Tag/Untag & port-base VLAN

ADM6996LC/LCX/LHX supports bypass mode and untagged port as default setting while the chip is power-on. Thus, every packet with or without tag will be forwarded to the destination port without any modification by ADM6996LC/LCX/LHX. Meanwhile port-base VLAN could be enabled according to the PVID value (user define 4bits to map 16 groups written at register 13_H to register 22_H) of the configuration content of each port.

ADM6996LC/LCX/LHX also supports 16 802.1Q VLAN groups. In VLAN four bytes tag include twelve VLAN ID. ADM6996LC/LCX/LHX learn user define four bits of VID. If user need to use this function, two EEPROM registers are needed to be programmed first:

* Port VID number at EEPROM register 01_H ~ 09_H bit 13~10, register 28_H ~ 2B_H and register 2C_H bit 7~0: ADM6996LC/LCX/LHX will check coming packet. If coming packet is non VLAN packet then ADM6996LC/LCX/LHX will use PVID as VLAN group reference. ADM6996LC/LCX/LHX will use packet's VLAN value when receive tagged packet.

* VLAN Group Mapping Register. EEPROM register 13_H ~ 22_H define VLAN grouping value. User use these register to define VLAN group.

User can define each port as Tag port or Untag port by Configuration register Bit 4. The operation of packet between Tag port and Untag port can explain by follow example:

Example1: Port receives Untag packet and send to Untag port.

ADM6996LC/LCX/LHX will check the port user define four bits of VLAN ID first then check VLAN group resister. If destination port same VLAN as receiving port then this packet will forward to destination port without any change. If destination port not same VLAN as receiving port then this packet will be dropped.

Example2: Port receives Untag packet and send to Tag port.

ADM6996LC/LCX/LHX will check the port user define fours bits of VLAN ID first then check VLAN group resister. If destination port same VLAN as receiving port than this packet will forward to destination port with four byte VLAN Tag and new CRC. If destination port not same VLAN as receiving port then this packet will be dropped.

Example3: Port receives Tag packet and send to Untag port.

ADM6996LC/LCX/LHX will check the packet VLAN ID first then check VLAN group resister. If destination port same VLAN as receiving port than this packet will forward to destination port after remove four bytes with new CRC error. If destination port not same VLAN as receiving port then this packet will be dropped.

Example4: Port receives Tag packet and send to Tag port.

ADM6996LC/LCX/LHX will check the user define packet VLAN ID first then check VLAN group resister. If destination port same VLAN as receiving port than this packet will forward to destination port without any change. If destination port not same VLAN as receiving port then this packet will be dropped.

3.19 Old Fixed Ingress Bandwidth Control (0x0b[0]=0)

ADM6996LC/LCX/LHX also supports ADM6996L compatible Bandwidth Control with fixed rate.

Table 6 Fixed Ingress Bandwidth Control

000	001	010	011	100	101	110	111
256K	512k	1M	2M	5M	10M	20M	50M

3.20 New Scalable Egress/Ingress Bandwidth Control (0x0b[0]=1 and 0x33[12]=1)

Bandwidth control function is useful on community networks for different levels of service. ADM6996LC/LCX/LHX provides Scalable Egress/Ingress Bandwidth Control. Users can set any value that is based on a 64K unit.

3.21 MAC Table Accessible

CPU accesses Switch internal MAC table is provided by ADM6996LC/LCX/LHX. CPU can Search, Add, Delete and Set ADM6996LC/LCX/LHX internal MAC table through a serial interface.

Search: CPU can search target MAC address Switch port number.

Add: CPU can add MAC address to learning table.

Delete: CPU can delete MAC address from learning table.

Set MAC Address: CPU can set MAC address as Static or no Static address. Static means not aging out.

3.22 Priority Setting

It is a trend that data, voice and video will be put on networking, Switch not only deal data packet but also provide service of multimedia data. ADM6996LC/LCX/LHX provides two priority queues on each port with N:1 rate. See EEPROM Reg.10_H.

This priority function can set three ways as below:

* By Port Base: Set specific port at specific queue. ADM6996LC/LCX/LHX only check the port priority and not check packet's content VLAN and TOS.

- * By VLAN first: ADM6996LC/LCX/LHX check VLAN three priority bit first then IP TOS priority bits.
 - * By IP TOS first: ADM6996LC/LCX/LHX check IP TOS three priority bit first then VLAN three priority bits.
- If port set at VLAN/TOS priority but receiving packet without VLAN or TOS information then port base priority will be used.
- * By TCP/UDP Destination Port Number: ADM6996LC/LCX/LHX check Layer4 TCP/UDP Destination Port number to map the priority queue.
 - * By MAC Destination Address: User can set MAC address to map priority queue.

3.23 LED Display

Three LEDs per port are provided by ADM6996LC/LCX/LHX. Link/Act, Duplex/Col. & Speed are three LED display of ADM6996LC/LCX/LHX. Dual color LED mode also supported by ADM6996LC/LCX/LHX. For easy production purpose ADM6996LC/LCX/LHX will send test signal to each LED at power on reset stage. EEPROM register 12_H define LED configuration table.

1. **LED_MODE**: It is the value latched on the EDI pin during the power on reset. It's also used to control the dual or single color mode and is useless when the value wait_init is high.
2. **DCS** (see 0012_H): Dupcol LEDs indicate the duplex status only.
3. **DHCOL** (See 0030_H): When enabled, pin DUPCOL0 shows col_10m status and pin DUPCOL1 shows col_100m status. These two LEDs are necessary in the dual-speed hub.

ADM6996LC/LCX/LHX LED is active Low signal. Dupcol0 & Dupcol1 will check external signal at Reset time. If external signal add pull high then LED will active Low. If external signal add pull down resistor then LED will drive high.

3.23.1 Single Color LED Display

Table 7 Single Color LED Display

Pin Name	Status
LNKACT4/LNKACT3/ LNKACT2/LNKACT1/ LNKACT0	<p>These pins have no power on reset values on them, and ADM6996LC/LCX/LHX uses active low value to drive the led. So the output values of these pins after the power on reset are shown as follows:</p> <ol style="list-style-type: none"> 1. First period: This period lasts 1.28 s for LED on test. ADM6996LC/LCX/LHX drives value 0 to open the LED. 2. Second period: This period lasts 0.48 s for LED off test. ADM6996LC/LCX/LHX drives value 1 to close the LED. 3. Normal Period: This period indicates the link status. <ul style="list-style-type: none"> 0_B Port links up and LED is ON. 1_B Port links down and LED is OFF. 0/1_B Port links up and is transmitting or receiving. The LED flashes at 10 Hz.
LDSPD4/LDSPD3/ LDSPD2/LDSPD1/ LDSPD0	<p>The behavior of these pins is the same as the LNKACT, except the normal period.</p> <p>Normal period: This period indicates the speed status.</p> <ul style="list-style-type: none"> 0_B Port links up and its speed is 100M. LED is ON. 1_B Port links down or its speed is 10M. LED is OFF.

Table 7 **Single Color LED Display (cont'd)**

Pin Name	Status
DUPCOL2/ DUPCOL1/ DUPCOL0	<p>These 3 pins have power on reset values on them. ADM6996LC/LCX/LHX needs to consider these values to drive the correct value. If the power on reset value is value_power_on, then the display is as follows:</p> <ol style="list-style-type: none"> 1. First period: This period lasts 1.28 s for LED on test. ADM6996LC/LCX/LHX drives ~value_power_on to open the LED. 2. Second period: This period lasts 0.48 s for LED off test. ADM6996LC/LCX/LHX drives value_power_on to close the LED. 3. Normal Period: This period indicates the duplex/collision status. <ul style="list-style-type: none"> ~value_power_on = Port links up in the full-duplex mode. LED is ON. value_power_on = Port links down. LED flashes at 10 Hz. 0/1_B Port links up and collision is detected. The LED flashes at 10 Hz. <p>If DCS is enabled, the normal period changes its way to display.</p> <ul style="list-style-type: none"> ~value_power_on = Port links up in the duplex mode. LED is ON. value_power_on = Port links down or links up in the half-duplex mode. LED is OFF. 0/1_B This value is cancelled. LED doesn't blink. <p>If DHCOL is enabled, the display in the normal period is as follows:</p> <p>DUPCOL0: 10m collision indicator.</p> <p>0/1_B One of the ports links up in 10M half-duplex mode and detects a collision event. The LED flashes at 20 Hz.</p> <p>value_power_on = When the above event is not satisfied, the LED is OFF.</p> <p>DUPCOL1: 100 m collision indicator.</p> <p>0/1_B One of the ports links up in 100M half-duplex mode and detects a collision event. The LED flashes at 20 Hz.</p> <p>value_power_on = The above event is not satisfied. LED is OFF.</p>
DUPCOL4/ DUPCOL3	<p>The behavior of these pins is the same as the LNKACT, except for the normal period.</p> <p>Normal period: This period indicates the duplex/collision status.</p> <ul style="list-style-type: none"> ~value_power_on = Port links up in the full-duplex mode. LED is ON. value_power_on = Port links down. LED is OFF. 0/1_B Port links up and collision is detected. The LED flashes at 10 Hz. <p>If DCS is enabled, the normal period changes its way to display.</p> <ul style="list-style-type: none"> ~value_power_on = Port links up in the duplex mode. LED is ON. value_power_on = Port links down or links up in the half-duplex mode. LED is OFF. 0/1_B This value is cancelled. LED doesn't blink.

3.23.2 Dual Color LED Display

Users should be careful that DUPCOL LED only supports the single color mode. The only difference between single and dual color for DUPCOL LED is the self-test time.

Table 8 Dual Color LED Display

Pin Name	Status
(LNKACT4, LDSPD4)/ (LNKACT3, LDSPD3) (LNKACT2, LDSPD2) (LNKACT1, LDSPD1) (LNKACT0, LDSPD0)	<p>First Period: Test LED on with green color. It lasts 1.28 s. 01_B LED is on with green color.</p> <p>Second Period: Test LED on with yellow color. It lasts 1.28 s. 10_B LED is on with yellow color.</p> <p>Third period: Test LED off. 00_B LED is off.</p> <p>Normal Period: This period shows the status of the link and speed at the same time.</p> <p>00_B Port links down. LED is off. 11_B Port links down. LED is off. 01_B Port links up in 100M. LED glows green. 10_B Port links up in 10M. LED glows yellow. 0/1,1_B Port links up in 100M and is receiving or transmitting. LED blinks with green color at 10 Hz. 0/1,0_B Port links up in 10M and is receiving or transmitting. LED blinks with yellow color at 10 Hz.</p>
DUPCOL4/DUPCOL3/ DUPCOL2/DUPCOL1/ DUPCOL0	The behavior of these pins is the same as the single mode, except the self-test period. The LED on test period is 2.56 s instead of 1.28 s.

3.23.3 Circuit for Single LED Mode

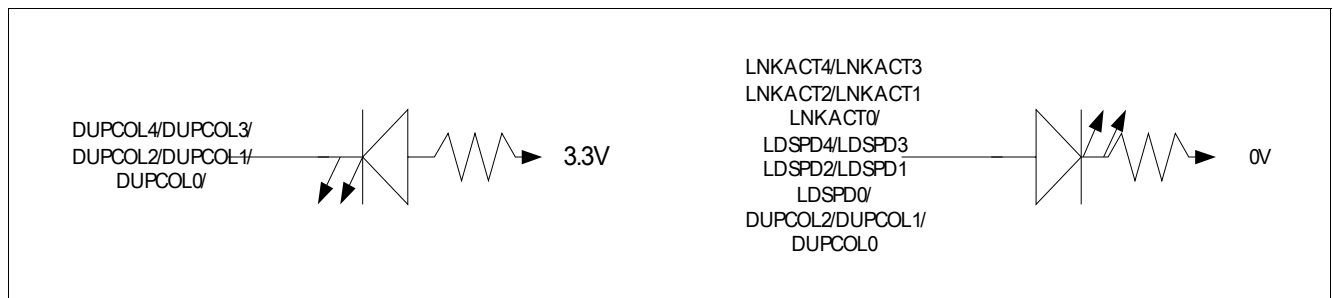

Figure 3 Circuit for Single Color LED Mode

3.23.4 Circuit for Dual Led Mode

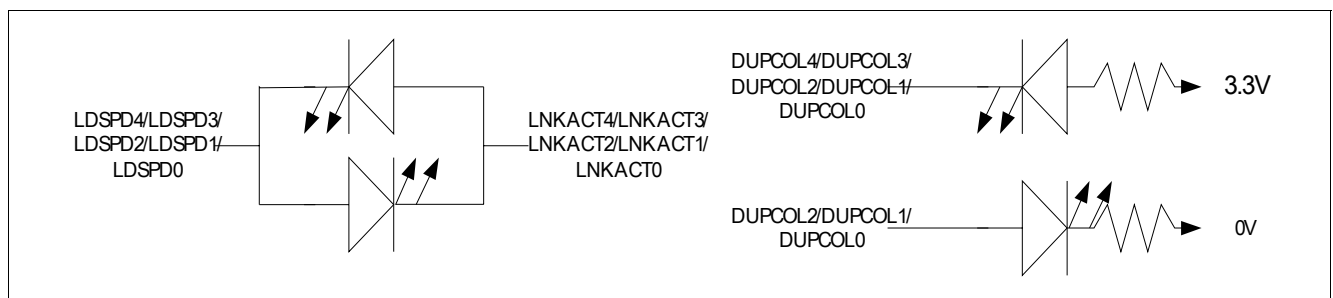

Figure 4 Circuit for Dual Color LED Mode

3.24 MAC Clone and Port5 MII connection

In ADM6996LC/LCX, there are three different configurations (MAC type MII mode, GPSI mode and RMII, **P5_BUSMDO**) for Port5 to connect the CPU's MII/GPSI or RMII interface.

Here we depicted a general router applications of ADM6996LC/LCX, connected to CPU with single MII. In **Figure 5**, we can see either LAN to WAN or WAN to LAN, the packets will go through the same MII port. Because the CPU need to send out the packets with the registered MAC ID to the WAN port, and this MAC ID may also come in from the LAN ports. We know the switch learning scheme can't permit the packets with same MAC ID input from different port. In the ADM6996LC/LCX design, we use the MAC clone and VLAN group to solve this problem. From **Figure 6**, users can have more details for this implementation.

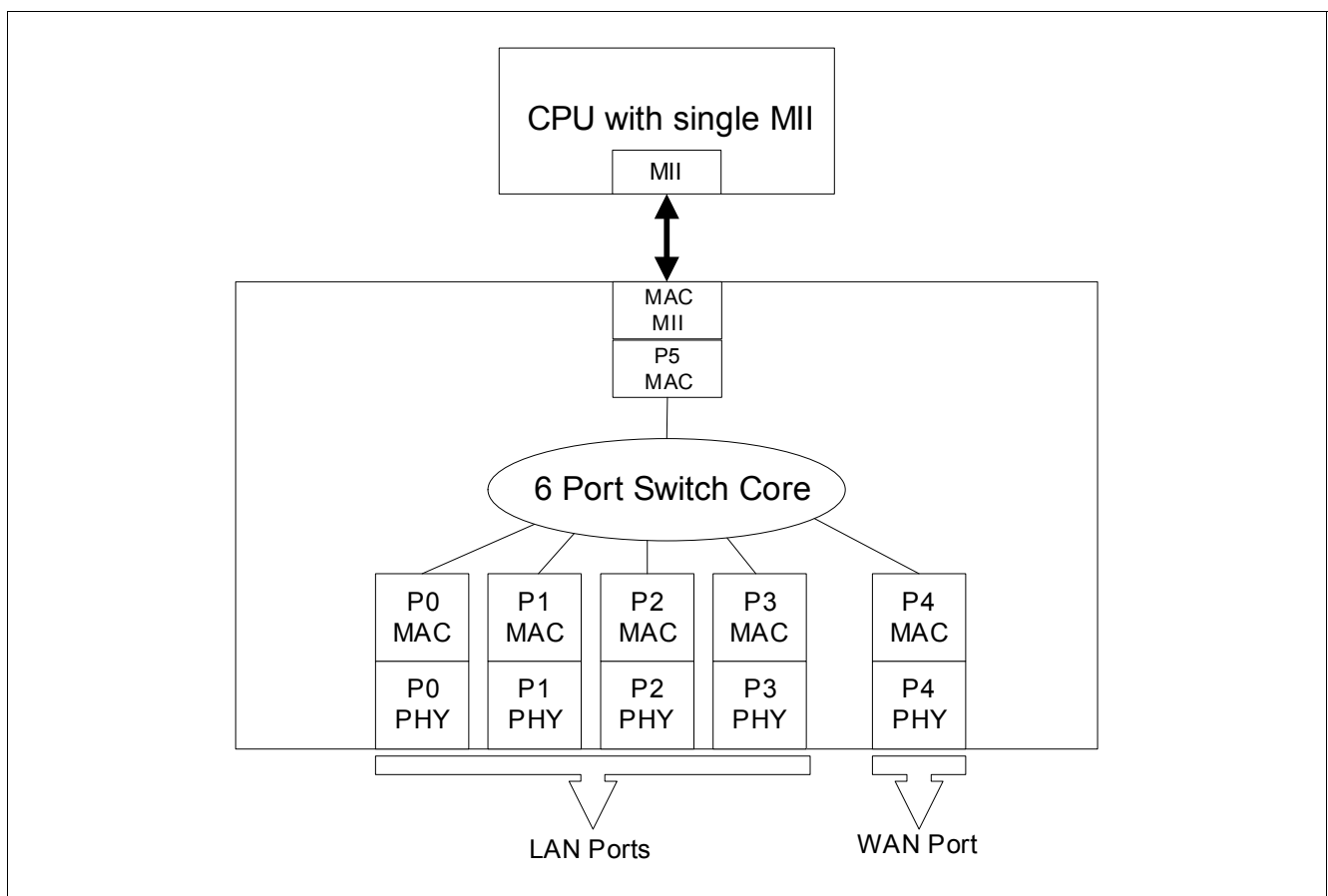

Figure 5 ADM6996LC/LCX to CPU with single MII Connection

Here we use an example to describe how to enable the MAC clone and set the VLAN group to reach this LAN/WAN routing activity.

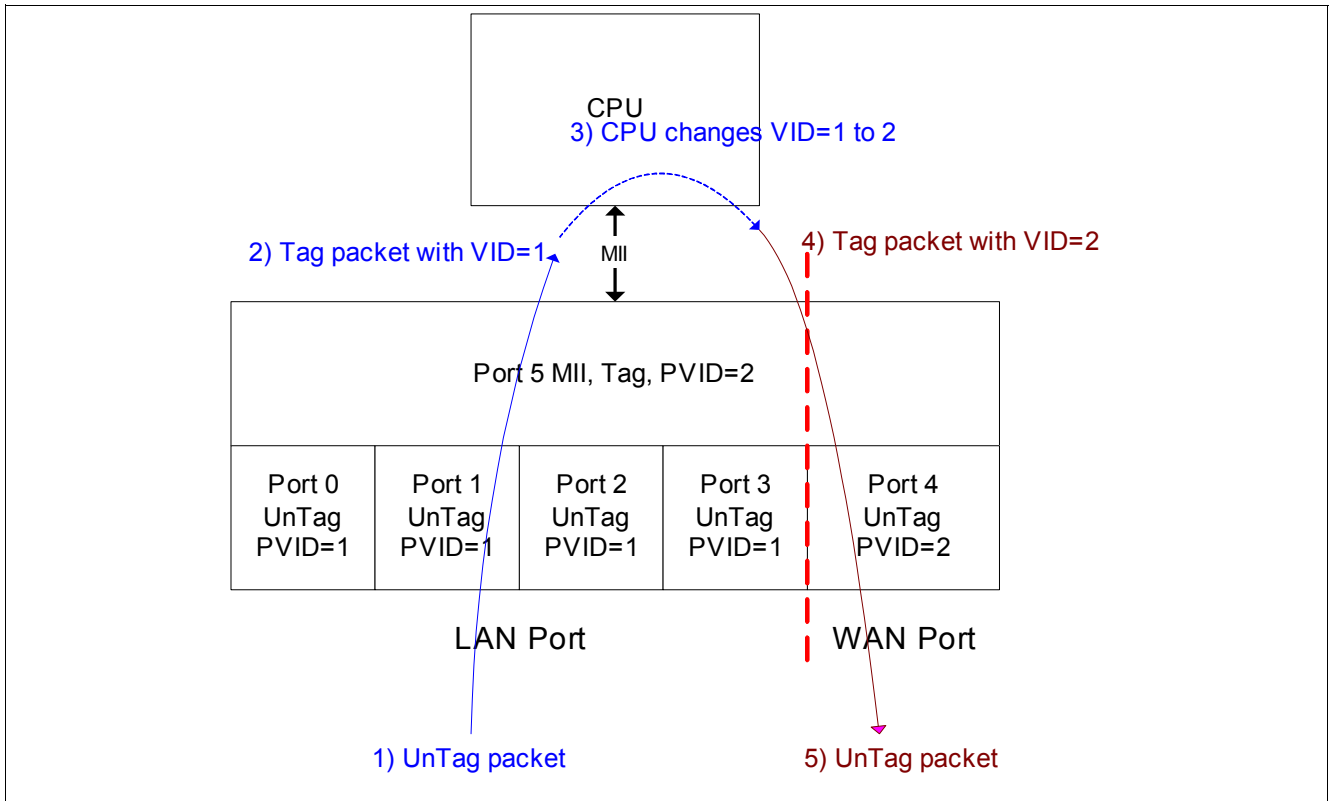

Figure 6 MAC Clone Enable and VLAN Setting

Step1: Set ADM6996LC/LCX to tag-based VLAN mode -- set EEPROM 0x11_H to 0xff20_H

Step2: Set per port PVID and Tag/UnTag output port --

Port0, UnTag, PVID=1, set EEPROM 0x01_H to 0x840f_H

Port1, UnTag, PVID=1, set EEPROM 0x03_H to 0x840f_H

Port2, UnTag, PVID=1, set EEPROM 0x05_H to 0x840f_H

Port3, UnTag, PVID=1, set EEPROM 0x07_H to 0x840f_H

Port4, UnTag, PVID=2, set EEPROM 0x08_H to 0x880f_H

Port5, Tag, PVID=2, set EEPROM 0x09_H to 0x881f_H

Step3: Set WAN/LAN group

Group1: Port 0/1/2/3/5, set EEPROM 0x14_H to 0x0155_H

Group2: Port 4/5, set EEPROM 0x15_H to 0x0180_H

If Untag packet received from LAN port and forwards to CPU port, ADM6996LC/LCX will use ingress port PVID as the egress tag VID. CPU can recognize the source group of the packet by VID. If VID=1, it means the packet is received from the LAN port. Otherwise, if VID=2, it means the packet is received from the WAN port.

CPU has to change the tag VID to determine the destination group. The tag packet received from CPU port will follow tag-based VLAN to determine the broadcast domain. If the tag packet with VID=1 will follow VLAN group 1 (LAN group) and the tag packet with VID=2 will follow the VLAN group 2 (WAN group).

Normally, the MAC mode MII should be connected to the PCS mode MII. But in some applications, we need to connect both MAC mode MII to each other as shown in above figures. In **Figure 7**, due to most CPU's MII being MAC mode, so Port5 is MAC to MAC connected.

Through the hardware setting, it is easy to set ADM6996LC/LCX Port5 MII to operate in 100M Full Duplex mode. This mode (100M Full) is normally the operation mode to be with CPU, the interface connection is described in the following diagram.

(1) CKO25M is the 25M clock driven out by ADM6996LC/LCX to fit 100M MII operation. This clock output provides 8mA driving capability and it can directly connected to TXCLK/RXCLK.

(2) Due to it is operated in Full duplex mode, so COL is tied to GND.

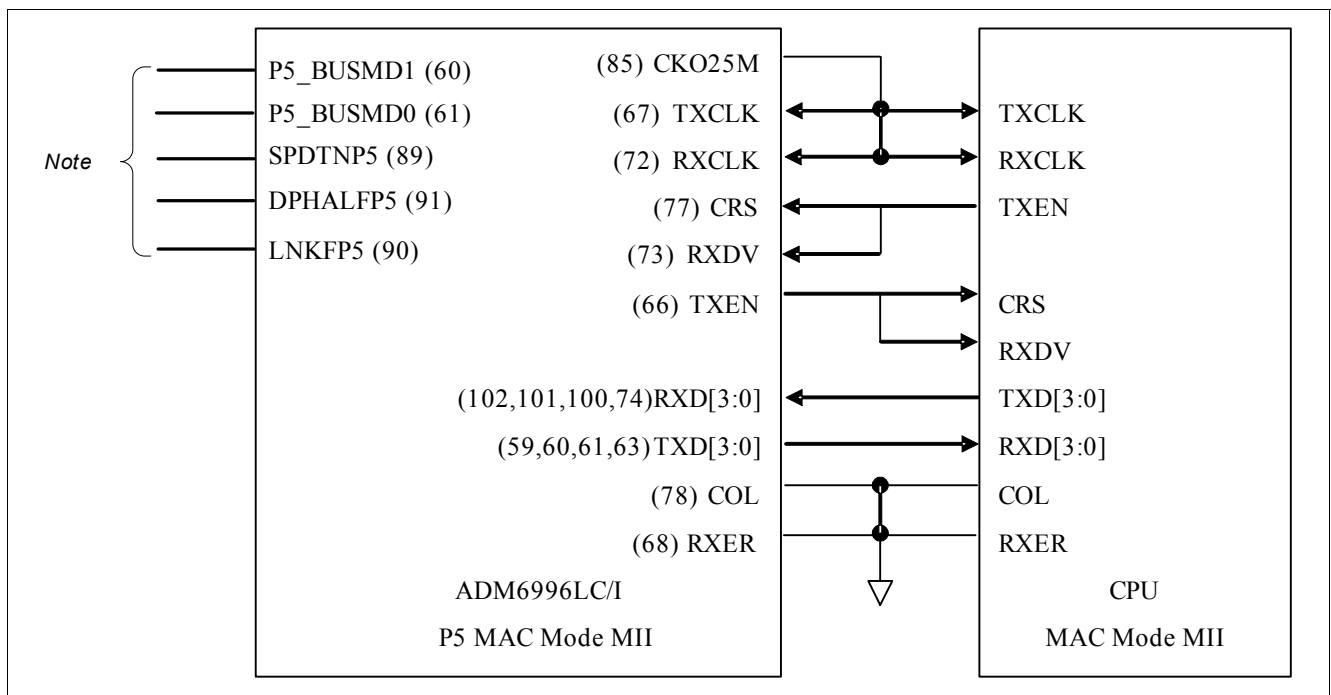

Figure 7 100M Full duplex MAC to MAC MII Connection

Note:

1. Pin 60 and pin 61 should be pull low to let P5_BUSMD be latched as "00" and make Port5 be operating in MII mode (**P5_BUSMD0**).
2. Pin 89 (SPDTNP5) should be pull low or floating to set Port5 be operating in 100Mbit/s.
3. Pin 91 (DPHALFP5) should be pull low or floating to set Port5 be operating in full duplex mode.
4. Pin 90 (LNKFP5) should be pull low or floating to set Port5 Link up.

3.25 The Hardware Difference between ADM6996LC/LCX/I and ADM6996L

ADM6996LC/LCX is power-down version to replace ADM6996L and ADM6996I is advanced function version to new application.

Pin Description(QFP128)

Table 9 Pin Description(QFP128)

Pin No.	ADM6996LC/LCX	ADM6996L	Notes
47	GNDIK(GND Digital)	NC	GNDIK in ADM6996L datasheetAsk the customer to double-check
48	VCCIK(1.8V Digital)	NC	VCCIK in ADM6996L datasheetAsk the customer to double-check
59	P5TXD3(SDIO_MD)	P5TXD3(VOL23)	For ADM6996LC/LCX, SDIO_MD=0 default 32bit modeFor ADM6996I, SDIO_MD=0 default 16bit modeAdd pull-up/down resistor for ADM6996L/LC/I compatible design to avoid wrong power-on-latch.
60	P5TXD2(RMIISEL)	P5TXD2(ROMCODE25)	Add pull down resistor for ADM6996L/LC/I P5 MII mode to avoid wrong power-on-latch.
61	P5TXD1(7WIRE)	P5TXD1(P5GPSI)	Add pull down resistor for ADM6996L/LC/I P5 MII mode to avoid wrong power-on-latch.
65	INT_N	VCCIK(1.8V Digital)	Interrupt for Learning Table Access/Port Security/Counter Overflow/Port StatusAdd a option design to CPU INT_N pin

4 32 Bits Mode Registers Description

4.1 EEPROM Registers (0x0b[0]=0)

Table 10 Registers Address Space

Module	Base Address	End Address	Note
EEPROM	00 _H	33 _H	Independent Address Space

Table 11 Registers Overview

Register Short Name	Register Long Name	Offset Address	Page Number
SigReg	Signature Register	00 _H	43
CtrlReg_0	Basic Control Register 0	01 _H	44
ResReg_0	Reserved Register 0	02 _H	45
CtrlReg_P1	Basic Control Register 1	03 _H	45
ResReg_1	Reserved Register 1	04 _H	45
CtrlReg_P2	Basic Control Register 2	05 _H	45
ResReg_2	Reserved Register 2	06 _H	45
CtrlReg_P3	Basic Control Register 3	07 _H	45
CtrlReg_P4	Basic Control Register 4	08 _H	45
ResReg_3	Reserved Register 3	09 _H	45
ResReg_4	Reserved Register 4	0A _H	46
ConfigReg_1	Configuration Register 1	0B _H	46
ResReg_5	Reserved Register 5	0C _H	46
ResReg_6	Reserved Register 6	0D _H	47
VLAN_Map_P	VLAN priority Map Register	0E _H	47
TOS_Priority	TOS priority Map Register	0F _H	48
ConfigReg_2	Configuration Register 2	10 _H	48
VLAN_Mode	VLAN Mode Select Register	11 _H	49
ConfigReg_3	Miscellaneous Configuration Register 3	12 _H	52
VLAN_Map_0	VLAN mapping table registers 0	13 _H	53
VLAN_Map_1	VLAN mapping table registers 1	14 _H	54
VLAN_Map_2	VLAN mapping table registers 2	15 _H	54
VLAN_Map_3	VLAN mapping table registers 3	16 _H	54
VLAN_Map_4	VLAN mapping table registers 4	17 _H	54
VLAN_Map_5	VLAN mapping table registers 5	18 _H	54
VLAN_Map_6	VLAN mapping table registers 6	19 _H	54
VLAN_Map_7	VLAN mapping table registers 7	1A _H	54
VLAN_Map_8	VLAN mapping table registers 8	1B _H	54
VLAN_Map_9	VLAN mapping table registers 9	1C _H	54
VLAN_Map_10	VLAN mapping table registers 10	1D _H	54

32 Bits Mode Registers Description

Table 11 Registers Overview (cont'd)

Register Short Name	Register Long Name	Offset Address	Page Number
VLAN_Map_11	VLAN mapping table registers 11	1E _H	54
VLAN_Map_12	VLAN mapping table registers 12	1F _H	54
VLAN_Map_13	VLAN mapping table registers 13	20 _H	54
VLAN_Map_14	VLAN mapping table registers 14	21 _H	54
VLAN_Map_15	VLAN mapping table registers 15	22 _H	54
ResReg_7	Reserved Register 7	23 _H	54
ResReg_8	Reserved Register 8	24 _H	55
ResReg_9	Reserved Register 9	25 _H	55
ResReg_10	Reserved Register 10	26 _H	55
ResReg_11	Reserved Register 11	27 _H	55
ConfigReg_4	Configuration Register 4	28 _H	55
ConfigReg_5	Configuration Register 5	29 _H	55
ConfigReg_6	Configuration Register 6	2A _H	56
ConfigReg_7	Configuration Register 7	2B _H	56
ConfigReg_8	Configuration Register	2C _H	56
ResReg_12	Reserved Register 12	2D _H	57
ResReg_13	Reserved Register 13	2E _H	58
PH_Restart	PHY Restart	2F _H	58
ConfigReg_9	Miscellaneous Configuration Register 9	30 _H	59
BWCon_0	Bandwidth Control Register 0	31 _H	59
BWCon_1	Bandwidth Control Register 1	32 _H	60
BWConEn	Bandwidth Control Enable Register	33 _H	61

The register is addressed wordwise.

Table 12 Register Access Types

Mode	Symbol	Description HW	Description SW
read/write	rw	Register is used as input for the HW	Register is read and writable by SW
read	r	Register is written by HW (register between input and output -> one cycle delay)	Value written by software is ignored by hardware; that is, software may write any value to this field without affecting hardware behavior (= Target for development.)
Read only	ro	Register is set by HW (register between input and output -> one cycle delay)	SW can only read this register
Read virtual	rv	Physically, there is no new register, the input of the signal is connected directly to the address multiplexer.	SW can only read this register
Latch high, self clearing	lhsc	Latch high signal at high level, clear on read	SW can read the register
Latch low, self clearing	llsc	Latch high signal at low-level, clear on read	SW can read the register
Latch high, mask clearing	lhmk	Latch high signal at high level, register cleared with written mask	SW can read the register, with write mask the register can be cleared (1 clears)

32 Bits Mode Registers Description

Table 12 Register Access Types (cont'd)

Mode	Symbol	Description HW	Description SW
Latch low, mask clearing	llmk	Latch high signal at low-level, register cleared on read	SW can read the register, with write mask the register can be cleared (1 clears)
Interrupt high, self clearing	ihsc	Differentiate the input signal (low->high) register cleared on read	SW can read the register
Interrupt low, self clearing	ilsc	Differentiate the input signal (high->low) register cleared on read	SW can read the register
Interrupt high, mask clearing	ihmk	Differentiate the input signal (high->low) register cleared with written mask	SW can read the register, with write mask the register can be cleared
Interrupt low, mask clearing	ilmk	Differentiate the input signal (low->high) register cleared with written mask	SW can read the register, with write mask the register can be cleared
Interrupt enable register	ien	Enables the interrupt source for interrupt generation	SW can read and write this register
latch_on_reset	lor	rw register, value is latched after first clock cycle after reset	Register is read and writable by SW
Read/write self clearing	rwsc	Register is used as input for the hw, the register will be cleared due to a HW mechanism.	Writing to the register generates a strobe signal for the HW (1 pdi clock cycle) Register is read and writable by SW.

Table 13 Registers Clock Domains

Clock Short Name	Description
–	–

4.1.1 EEPROM Register Descriptions

Signature Register

Description

SigReg **Offset**
Signature Register **00_H** **Reset Value**
4154_H

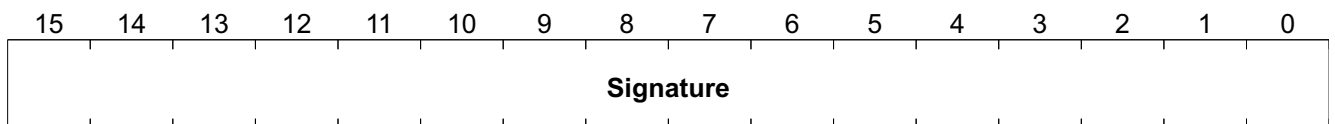

ro

Field	Bits	Type	Description
Signature	15:0	ro	Signature 4154 _H SigReg Obligatory value (AT)

32 Bits Mode Registers Description

Note: ADM6996LC/LCX/LHX will check register 0 value before read all EEPROM content. If this value not match with 0x4154h then other values in EEPROM will be useless. ADM6996LC/LCX/LHX will use internal default value. User cannot write Signature register when programming ADM6996LC/LCX/LHX internal register.

Basic Control Register 0

Used to configure chip settings

CtrlReg_0 **Offset**
Basic Control Register 0 **01_H** **Reset Value**
040F_H

15	14	13	12	11	10	9	8	7	6	5	4	3	2	1	0
CAM	FSE		PV			PP	PPE	TV	PD	OT	DUP	OPS	AN	FC	
rw	rw		rw			rw	rw	rw	rw	rw	rw	rw	rw	rw	rw

Field	Bits	Type	Description
CAM	15	rw	Crossover Auto MDIX 0 _B D Disable <i>Note: Hardware Reset latch value EESK can be set globally using the Auto MDIX function.</i> 1 _B E Enable
FSE	14	rw	Fx Select Enable 0 _B TP Tp Mode <i>Note: If this bit has been set to Fx in hardware then the bit does not have the power to change from Fx to Tp</i> 1 _B FX Fx Mode
PV	13 :10	rw	Port VLAN ID
PP	9:8	rw	Port Based Priority
PPE	7	rw	Port Based Priority Enable 0 _B VTE VLAN or TOS Priority Enable <i>Note: This bit is default 0_B to enable VLAN or TOS priority check. If user would like to check the VLAN priority, Tag mode should be enabled.</i> 1 _B PBE Port Based Priority Enable <i>Note: If this bit is set to 1_B, only port based priority will be checked.</i>
TV	6	rw	TOS over VLAN priority 0 _B V VLAN Enable 1 _B T TOS Enable
PD	5	rw	Port Disable 0 _B E Enable 1 _B D Disable
OT	4	rw	Output Packet Tagging 0 _B U Un-tag 1 _B T Tag

32 Bits Mode Registers Description

Field	Bits	Type	Description
DUP	3	rw	Duplex Enable 0 _B H Half 1 _B F Full
OPS	2	rw	Operating Speed 0 _B 10 10 Mbit/s 1 _B 100 100 Mbit/s
AN	1	rw	Auto-negotiation 0 _B D Disable 1 _B E Enable
FC	0	rw	802.x Flow Control Command 0 _B D Disable 1 _B E Enable

Similar Registers

Table 14 Basic Control Registers 1 to 4

Register Short Name	Register Long Name	Offset Address	Page Number
CtrlReg_P1	Basic Control Register 1	03 _H	
CtrlReg_P2	Basic Control Register 2	05 _H	
CtrlReg_P3	Basic Control Register 3	07 _H	
CtrlReg_P4	Basic Control Register 4	08 _H	

Reserved Register 0

Register reserved for future use

ResReg_0	Offset	Reset Value
Reserved Register 0	02_H	040F_H

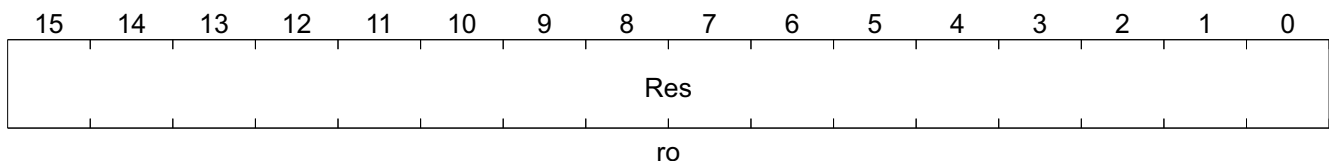

Field	Bits	Type	Description
Res	15:0	ro	Reserved

Similar Registers

Table 15 Reserved Register 1 to 3

Register Short Name	Register Long Name	Offset Address	Page Number
ResReg_1	Reserved Register 1	04 _H	
ResReg_2	Reserved Register 2	06 _H	
ResReg_3	Reserved Register 3	09 _H	

32 Bits Mode Registers Description

Reserved Register 4

Register reserved for future use

ResReg_4 **Offset**
Reserved Register 4 **0A_H** **Reset Value**
5902_H

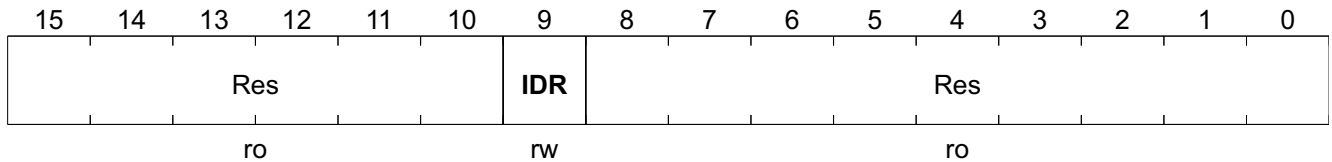

Field	Bits	Type	Description
Res	15:10	ro	Reserved
IDR	9	rw	Replace Packet ID 0 _B N Not replaced 1 _B Y Replaced with 1 by PVID
Res	8:0	ro	Reserved

Configuration Register 1

Used to configure the chip

ConfigReg_1 **Offset**
Configuration Register 1 **0B_H** **Reset Value**
8000_H

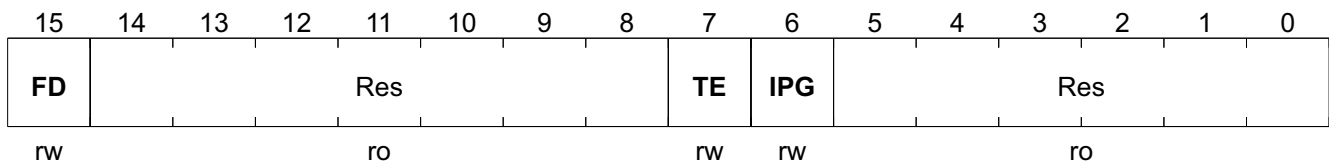

Field	Bits	Type	Description
FD	15	rw	Far End Fault Detection 0 _B D Disable 1 _B E Enable
Res	14:8	ro	Reserved
TE	7	rw	Trunk Enable 0 _B D Disable Port 3 and 4 1 _B E Enable Port 3 and 4
IPG	6	rw	Inter Packet Gap Setting 0 _B 96B 96 bits 1 _B 92B 92 bits
Res	5:0	ro	Reserved

Reserved Register 5

Reserved for future use

32 Bits Mode Registers Description

ResReg_5 **Offset**
Reserved Register 5 **0C_H** **Reset Value**
FA50_H

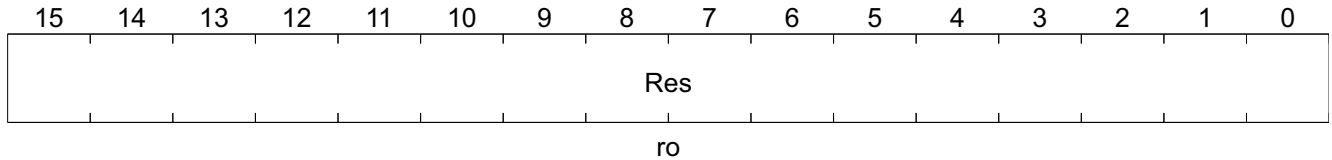

Field	Bits	Type	Description
Res	15:0	ro	Reserved

Similar Registers

Table 16 Reserved Register 6

Register Short Name	Register Long Name	Offset Address	Page Number
ResReg_6	Reserved Register 6	0D _H	

VLAN Priority Map Register

Sets the VLAN priorities

VLAN_Map_P **Offset**
VLAN priority Map Register **0E_H** **Reset Value**
5500_H

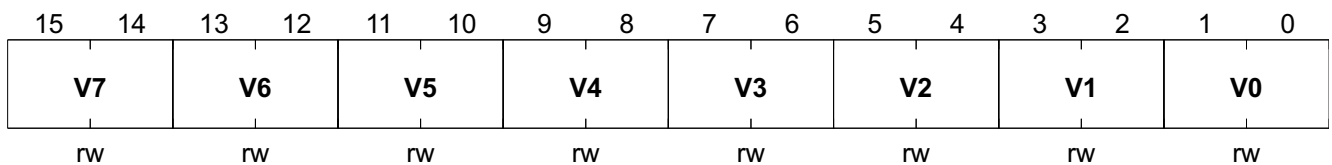

Field	Bits	Type	Description
V7	15:14	rw	Mapped priority of tag value (VLAN)
V6	13:12	rw	
V5	11:10	rw	
V4	9:8	rw	
V3	7:6	rw	
V2	5:4	rw	
V1	3:2	rw	
V0	1:0	rw	

Note: Value 3 ~ 0 are for priority queue Q3~Q0 respectively. The Weight ratio is Q3: Q2: Q1: Q0 = 8: 4: 2: 1. The default is port-base priority for un-tagged packets and non_IP frame.

32 Bits Mode Registers Description

Type of Service (TOS) Priority Map Register

Sets TOS priority

TOS_Priority **Offset**
TOS priority Map Register **0F_H** **Reset Value**
5500_H

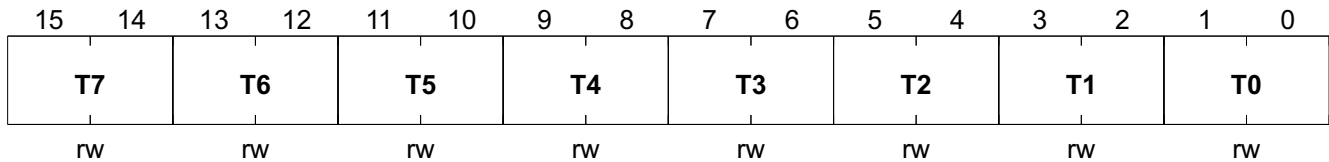

Field	Bits	Type	Description
T7	15:14	rw	Mapped priority of tag value (TOS)
T6	13:12	rw	
T5	11:10	rw	
T4	9:8	rw	
T3	7:6	rw	
T2	5:4	rw	
T1	3:2	rw	
T0	1:0	rw	

Note: Value 3 ~ 0 are for priority queues Q3~Q0 respectively. The Weight ratio is Q3: Q2: Q1: Q0 = 8: 4: 2: 1. The default is port-based priority for un-tagged packets and non_IP frames.

Configuration Register 2

Used to configure the chip

ConfigReg_2 **Offset**
Configuration Register 2 **10_H** **Reset Value**
0040_H

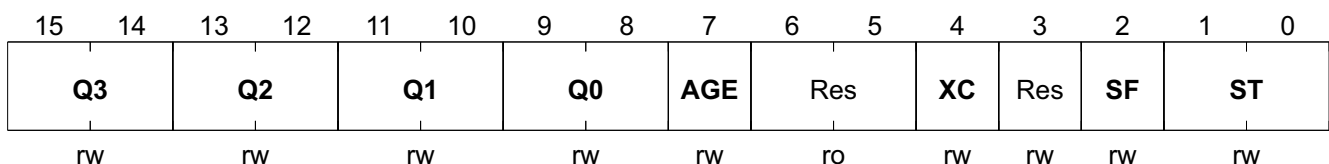

Field	Bits	Type	Description
Q3	15:14	rw	Discard mode Drop scheme for Queue n. See Table 19 for details on the drop scheme of each queue
Q2	13:12	rw	
Q1	11:10	rw	
Q0	9:8	rw	

32 Bits Mode Registers Description

Field	Bits	Type	Description
AGE	7	rw	Aging Status 0 _B E Enable 1 _B D Disable
Res	6:5	ro	Reserved
XC	4	rw	CRC Check 0 _B E Enable CRC check 1 _B D Disable CRC check
Res	3	rw	Reserved
SF	2	rw	Broadcast Storm Filter 0 _B D Disable 1 _B E Enable
ST	1:0	rw	Broadcast Storm Threshold See below Table 17 and Table 18 for details on the Broadcast Storm Threshold

Note: Broadcast storm initial time interval = 50ms. The max. packet number = 7490 in 100Base, 749 in 10Base

Table 17 The max. packet number = 7490 in 100Base, 749 in 10Base

Per Port Rising Threshold

	00 _B	01 _B	10 _B	11 _B
All 100TX	Disable	14880fps	29760fps	59520fps
Not All 100TX	Disable	1488fps	2976fps	5952fps

Table 18 The max. packet number = 7490 in 100Base, 749 in 10Base

Per Port Falling Threshold

	00 _B	01 _B	10 _B	11 _B
All 100TX	Disable	7440fps	14880fps	29760fps
Not All 100TX	Disable	744fps	1488fps	2976fps

Table 19 Drop Scheme for Each Queue

Discard Mode Utilization	00	01	10	11
TBD	0%	0%	25%	50%

VLAN mode select Register

Selects VLAN Mode

VLAN_Mode	Offset	Reset Value
VLAN Mode Select Register	11_H	FF00_H

32 Bits Mode Registers Description

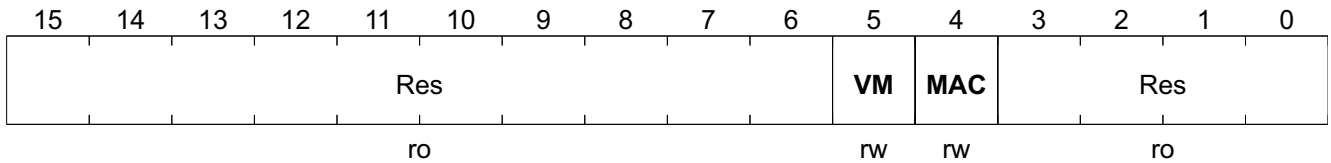

Field	Bits	Type	Description
Res	15:6	ro	Reserved
VM	5	rw	VLAN Mode Select 0 _B P Port based by-pass mode 1 _B Q 802.1Q based
MAC	4	rw	MAC Clone Enable 0 _B N Normal Mode.Learning with SA only. The MAC table will be searched or filled using only SA or DA. 1 _B M Mac Mode. Learned using SA VID0. MAC table will be searched or filled using VID0 SA or DA. This bit allows two identical addresses with different VID0 to be learned.
Res	3:0	ro	Reserved

Note:

Below is an example of a VLAN Tag and a MAC application for Bit4 and Bit5.

Below is an old router architecture example. The disadvantages of this are:

1. WAN port only supports 10M Half-Duplex and non-MDIX functions
2. Needs extra 10M NIC cost.
3. ISA bus will become a bottleneck for the whole system

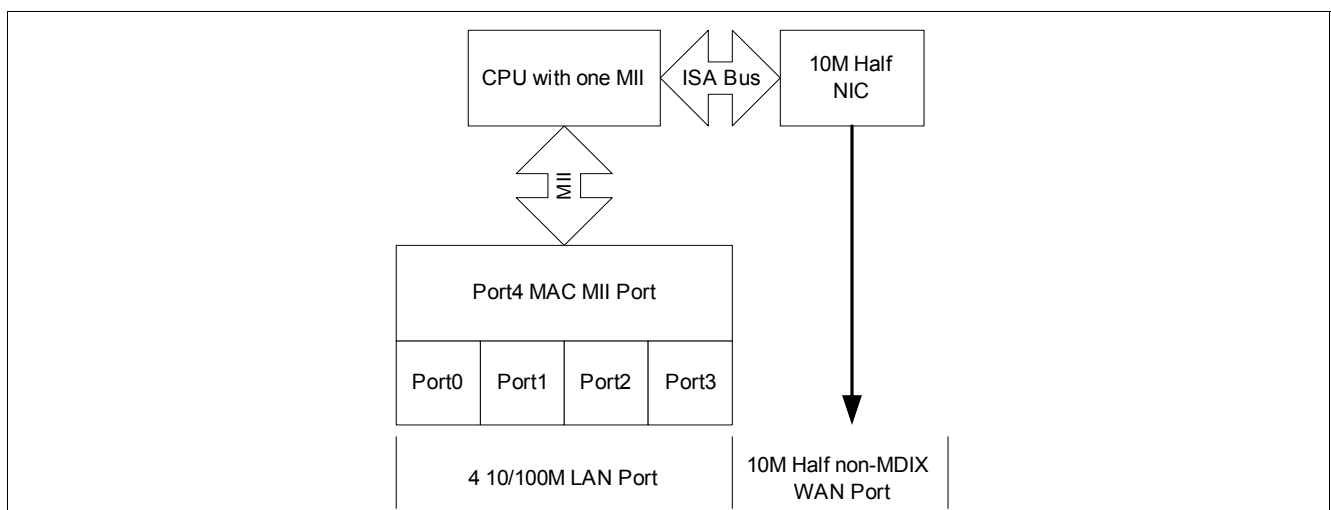

Figure 8 Old Router Architecture Example

Below is new architecture by using ADM6996LC/LCX/LHX serial chip VLAN function. The advantages of below are:

1. WAN Port can upgrade to 100/10 Full/Half, Auto MDIX.
2. WAN/LAN Port is programmable and put on same Switch.

3. No need extra NIC and save lot of cost.
4. High bandwidth of MII port up to 200M speed.

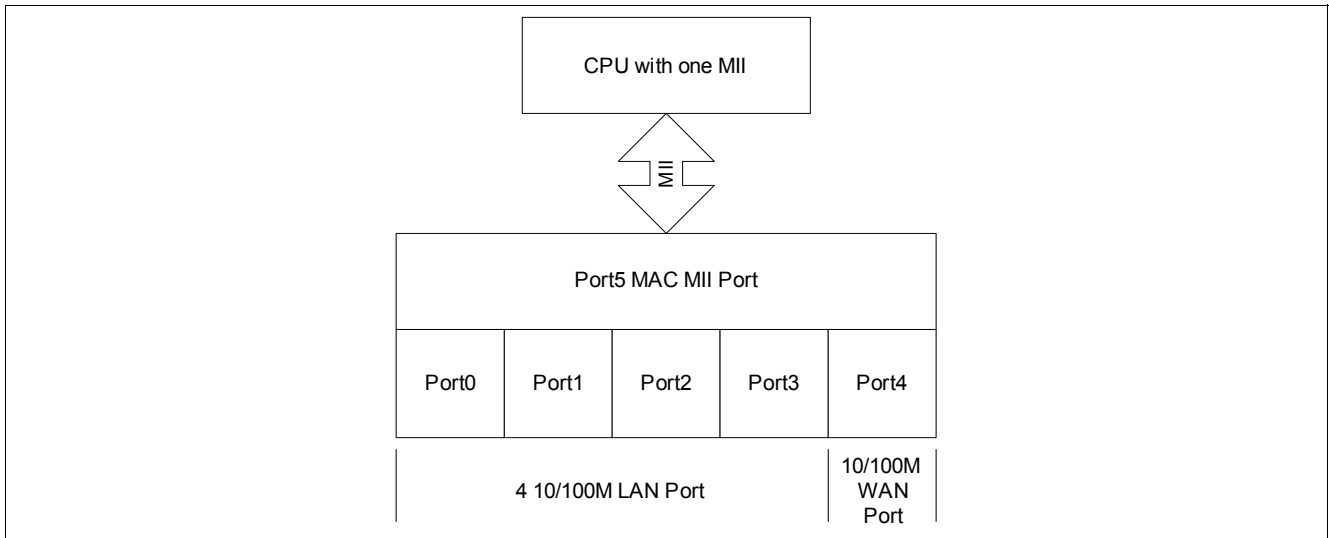

Figure 9 New Router Architecture using ADM6996LC/LCX/LHX

New Router application works well on normal application. If user's ISP vendor(cable modem) lock Registration Card's ID then Router CPU must send this Lock Registration Card's ID to WAN Port. One condition happen is there exist two same MAC ID on this Switch. One is original Card and another one is CPU. This will make Switch learning table trouble.

ADM6996LC/LCX/LHX provide MAC Clone function that allow two same MAC address with different VLAN ID0 on learning table. This will solve Lock registration Card's ID issue. ADM6996 series chip will put these two same MAC addresses with different VLAN ID0 at different learning table entry.

How to Set ADM6996LC/LCX/LHX on Router

Port0~3: LAN Port.

Port4: WAN Port.

Port5: MII Port as CPU Port.

Step1: Set Register 0x11h bit4 and bit5 to 1.

{Coding: Write Register 0x11h as 0xff30h}

Step2: Set Port0~3 as Untag Port and set PVID=1.

{Coding: Write Register 0x01h, 0x03h, 0x05h, 0x07h as 0x840f. Port0~3 as Untag, PVID=1, Enable MDIX}

Step3: Set Port4 as Untag Port and set PVID=2.

{Coding:Write Register 0x08h as 0x880fh. Port4 as Untag, PVID=2, Enable MDIX.}

Step4: Set Port5 MII Port as Tag Port and set PVID=2.

{Coding:Write Register 0x09h as 0x881fh. Port5 MII port as Tag, PVID=2.}

Step5: Group Port0, 1, 2, 3, 5 as VLAN 1.

{Coding: Write Register 0x14h as 0x0155h. VLAN1 cover Port0, 1, 2, 3, 5.}

Step6: Group Port4, 5 as VLAN 2.

{Coding: Write Register 0x15h as 0x0180h. VLAN2 cover Port4, 5.}

How MAC Clone Operation

- LAN to LAN/CPU Traffic.

ADM6996LC/LCX/LHX LAN traffic to LAN/CPU only. Traffic to another LAN port will be

32 Bits Mode Registers Description

untag packet. Traffic to CPU is Tag packet with VID=1. CPU can check VID to distinguish LAN traffic or WAN traffic.

- WAN to CPU Traffic.

ADM6996LC/LCX/LHX WAN traffic to CPU only. Traffic to CPU is Tag packet with VID=2.

CPU can check VID to distinguish LAN traffic or WAN traffic.

- CPU to LAN Packet.

ADM6996LC/LCX/LHX CPU Packet to LAN port must add VID=1 in VLAN field.

ADM6996LC/LCX/LHX check VID to distinguish LAN traffic or WAN traffic. LAN output packet is Untag.

- CPU to WAN Packet.

ADM6996LC/LCX/LHX CPU Packet to WAN port must add VID=2 in VLAN filed.

ADM6996LC/LCX/LHX check VID to distinguish LAN traffic or WAN traffic. WAN output packet is Untag.

- ADM6996LC/LCX/LHX learning sequence

ADM6996LC/LCX/LHX will check VLAN mapping setting first then check learning table.

User does not worry LAN/WAN traffic mix up.

Bit 10: Half Duplex Back Pressure enable. 1/enable, 0/disable.

Configuration Register 3

ConfigReg_3	Offset	Reset Value
Miscellaneous Configuration Register 3	12_H	3600_H

15	14	13	12	11	10	9	8	7	6	5	4	3	2	1	0
CD	DCS			Res			ML5	ML4	ML3	Res	ML2	Res	ML1	Res	ML0
rw	rw			rw			rw	rw	rw	rw	rw	rw	rw	rw	rw

Field	Bits	Type	Description
CD	15	rw	Excessive Collision Drop 0 _B D Disable 1 _B E Enable
DCS	14	rw	Duplex and Col Separate 0 _B D Indicate the duplex and collision status at the same time 1 _B LM Indicate the duplex status only
Res	13:9	rw	Reserved
ML5	8	rw	Port5 MAC Lock 0 _B D Disable 1 _B LM Lock first MAC Source Address
ML4	7	rw	Port4 MAC Lock 0 _B D Disable 1 _B LM Lock first MAC Source Address

32 Bits Mode Registers Description

Field	Bits	Type	Description
ML3	6	rw	Port3 MAC Lock 0 _B D Disable 1 _B LM Lock first MAC Source Address
Res	5	rw	Reserved
ML2	4	rw	Port 2 MAC Lock 0 _B D Disable 1 _B LM Lock first MAC source address
Res	3	rw	Reserved
ML1	2	rw	Port1 MAC Lock 0 _B D Disable 1 _B LM Lock first MAC source address
Res	1	rw	Reserved
ML0	0	rw	Port0 MAC Lock 0 _B D Disable 1 _B LM Lock first MAC source address

VLAN Mapping Table Registers 0

VLAN_Map_0 **Offset** **Reset Value**
VLAN mapping table registers 0 **13_H** **FFFF_H**

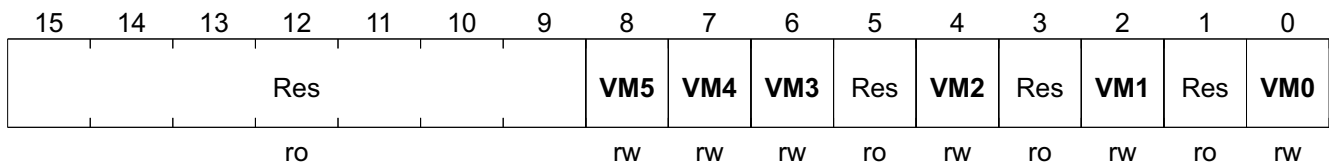

Field	Bits	Type	Description
Res	15:9	ro	Reserved
VM5	8	rw	Port 5 VLAN Mapping 0 _B NM Port 5 is not the member of the VLAN. 1 _B M Port 5 is the member of the VLAN.
VM4	7	rw	Port 4 VLAN Mapping 0 _B NM Port 4 is not the member of the VLAN. 1 _B M Port 4 is the member of the VLAN.
VM3	6	rw	Port 3 VLAN Mapping 0 _B NM Port 3 is not the member of the VLAN. 1 _B M Port 3 is the member of the VLAN.
Res	5	ro	Reserved
VM2	4	rw	Port 2 VLAN Mapping 0 _B NM Port 2 is not the member of the VLAN. 1 _B M Port 2 is the member of the VLAN.
Res	3	ro	Reserved

32 Bits Mode Registers Description

Field	Bits	Type	Description
VM1	2	rw	Port 1 VLAN Mapping 0 _B NM Port 1 is not the member of the VLAN. 1 _B M Port 1 is the member of the VLAN.
Res	1	ro	Reserved
VM0	0	rw	Port 0 VLAN Mapping 0 _B NM Port 0 is not the member of the VLAN. 1 _B M Port 0 is the member of the VLAN.

Note: 16 VLAN Group: See Register 0x2ch bit 11. Select the VLAN group ports and set the corresponding bits to 1.

Similar Registers

Table 20 VLAN Mapping Table Registers 1 to 15

Register Short Name	Register Long Name	Offset Address	Page Number
VLAN_Map_1	VLAN mapping table registers 1	14 _H	
VLAN_Map_2	VLAN mapping table registers 2	15 _H	
VLAN_Map_3	VLAN mapping table registers 3	16 _H	
VLAN_Map_4	VLAN mapping table registers 4	17 _H	
VLAN_Map_5	VLAN mapping table registers 5	18 _H	
VLAN_Map_6	VLAN mapping table registers 6	19 _H	
VLAN_Map_7	VLAN mapping table registers 7	1A _H	
VLAN_Map_8	VLAN mapping table registers 8	1B _H	
VLAN_Map_9	VLAN mapping table registers 9	1C _H	
VLAN_Map_10	VLAN mapping table registers 10	1D _H	
VLAN_Map_11	VLAN mapping table registers 11	1E _H	
VLAN_Map_12	VLAN mapping table registers 12	1F _H	
VLAN_Map_13	VLAN mapping table registers 13	20 _H	
VLAN_Map_14	VLAN mapping table registers 14	21 _H	
VLAN_Map_15	VLAN mapping table registers 15	22 _H	

Reserved Register 7

ResReg_7	Offset	Reset Value
Reserved Register 7	23_H	0000_H

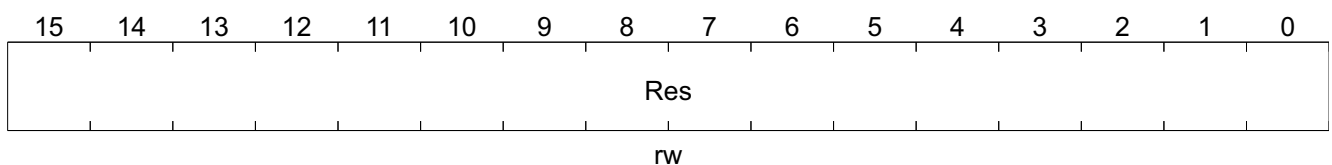

32 Bits Mode Registers Description

Field	Bits	Type	Description
Res	15:0	rw	Reserved

Similar Registers

Table 21 Reserved Register 8 to 11

Register Short Name	Register Long Name	Offset Address	Page Number
ResReg_8	Reserved Register 8	24 _H	
ResReg_9	Reserved Register 9	25 _H	
ResReg_10	Reserved Register 10	26 _H	
ResReg_11	Reserved Register 11	27 _H	

Configuration Register 4

ConfigReg_4 **Offset**
Configuration Register 4 **28_H** **Reset Value**
0000_H

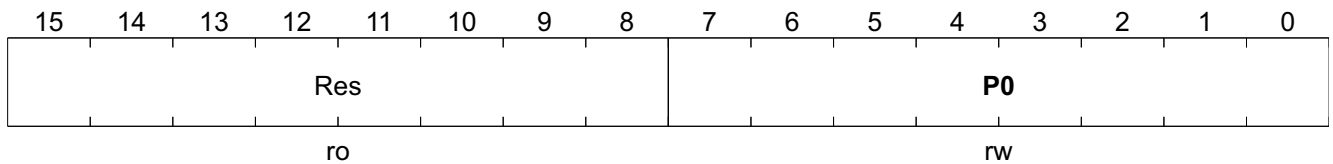

Field	Bits	Type	Description
Res	15:8	ro	Reserved
P0	7:0	rw	Port 0 PVID 0001 _H PVID These 8 bits combine with the register in the hex values bit's [13~10] as the full 12 bits of the VID.

Configuration Register 5

ConfigReg_5 **Offset**
Configuration Register 5 **29_H** **Reset Value**
0000_H

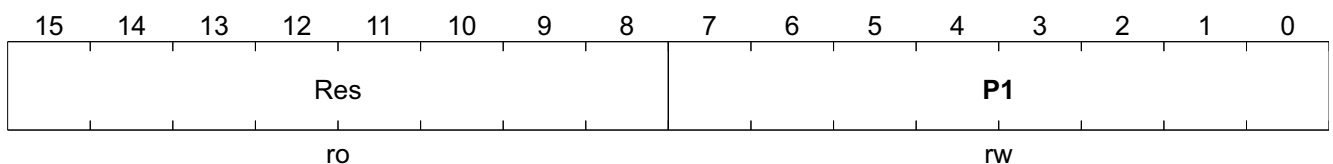

Field	Bits	Type	Description
Res	15:8	ro	Reserved

32 Bits Mode Registers Description

Field	Bits	Type	Description
P1	7:0	rw	Port1 PVID bit 11~4. 0003 _H PVID 1 These 8 bits combine with the register in the hex values bit's [13~10] as the full 12 bits of the VID.

Configuration Register 6

ConfigReg_6 **Offset**
Configuration Register 6 **2A_H** **Reset Value**
0000_H

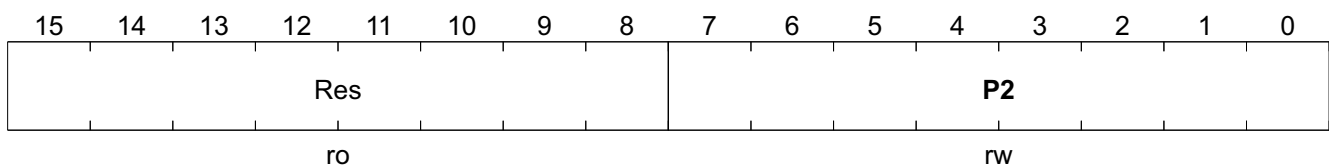

Field	Bits	Type	Description
Res	15:8	ro	Reserved
P2	7:0	rw	Port2 PVID bit 11~4. 0005 _H PVID 2 These 8 bits combine with the register in the hex values bit's [13~10] as the full 12 bits of the VID.

Configuration Register 7

ConfigReg_7 **Offset**
Configuration Register 7 **2B_H** **Reset Value**
0000_H

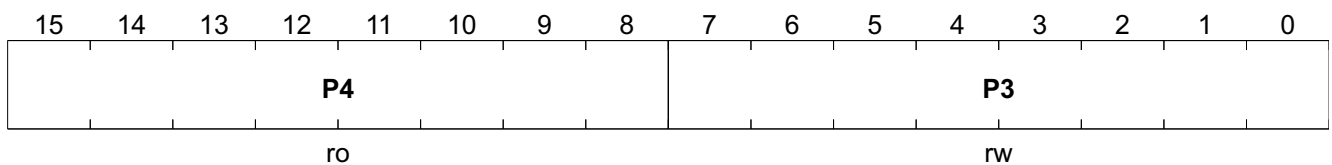

Field	Bits	Type	Description
P4	15:8	ro	Port4 PVID bit 11~4. 0008 _H PVID 1 These 8 bits combine with the register in the hex values bit's [13~10] as the full 12 bits of the VID.
P3	7:0	rw	Port3 PVID bit 11~4. 0007 _H PVID 1 These 8 bits combine with the register in the hex values bit's [13~10] as the full 12 bits of the VID.

Configuration Register 8

32 Bits Mode Registers Description

ConfigReg_8 **Offset**
Configuration Register **2C_H** **Reset Value**
D000_H

15	14	13	12	11	10	9	8	7	6	5	4	3	2	1	0
CR0	CR1	CR2	CR3	Res	VS			P5							
rw	rw	rw	rw	rw	rw			rw							

Field	Bits	Type	Description
CR0	15	rw	Control Reserved MAC Control reserved MAC (0180C2000000) 0 _B D Discard 1 _B F Forward
CR1	14	rw	Control Reserved MAC Control reserved MAC (0180C2000001) 0 _B D Discard 1 _B F Forward
CR2	13	rw	Control Reserved MAC Control reserved MAC (0180C2000002- 0180C200000F) 0 _B D Discard 1 _B F Forward
CR3	12	rw	Control Reserved MAC Control reserved MAC (0180C2000010-0180C20000FF) 0 _B D Discard 1 _B F Forward
Res	11	rw	Reserved
VS	10:8	rw	VLAN Grouping Tag Shift 0 _D VID0 VID [3:0] 1 _D VID1 VID [4:1] 2 _D VID2 VID [5:2] 3 _D VID3 VID [6:3] 4 _D VID4 VID [7:4] 5 _D VID5 VID [8:5] 6 _D VID6 VID [9:6] 7 _D VID7 VID [10:7]
P5	7:0	rw	Port5 PVID bit 11~4. 0009 _H PVID 1 These 8 bits combine with the register in the hex values bit's [13~10] as the full 12 bits of the VID.

Note: Bit[10:8]: VLAN Tag shift register. ADM6996LC/LCX/LHX will select 4 bit form total 12 bit VID as VLAN group reference. Bit[15:12]: IEEE 802.3 reserved DA forward or drop police.

Reserved Register 12

32 Bits Mode Registers Description

ResReg_12 **Offset**
Reserved Register 12 **2D_H** **Reset Value**
4442_H

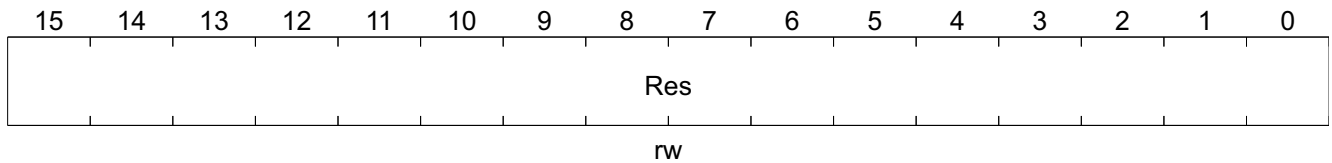

Field	Bits	Type	Description
Res	15:0	rw	Reserved

Reserved Register 13

ResReg_13 **Offset**
Reserved Register 13 **2E_H** **Reset Value**
0000_H

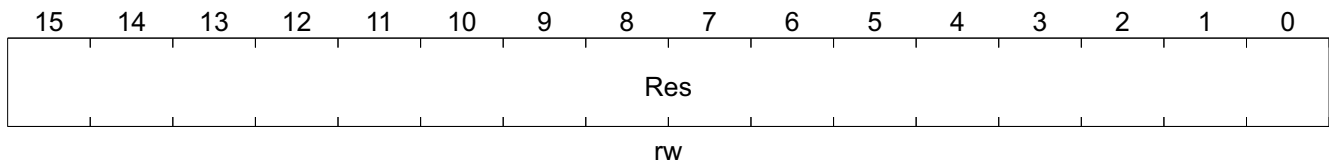

Field	Bits	Type	Description
Res	15:0	rw	Reserved

PHY Restart

PH_Restart **Offset**
PHY Restart **2F_H** **Reset Value**
0000_H

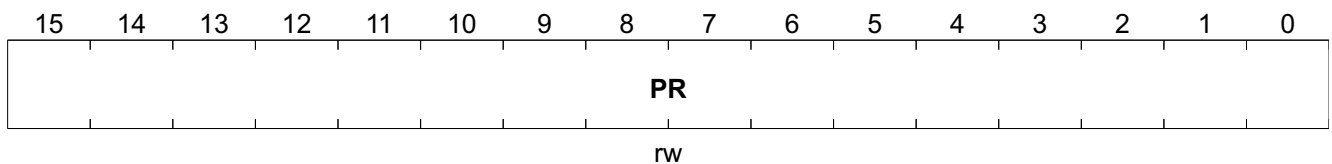

Field	Bits	Type	Description
PR	15:0	rw	PHY Restart 0000 _H PHY Restart Writing this Hex value to this register restarts the internal PHYs.

32 Bits Mode Registers Description

Field	Bits	Type	Description
RC3	15	rw	Receive Packet Length Count Counted on the Source Port 3. 0 _D R3 The switch will add length to the P3 counter
P3T	14:12	rw	Port 3 Threshold Control Meter Reference Table 22 in note below.
RC2	11	rw	Receive Packet Length Count Counted on the Source Port 2. 0 _D R2 The switch will add length to the P2 counter
P2T	10:8	rw	Port 2 Threshold Control Meter Reference Table 22 in note below.
RC1	7	rw	Receive Packet Length Count Counted on the Source Port 1. 0 _D R1 The switch will add length to the P1 counter
P1T	6:4	rw	Port 1 Threshold Control Meter Reference Table 22 in note below.
RC0	3	rw	Receive Packet Length Count Counted on the Source Port 0. 0 _D R0 The switch will add length to the P2 counter
P0T	2:0	rw	Port 0 Threshold Control Meter Reference Table 22 in note below.

Table 22 Note: Reference Table

000	001	010	011	100	101	110	111
256K	512K	1M	2M	5M	10M	20M	50M

Bandwidth Control Register 1

BWCon_1 **Offset**
32_H **Reset Value**
0000_H
Bandwidth Control Register 1

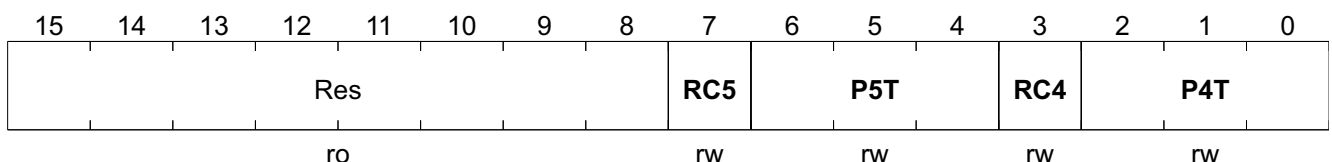

Field	Bits	Type	Description
Res	15:8	ro	Reserved
RC5	7	rw	Receive Packet Length Count Counted on the Source Port 5. 0 _D Count5 The switch will add length to the P5 counter

32 Bits Mode Registers Description

Field	Bits	Type	Description
P5T	6:4	rw	Port 5 Threshold Control Meter Reference Table 22 in note below.
RC4	3	rw	Receive Packet Length Count Counted on the Source Port 4. 0 _D Count4 The switch will add length to the P4 counter
P4T	2:0	rw	Port 4 Threshold Control Meter Reference Table 22 in note below.

Bandwidth Control Enable Register

BWConEn **Offset**
Bandwidth Control Enable Register **33_H** **Reset Value**
0000_H

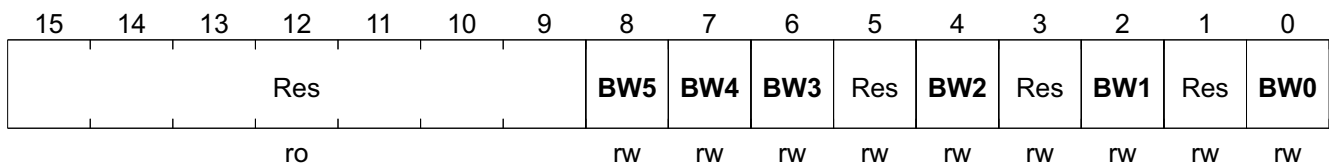

Field	Bits	Type	Description
Res	15:9	ro	Reserved
BW5	8	rw	Port 5 Bandwidth Control Enable 0 _B D Disable 1 _B E Enable
BW4	7	rw	Port 4 Bandwidth Control Enable 0 _B D Disable 1 _B E Enable
BW3	6	rw	Port 3 Bandwidth Control Enable 0 _B D Disable 1 _B E Enable
Res	5	rw	Reserved
BW2	4	rw	Port 2 Bandwidth Control Enable 0 _B D Disable 1 _B E Enable
Res	3	rw	Reserved
BW1	2	rw	Port 1 Bandwidth Control Enable 0 _B D Disable 1 _B E Enable
Res	1	rw	Reserved
BW0	0	rw	Port 0 Bandwidth Control Enable 0 _B D Disable 1 _B E Enable

4.2 Serial Registers

Table 23 Registers Address Space

Module	Base Address	End Address	Note
Serial Registers	00 _H	3C _H	Independent Address Space

Table 24 Registers Overview

Register Short Name	Register Long Name	Offset Address	Page Number
ChipID	Chip Identifier Register	00 _H	63
PortStat_0	Port Status Register 0	01 _H	63
PortStat_1	Port Status Register 1	02 _H	65
CabStat	Cable Broken Status	03 _H	66
P0_RP_CNT	Port 0 Receive Packet Count	04 _H	66
P1_RP_CNT	Port 1 Receive Packet Count	06 _H	67
P2_RP_CNT	Port 2 Receive Packet Count	08 _H	67
P3_RP_CNT	Port 3 Receive Packet Count	0A _H	67
P4_RP_CNT	Port 4 Receive Packet Count	0B _H	67
P5_RP_CNT	Port 5 Receive Packet Count	0C _H	67
P0_RB_CNT	Port 0 Receive Byte Count	0D _H	67
P1_RB_CNT	Port 1 Receive Byte Count	0F _H	67
P2_RB_CNT	Port 2 Receive Byte Count	11 _H	67
P3_RB_CNT	Port 3 Receive Byte Count	13 _H	67
P4_RB_CNT	Port 4 Receive Byte Count	14 _H	67
P5_RB_CNT	Port 5 Receive Byte Count	15 _H	67
P0_TP_CNT	Port 0 Transmit Packet Count	16 _H	67
P1_TP_CNT	Port 1 Transmit Packet Count	18 _H	67
P2_TP_CNT	Port 2 Transmit Packet Count	1A _H	67
P3_TP_CNT	Port 3 Transmit Packet Count	1C _H	67
P4_TP_CNT	Port 4 Transmit Packet Count	1D _H	67
P5_TP_CNT	Port 5 Transmit Packet Count	1E _H	67
P0_TB_CNT	Port 0 Transmit Byte Count	1F _H	67
P1_TB_CNT	Port 1 Transmit Byte Count	21 _H	67
P2_TB_CNT	Port 2 Transmit Byte Count	23 _H	67
P3_TB_CNT	Port 3 Transmit Byte Count	25 _H	67
P4_TB_CNT	Port 4 Transmit Byte Count	26 _H	67
P5_TB_CNT	Port 5 Transmit Byte Count	27 _H	67
P0_COL_CNT	Port 0 Collision Count	28 _H	67
P1_COL_CNT	Port 1 Collision Count	2A _H	67
P2_COL_CNT	Port 2 Collision Count	2C _H	67
P3_COL_CNT	Port 3 Collision Count	2E _H	67
P4_COL_CNT	Port 4 Collision Count	2F _H	67
P5_COL_CNT	Port 5 Collision Count	30 _H	67

Table 24 Registers Overview (cont'd)

Register Short Name	Register Long Name	Offset Address	Page Number
P0_ERR_CNT	Port 0 Error Count	31 _H	67
P1_ERR_CNT	Port 1 Error Count	33 _H	68
P2_ERR_CNT	Port 2 Error Count	35 _H	68
P3_ERR_CNT	Port 3 Error Count	37 _H	68
P4_ERR_CNT	Port 4 Error Count	38 _H	68
P5_ERR_CNT	Port 5 Error Count	39 _H	68
OverFlow_0	Over Flow Flag Register 0	3A _H	68
OverFlow_1	Over Flow Flag Register 1	3B _H	68
OverFlow_2	Over Flow Flag Register 2	3C _H	69

The register is addressed wordwise.

For Register Access Types see [Table 12 “Register Access Types” on Page 42](#).

Table 25 Registers Clock Domains

Clock Short Name	Description
–	–

4.2.1 Serial Register Map

Chip Identifier Register

ChipID	Offset	Reset Value
Chip Identifier Register	00 _H	0007 1022 _H

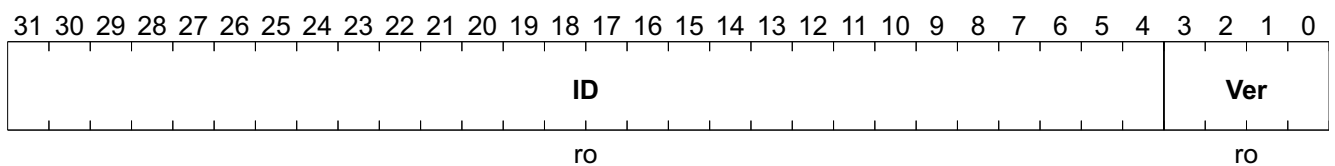

Field	Bits	Type	Description
ID	31:4	ro	Chip Identifier Register 000 7102 _H ID Chip Identifier
Ver	3:0	ro	Version No 2 _H Ver Version No.

Port Status Register 0

PortStat_0	Offset	Reset Value
Port Status Register 0	01 _H	0000 0000 _H

32 Bits Mode Registers Description

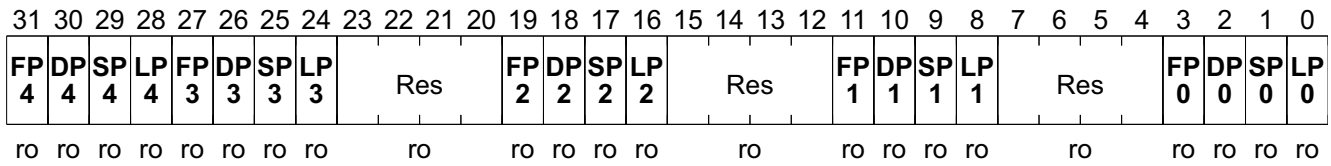

Field	Bits	Type	Description
FP4	31	ro	Port 4 Flow Control Enable 0 _B D Flow Control Disable 1 _B FC4 802.3X on for full duplex or back pressure on for half duplex.
DP4	30	ro	Port 4 Duplex Status 0 _B H Half Duplex 1 _B F Full Duplex
SP4	29	ro	Port 4 Speed Status 0 _B 10 10 Mbit/s 1 _B 100 100 Mbit/s
LP4	28	ro	Port 4 Linkup Status 0 _B NE Link is not established. 1 _B E Link is established.
FP3	27	ro	Port 3 Flow Control Enable 0 _B D Flow Control Disable 1 _B FC3 802.3X on for full duplex or back pressure on for half duplex.
DP3	26	ro	Port 3 Duplex Status 0 _B H Half Duplex 1 _B F Full Duplex
SP3	25	ro	Port 3 Speed Status 0 _B 10 10 Mbit/s 1 _B 100 100 Mbit/s
LP3	24	ro	Port 3 Linkup Status Port 3 Linkup Status: 0 _B N Link is not established. 1 _B E Link is established.
Res	23:20	ro	Reserved
FP2	19	ro	Port 2 Flow Control Enable 0 _B D Flow Control Disable 1 _B FC2 802.3X on for full duplex or back pressure on for half duplex.
DP2	18	ro	Port 2 Duplex Status 0 _B H Half Duplex 1 _B F Full Duplex
SP2	17	ro	Port 2 Speed Status 0 _B 10 10 Mbit/s 1 _B 100 100 Mbit/s
LP2	16	ro	Port 2 Linkup Status Port 2 Linkup Status: 0 _B NE Link is not established. 1 _B E Link is established.
Res	15:12	ro	Reserved

32 Bits Mode Registers Description

Field	Bits	Type	Description
FP1	11	ro	Port 1 Flow Control Enable 0 _B D Flow Control Disable 1 _B FC1 802.3X on for full duplex or back pressure on for half duplex.
DP1	10	ro	Port 1 Duplex Status 0 _B H Half Duplex 1 _B F Full Duplex
SP1	9	ro	Port 1 Speed Status 0 _B 10 10 Mbit/s 1 _B 100 100 Mbit/s
LP1	8	ro	Port 1 Linkup Status 0 _B NE Not established. 1 _B E Established.
Res	7:4	ro	Reserved
FP0	3	ro	Port 0 Flow Control Enable 0 _B D Flow Control Disable 1 _B FC0 802.3X on for full duplex or back pressure on for half duplex.
DP0	2	ro	Port 0 Duplex Status 0 _B H Half Duplex 1 _B F Full Duplex
SP0	1	ro	Port 0 Speed Status 0 _B 10 10 Mbit/s 1 _B 100 100 Mbit/s
LP0	0	ro	Port 0 Linkup Status 0 _B NE Not established. 1 _B E Established.

Port Status Register 1

PortStat_1	Offset	Reset Value
Port Status Register 1	02_H	0000 0000_H

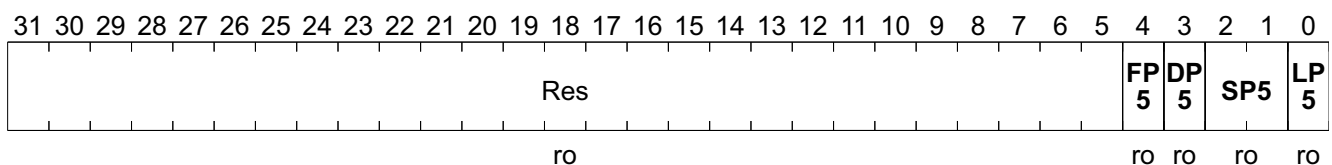

Field	Bits	Type	Description
Res	31:5	ro	Reserved
FP5	4	ro	Port 5 Flow Control Enable 0 _B D Flow Control Disable 1 _B FC5 802.3X on for full duplex or back pressure on for half duplex.
DP5	3	ro	Port 5 Duplex Status 0 _B H Half Duplex 1 _B F Full Duplex

32 Bits Mode Registers Description

Field	Bits	Type	Description
SP5	2:1	ro	Port 5 Speed Status 0 _B 10 10 Mbit/s 1 _B 100 100 Mbit/s
LP5	0	ro	Port 5 Linkup Status 0 _B NE Not established. 1 _B E Established.

Cable Broken Status Register

CabStat **Offset**
Cable Broken Status **03_H** **Reset Value**
0000 0000_H

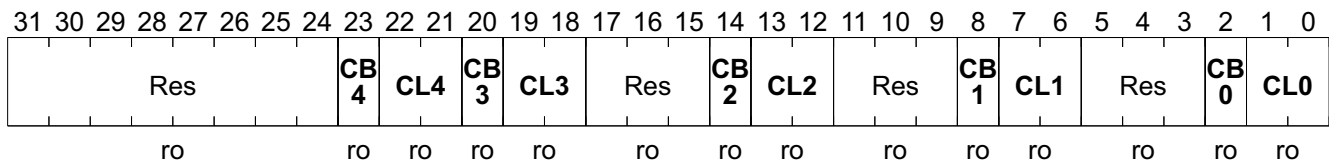

Field	Bits	Type	Description
Res	31:24	ro	Reserved
CB4	23	ro	Port 4 Cable Broken
CL4	22:21	ro	Port 4 Cable Broken Length
CB3	20	ro	Port 3 Cable Broken
CL3	19:18	ro	Port 3 Cable Broken Length
Res	17:15	ro	Reserved
CB2	14	ro	Port 2 Cable Broken
CL2	13:12	ro	Port 2 Cable Broken Length
Res	11:9	ro	Reserved
CB1	8	ro	Port 1 Cable Broken
CL1	7:6	ro	Port 1 Cable Broken Length
Res	5:3	ro	Reserved
CB0	2	ro	Port 0 Cable Broken
CL0	1:0	ro	Port 0 Cable Broken Length

Port 0 Receive Packet Count

P0_RP_CNT **Offset**
Port 0 Receive Packet Count **04_H** **Reset Value**
0000 0000_H

32 Bits Mode Registers Description

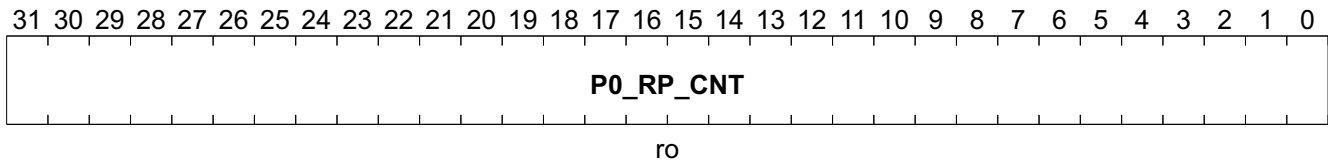

Field	Bits	Type	Description
P0_RP_CNT	31:0	ro	Counter

Similar Registers

Table 26 Per Port Counters

Register Short Name	Register Long Name	Offset Address	Page Number
P1_RP_CNT	Port 1 Receive Packet Count	06 _H	
P2_RP_CNT	Port 2 Receive Packet Count	08 _H	
P3_RP_CNT	Port 3 Receive Packet Count	0A _H	
P4_RP_CNT	Port 4 Receive Packet Count	0B _H	
P5_RP_CNT	Port 5 Receive Packet Count	0C _H	
P0_RB_CNT	Port 0 Receive Byte Count	0D _H	
P1_RB_CNT	Port 1 Receive Byte Count	0F _H	
P2_RB_CNT	Port 2 Receive Byte Count	11 _H	
P3_RB_CNT	Port 3 Receive Byte Count	13 _H	
P4_RB_CNT	Port 4 Receive Byte Count	14 _H	
P5_RB_CNT	Port 5 Receive Byte Count	15 _H	
P0_TP_CNT	Port 0 Transmit Packet Count	16 _H	
P1_TP_CNT	Port 1 Transmit Packet Count	18 _H	
P2_TP_CNT	Port 2 Transmit Packet Count	1A _H	
P3_TP_CNT	Port 3 Transmit Packet Count	1C _H	
P4_TP_CNT	Port 4 Transmit Packet Count	1D _H	
P5_TP_CNT	Port 5 Transmit Packet Count	1E _H	
P0_TB_CNT	Port 0 Transmit Byte Count	1F _H	
P1_TB_CNT	Port 1 Transmit Byte Count	21 _H	
P2_TB_CNT	Port 2 Transmit Byte Count	23 _H	
P3_TB_CNT	Port 3 Transmit Byte Count	25 _H	
P4_TB_CNT	Port 4 Transmit Byte Count	26 _H	
P5_TB_CNT	Port 5 Transmit Byte Count	27 _H	
P0_COL_CNT	Port 0 Collision Count	28 _H	
P1_COL_CNT	Port 1 Collision Count	2A _H	
P2_COL_CNT	Port 2 Collision Count	2C _H	
P3_COL_CNT	Port 3 Collision Count	2E _H	
P4_COL_CNT	Port 4 Collision Count	2F _H	
P5_COL_CNT	Port 5 Collision Count	30 _H	
P0_ERR_CNT	Port 0 Error Count	31 _H	

32 Bits Mode Registers Description

Table 26 Per Port Counters (cont'd)

Register Short Name	Register Long Name	Offset Address	Page Number
P1_ERR_CNT	Port 1 Error Count	33 _H	
P2_ERR_CNT	Port 2 Error Count	35 _H	
P3_ERR_CNT	Port 3 Error Count	37 _H	
P4_ERR_CNT	Port 4 Error Count	38 _H	
P5_ERR_CNT	Port 5 Error Count	39 _H	

Over Flow Flag Register 0

OverFlow_0 **Offset** **Reset Value**
Over Flow Flag Register 0 **3A_H** **0000 0000_H**

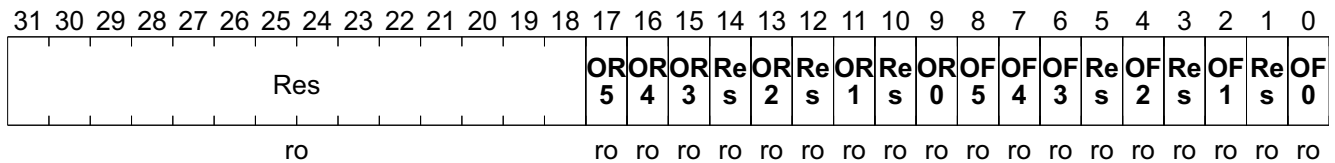

Field	Bits	Type	Description
Res	31:18	ro	Reserved
OR5	17	ro	Overflow of Port 5 Receive Packet Byte Count
OR4	16	ro	Overflow of Port 4 Receive Packet Byte Count
OR3	15	ro	Overflow of Port 3 Receive Packet Byte Count
Res	14	ro	Reserved
OR2	13	ro	Overflow of Port 2 Receive Packet Byte Count
Res	12	ro	Reserved
OR1	11	ro	Overflow of Port 1 Receive Packet Byte Count
Res	10	ro	Reserved
OR0	9	ro	Overflow of Port 0 Receive Packet Byte Count
OF5	8	ro	Overflow of Port 5 Receive Packet Count
OF4	7	ro	Overflow of Port 4 Receive Packet Count
OF3	6	ro	Overflow of Port 3 Receive Packet Count
Res	5	ro	Reserved
OF2	4	ro	Overflow of Port 2 Receive Packet Count
Res	3	ro	Reserved
OF1	2	ro	Overflow of Port 1 Receive Packet Count
Res	1	ro	Reserved
OF0	0	ro	Overflow of Port 0 Receive Packet Count

Over Flow Flag Register 1

32 Bits Mode Registers Description

OverFlow_1 **Offset**
Over Flow Flag Register 1 **3B_H** **Reset Value**
0000 0000_H

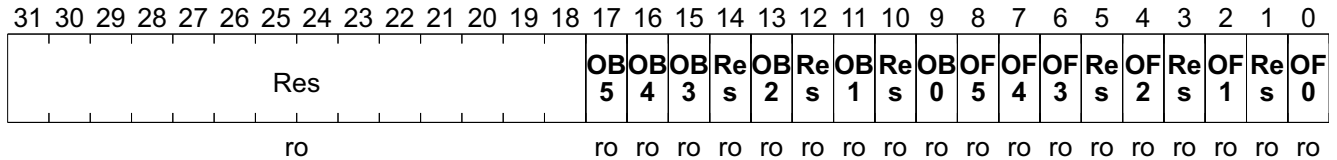

Field	Bits	Type	Description
Res	31:18	ro	Reserved
OB5	17	ro	Overflow of Port 5 Transmit Packet Byte Count
OB4	16	ro	Overflow of Port 4 Transmit Packet Byte Count
OB3	15	ro	Overflow of Port 3 Transmit Packet Byte Count
Res	14	ro	Reserved
OB2	13	ro	Overflow of Port 2 Transmit Packet Byte Count
Res	12	ro	Reserved
OB1	11	ro	Overflow of Port 1 Transmit Packet Byte Count
Res	10	ro	Reserved
OB0	9	ro	Overflow of Port 0 Transmit Packet Byte Count
OF5	8	ro	Overflow of Port 5 Transmit Packet Count
OF4	7	ro	Overflow of Port 4 Transmit Packet Count
OF3	6	ro	Overflow of Port 3 Transmit Packet Count
Res	5	ro	Reserved
OF2	4	ro	Overflow of Port 2 Transmit Packet Count
Res	3	ro	Reserved
OF1	2	ro	Overflow of Port 1 Transmit Packet Count
Res	1	ro	Reserved
OF0	0	ro	Overflow of Port 0 Transmit Packet Count

Over Flow Flag Register 2

OverFlow_2 **Offset**
Over Flow Flag Register 2 **3C_H** **Reset Value**
0000 0000_H

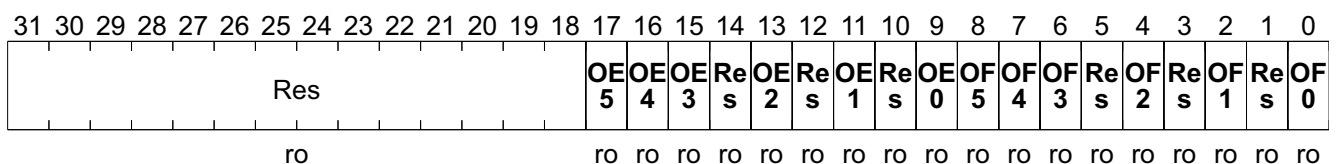

Field	Bits	Type	Description
Res	31:18	ro	Reserved
OE5	17	ro	Overflow of Port 5 Error Count
OE4	16	ro	Overflow of Port 4 Error Count
OE3	15	ro	Overflow of Port 3 Error Count
Res	14	ro	Reserved
OE2	13	ro	Overflow of Port 2 Error Count
Res	12	ro	Reserved
OE1	11	ro	Overflow of Port 1 Error Count
Res	10	ro	Reserved
OE0	9	ro	Overflow of Port 0 Error Count
OF5	8	ro	Overflow of Port 5 Collision Count
OF4	7	ro	Overflow of Port 4 Collision Count
OF3	6	ro	Overflow of Port 3 Collision Count
Res	5	ro	Reserved
OF2	4	ro	Overflow of Port 2 Collision Count
Res	3	ro	Reserved
OF1	2	ro	Overflow of Port 1 Collision Count
Res	1	ro	Reserved
OF0	0	ro	Overflow of Port 0 Collision Count

4.3 Packet with Priority: Normal packet content

Table 27 Ethernet Packet from Layer 2

Preamble/SFD	Destination (6 bytes)	Source (6 bytes)	Packet length (2 bytes)	Data (46-1500 bytes)	CRC (4 bytes)
	Byte 0~5	Byte 6~11	Byte 12~13	Byte 14~	

4.4 VLAN Packet

Table 28 VLAN Packet

Tag Protocol TD 8100	Tag Control Information TCI	LEN Length	Routing Information
Byte 12~13	Byte14~15	Byte 16~17	Byte 18

Note: ADM6996LC/LCX/LHX will check packet byte 12 & 13. If byte[12:13]=8100h then this packet is a VLAN packet

Byte 14~15: Tag Control Information TCI

Bit[15:13]: User Priority 7~0

Bit 12: Canonical Format Indicator (CFI)

Bit[11~0]: VLAN ID. The ADM6996LC/LCX/LHX will use bit[3:0] as VLAN group.

4.5 TOS IP Packet

Table 29 IP Packet

Type 0800	IP Header
Byte 12~13	Byte 14~15

Note: ADM6996LC/LCX/LHX checks bytes 12 & 13. If this value is 0800h then the ADM6996LC/LCX/LHX knows this is a TOP priority packet.

IP header define

Byte 14

Bit[7:0]: IP protocol version number & header length.

Byte 15: Service type

Bit[7~5]: IP Priority (Precedence) from 7~0

Bit 4: No Delay (D)

Bit 3: High Throughput

Bit 2: High Reliability (R)

Bit[1:0]: Reserved

4.6 EEPROM Access

Customer can select ADM6996LC/LCX/LHX read EEPROM contents as chip setting or not. ADM6996LC/LCX/LHX will check the signature of EEPROM to decide read content of EEPROM or not.

Table 30 RESETL & EEPROM content relationship

RESETL	CS	SK	DI	DO
0	High Impedance	High Impedance	High Impedance	High Impedance
Rising edge 01 (30ms)	Output	Output	Output	Input
1 (after 30ms)	Input	Input	Output	Input

Keep at least 30ms after RESETL from 01. ADM6996LC/LCX/LHX will read data from EEPROM. After RESETL if CPU update EEPROM that ADM6996LC/LCX/LHX will update configuration registers too.

When CPU programming EEPROM & ADM6996LC/LCX/LHX, ADM6996LC/LCX/LHX recognizes the EEPROM WRITE instruction only. If there is any Protection instruction before or after the EEPROM WRITE instruction, CPU needs to generate separated CS signal cycle for each Protection & WRITE instruction.

CPU can directly program ADM6996LC/LCX/LHX after 30ms of Reset signal rising edge with or without EEPROM. ADM6996LC/LCX/LHX serial chips will latch hardware-reset value as recommend value. It includes EEPROM interface:

EECS: Internal Pull down 40K resistor.

EESK: TP port Auto-MDIX select. Internal pull down 40K resistor as non Auto-MDIX mode.

EDI: Dual Color Select. Internal pull down 40K resistor as Single Color Mode.

EDO: EEPROM enable. Internal pull up 40K resistor as EEPROM enable.

Below Figure is ADM6996LC/LCX/LHX serial chips EEPROM pins operation at different stage. Reset signal is control by CPU with at least 100ms low. Point1 is Reset rising edge. CPU must prepare proper value on EECS(0),

32 Bits Mode Registers Description

EESK, EDI, EDO(1) before this rising edge. ADM6996LC/LCX/LHX will read this value into chip at Point2. CPU must keep these values over point2. Point2 is 200ns after Reset rising edge.

ADM6996LC/LCX/LHX serial chips will read EEPROM content at Point4 which 800ns far away from the rising edge of Reset. CPU must turn EEPROM pins EECS, EESK, EDI and EDO to High-Z or pull high before Point4.

If user want change state to High-Z or pull high on EEPROM pins, the order is CS-> DI -> DO -> SK is better.

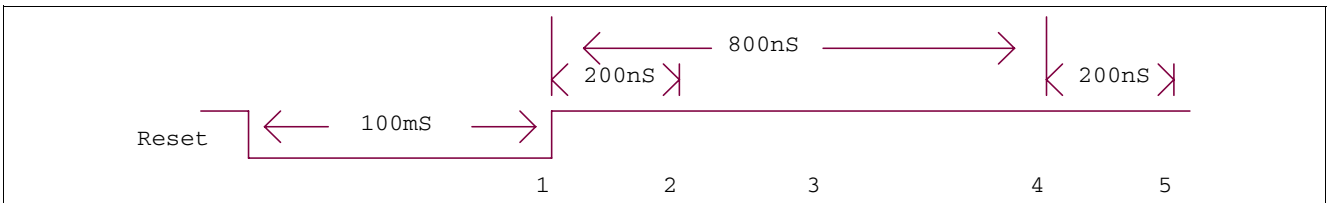

Figure 10 CPU Generated Reset Signal Requirement

A little bit different with the timing on writing EEPROM. See below graph. Must be careful when CS goes down after writing a command, SK must issue at least one clock. This is a difference between ADM6996LC/LCX/LHX with EEPROM write timing. If system without EEPROM then user must write ADM6996LC/LCX/LHX internal register by 93C66 timing. If user uses EEPROM then the writing timing is depend on EEPROM type.

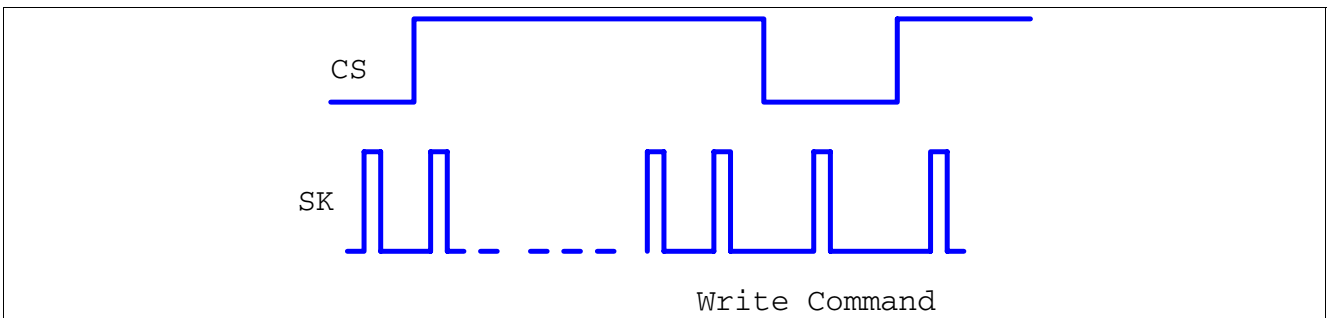

Figure 11 CPU Write EEPROM Command Requirement

4.7 Serial Interface Timing

ADM6996LC/LCX/LHX serial chip's internal counter or EEPROM access timing

EESK: Similar to the MDC signal.

EDI: Similar to the MDIO signal

ECS: Must keep be kept low.

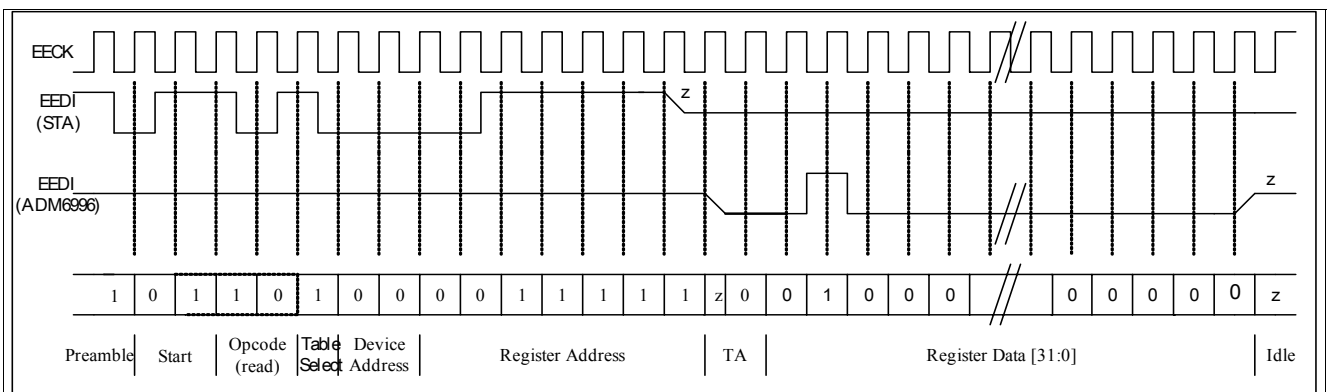

Figure 12 Serial Interface Read Command Timing

Preamble: At least 32 continuous 1_B's

Start: 01_B(2 bits)

Opcode: 10_B (2 bits, Only supports a read command)

Table select: 1_B = Counter, 0_B = EEPROM (1 bit)

Register Address: Read Target register address. (7 bits)

TA: Turn Around.

Register Data: 32 bit data.

Counter output bit sequence is bit 31 to bit 0.

If a user reads the EEPROM then 32 bits of data will separate as two EEPROM registers. The sequence is:

1. Register +1, Register (Register is even number)
2. Register, Register-1(Register is Odd number)

Example:

Read Register 00_H then the ADM6996LC/LCX/LHX will drive 01_H & 00_H

Read Register 03_H then ADM6996LC/LCX/LHX will drive 03_H & 02_H

Idle: EESK must send at least one clock pulse at idle time

ADM6996LC/LCX/LHX issue Reset internal counter command

EESK: Similar to the MDC signal

EDI: Similar to the MDIO signal

ECS: Must keep low.

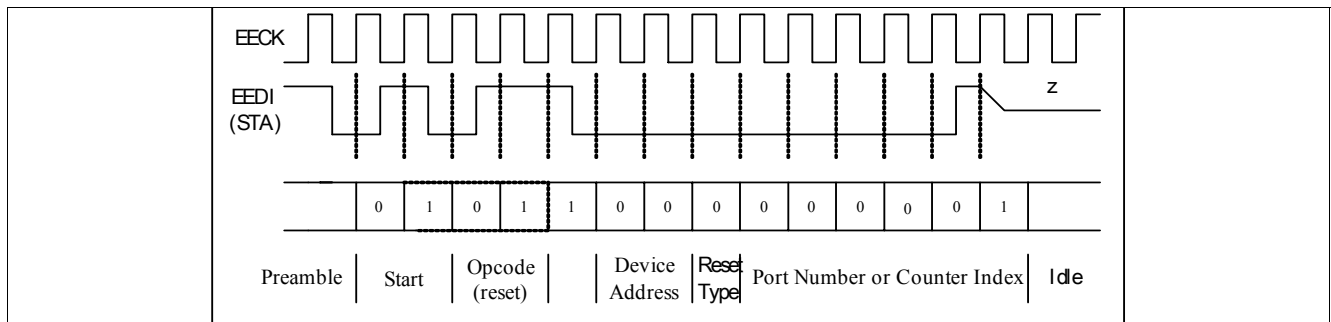

Figure 13 Serial Interface Reset Command Timing

Preamble: At least 32 continuous 1_B's

Start: 01_B(2 bits)

Opcode: 01_B (2 bits, Reset command)

Device Address: Chip physical address as PHYAS[1:0].

Reset_type: Reset the counter by port number or by counter index

1_B = Clear dedicate port's all counters

0_B = Clear dedicate counter

Port_number or counter index: User defines clear port or counter

Idle: EESK must send at least one clock pulse at idle time

5 16 Bits Mode Registers Description

Broadcast Storm

ADM6996LC/LCX/LHX allows users to limit the traffic of the broadcast address (DA = FFFFFFFF_H) to prevent them from blocking the switch bandwidth. If users also want to limit the multicast packets (DA[40] = 1_B), they can set the Multicast Packet Counted into Storming Counter (see 0010_H, **MP**) function. Two threshold and storm enable bits (see 003B_H and 003C_H, **STORM_EN**, **STORM_100_TH**, **STORM_10_TH**) are used to control the broadcast storm. The threshold is described in [Table 31 Broadcast Storming Threshold](#).

1. Time Scale. ADM6996LC/LCX/LHX uses 50ms as the scale to meter the storm packets.
2. Storm keeps on at least 1.6 seconds if any of the ports meet the rising threshold in the 4 consecutive 50 ms intervals. In these 1.6 seconds, the ports meet the rising threshold and will start to discard the broadcast or multicast packets until the 50 ms interval expires. Users could also disable Input Filter (see 000B_H, **IF**) function to forward above packets to the un-congested port instead of discarding directly.
3. Storm finishes. After the 1.6-second storm period, ADM6996LC/LCX/LHX will check the port that makes the storm on. If all of these ports meet the falling threshold in the 2 consecutive 50 ms intervals and no other ports meet the rising threshold at the same time, ADM6996LC/LCX/LHX will treat it the storm has finished.

Priority Queue

ADM6996LC/LCX/LHX supports 4 priority queues and each is assigned a weight. User can see [Priority Queue Weight Ratio](#) for more detail.

The EEPROM provides ADM6996LC/LCX/LHX with many option settings

Main Settings

- Port Configuration: Speed, Duplex, Flow Control Capability and Tag/ Untag.
- VLAN & TOS Priority Mapping
- Broadcast Storming rate and Trunk.
- Fiber Select, Auto MDIX select
- VLAN Mapping
- Per Port Buffer number
- Priority queue and smart discard ratio

Table 31 Broadcast Storming Threshold

Parameter	Rising Threshold	Falling Threshold
All link ports are 100M	100M Threshold (See 003B _H)	1/2 100M Threshold
Not All link ports are 100M	10M Threshold (See 003C _H)	1/2 10M Threshold

Table 32 Priority Queue Weight Ratio

Queue	Weight
Queue 0	Weight = 1
Queue 1	Weight = "Queue 1 Weight" bits in 0025 _H
Queue 2	Weight = "Queue 2 Weight" bits in 0026 _H
Queue 3	Weight = "Queue 3 Weight" bits in 0027 _H

Table 33 Registers Address Space

Module	Base Address	End Address	Note
EEPROM Basic Register Map	0000 _H	003F _H	
EEPROM Extended Register Map	0040 _H	009C _H	
Counter and Switch Status Map	00A0 _H	0143 _H	
PHY Register Map	0200 _H	02FF _H	

Table 34 Registers Overview

Register Short Name	Register Long Name	Offset Address	Page Number
SIG	Signature Register	00 _H	85
P0BC	P0 Basic Control Register	01 _H	85
Res0	Reserved Register 0	02 _H	87
P1	Basic Control Register 1	03 _H	86
Res1	Reserved Register 1	04 _H	87
P2	Basic Control Register 2	05 _H	86
Res2	Reserved Register 2	06 _H	87
P3	Basic Control Register 3	07 _H	86
P4	Basic Control Register 4	08 _H	87
P5	Basic Control Register 5	09 _H	87
SC0	System Control Register 0	0A _H	88
SC1	System Control Register 1	0B _H	89
Res3	Reserved Register 3	0C _H	87
Res4	Reserved Register 4	0D _H	87
VPM	VLAN Priority Map Register	0E _H	90
TPM	TOS Priority Map Register	0F _H	91
SC2	System Control Register 2	10 _H	92
SC3	System Control Register 3	11 _H	92
SC4	System Control Register 4	12 _H	94
P0SO	Port 0 Security Option	13 _H	95
P1SO	Port 1 Security Option	14 _H	96
P2SO	Port 2 Security Option	15 _H	96
P3SO	Port 3 Security Option	16 _H	96
P4SO	Port 4 Security Option	17 _H	96
P5SO	Port 5 Security Option	18 _H	96
UFGPM	Unicast Port Map and Forward Group Port Map	19 _H	96
BFGPM	Broadcast Port Map and Forward Group Port Map	1A _H	97
MFGPM	Multicast Port Map and Forward Group Port Map	1B _H	98
RFGPM	Reserve Port Map and Forward Group Port Map	1C _H	98
PIOFGPM	Packet Identification Option, Forward Group Port Map	1D _H	99

16 Bits Mode Registers Description

Table 34 Registers Overview (cont'd)

Register Short Name	Register Long Name	Offset Address	Page Number
VPEFGPM	VLAN Priority Enable and Forward Group Port Map	1E _H	100
SPEFGPM	Service Priority Enable and Forward Group Port Map	1F _H	101
IFNTFGPM	Input Force No Tag and Forward Group Port Map	20 _H	102
IFFGPM	Ingress Filter and Forward Group Port Map	21 _H	103
VSDFGPM	VLAN Security Disable and Forward Group Port Map	22 _H	104
Res5	Reserved Register 5	23 _H	87
Res6	Reserved Register 6	24 _H	87
IMEIJT	IGMP/MLDTRAP Enable and Input Jam Threshold Register	25 _H	105
Q2WVECPO	Queue 2 Weight, VID Exist Check, and PPPOE Port Only	26 _H	105
Q3WBPVAO	Queue 3 Weight, Back to Port VLAN, and Admit Only VLAN-Tagged	27 _H	106
IDTEP	Input Double Tag Enable, and P0VID[11:4]	28 _H	106
ODTEP	Output Double Tag Enable, and P1VID[11:4]	29 _H	107
OTBP	Output Tag Bypass, and P2VID[11:4]	2A _H	107
P11_4	P3VID[11:4], and P4VID[11:4]	2B _H	108
RACP	Reserved Address Control, and P5VID[11:4]	2C _H	108
PHYC	PHY Control Register	2D _H	108
ATET	ADM TAG Ether Type	2E _H	109
PR	PHY Restart Register	2F _H	109
MISC	Miscellaneous Register	30 _H	110
BBC0	Basic Bandwidth Control Register 0	31 _H	111
BBC1	Basic Bandwidth Control Register 1	32 _H	111
BCE	Bandwidth Control Enable Register	33 _H	112
EBC0	Extended Bandwidth Control Register 0	34 _H	114
EBC1	Extended Bandwidth Control Register 1	35 _H	114
EBC2	Extended Bandwidth Control Register 2	36 _H	115
EBC3	Extended Bandwidth Control Register 3	37 _H	115
EBC4	Extended Bandwidth Control Register 4	38 _H	116
EBC5	Extended Bandwidth Control Register 5	39 _H	117
DVMEBC6	Default VLAN Member and Extended Bandwidth Control Register 6	3A _H	117
NS0	New Storm Register 0	3B _H	118
NS1	New Storm Register 1	3C _H	118
NRAC0	New Reserve Address Control Register 0	3D _H	119
NRAC1	New Reserve Address Control Register 1	3E _H	120
Res7	Reserved Register 7	3F _H	87
VF0L	VLAN Filter 0 Low	40 _H	122

Table 34 Registers Overview (cont'd)

Register Short Name	Register Long Name	Offset Address	Page Number
VF0H	VLAN Filter 0 High	41 _H	123
VF1L	VLAN Filter 1 Low	42 _H	122
VF1H	VLAN Filter 1 High	43 _H	123
VF2L	VLAN Filter 2 Low	44 _H	122
VF2H	VLAN Filter 2 High	45 _H	123
VF3L	VLAN Filter 3Low	46 _H	122
VF3H	VLAN Filter 3 High	47 _H	123
VF4L	VLAN Filter 4 Low	48 _H	122
VF4H	VLAN Filter 4 High	49 _H	123
VF5L	VLAN Filter 5 Low	4A _H	122
VF5H	VLAN Filter 5 High	4B _H	123
VF6L	VLAN Filter 6 Low	4C _H	122
VF6H	VLAN Filter 6 High	4D _H	123
VF7L	VLAN Filter 7 Low	4E _H	122
VF7H	VLAN Filter 7 High	4F _H	123
VF8L	VLAN Filter 8 Low	50 _H	122
VF8H	VLAN Filter 8 High	51 _H	123
VF9L	VLAN Filter 9 Low	52 _H	122
VF9H	VLAN Filter 9 High	53 _H	123
VF10L	VLAN Filter 10 Low	54 _H	122
VF10H	VLAN Filter 10 High	55 _H	123
VF11L	VLAN Filter 11 Low	56 _H	122
VF11H	VLAN Filter 11 High	57 _H	123
VF12L	VLAN Filter 12 Low	58 _H	122
VF12H	VLAN Filter 12 High	59 _H	123
VF13L	VLAN Filter 13 Low	5A _H	122
VF13H	VLAN Filter 13 High	5B _H	123
VF14L	VLAN Filter 14 Low	5C _H	122
VF14H	VLAN Filter 14 High	5D _H	123
VF15L	VLAN Filter 15 Low	5E _H	122
VF15H	VLAN Filter 15 High	5F _H	123
TF0	Type Filter 0	60 _H	124
TF1	Type Filter 1	61 _H	124
TF2	Type Filter 2	62 _H	124
TF3	Type Filter 3	63 _H	124
TF4	Type Filter 4	64 _H	124
TF5	Type Filter 5	65 _H	124
TF6	Type Filter 6	66 _H	124
TF7	Type Filter 7	67 _H	124
PF_1_0	Protocol Filter 1 and 0	68 _H	124
PF_3_2	Protocol Filter 3 and 2	68 _H	125

Table 34 Registers Overview (cont'd)

Register Short Name	Register Long Name	Offset Address	Page Number
PF_5_4	Protocol Filter 5 and 4	69 _H	125
PF_7_6	Protocol Filter 7 and 6	6A _H	125
Res8	Reserved Register 8	6C _H	87
Res9	Reserved Register 9	6D _H	87
Res10	Reserved Register 10	6E _H	87
Res11	Reserved Register 11	6F _H	87
Res12	Reserved Register 12	70 _H	87
Res13	Reserved Register 13	71 _H	87
Res14	Reserved Register 14	72 _H	87
Res15	Reserved Register 15	73 _H	87
Res16	Reserved Register 16	74 _H	87
Res17	Reserved Register 17	75 _H	87
Res18	Reserved Register 18	76 _H	87
Res19	Reserved Register 19	77 _H	87
Res20	Reserved Register 20	78 _H	87
Res21	Reserved Register 21	79 _H	88
Res22	Reserved Register 22	7A _H	88
Res23	Reserved Register 23	7B _H	88
Res24	Reserved Register 24	7C _H	88
Res25	Reserved Register 25	7D _H	88
Res26	Reserved Register 26	7E _H	88
Res27	Reserved Register 27	7F _H	88
Res28	Reserved Register 28	80 _H	88
Res29	Reserved Register 29	81 _H	88
Res30	Reserved Register 30	82 _H	88
Res31	Reserved Register 31	83 _H	88
Res32	Reserved Register 32	84 _H	88
Res33	Reserved Register 33	85 _H	88
Res34	Reserved Register 34	86 _H	88
Res35	Reserved Register 35	87 _H	88
Res36	Reserved Register 36	88 _H	88
Res37	Reserved Register 37	89 _H	88
Res38	Reserved Register 38	8A _H	88
Res39	Reserved Register 39	8B _H	88
TUF0	TCP/UDP Filter 0	8C _H	125
TUF1	TCP/UDP Filter 1	8D _H	125
TUF2	TCP/UDP Filter 2	8E _H	125
TUF3	TCP/UDP Filter 3	8F _H	125
TUF4	TCP/UDP Filter 4	90 _H	125
TUF5	TCP/UDP Filter 5	91 _H	125
TUF6	TCP/UDP Filter 6	92 _H	125

16 Bits Mode Registers Description

Table 34 Registers Overview (cont'd)

Register Short Name	Register Long Name	Offset Address	Page Number
TUF7	TCP/UDP Filter 7	93 _H	125
TFA	Type Filter Action	94 _H	126
PFA	Protocol Filter Action	95 _H	126
TUA0	TCP/UDP Action 0	96 _H	127
TUA1	TCP/UDP Action 1	97 _H	128
TUA2	TCP/UDP Action 2	98 _H	129
Res40	Reserved Register 40	99 _H	88
IE	Interrupt Enable Register	9A _H	130
IS	Interrupt Status Register	9B _H	130
Res41	Reserved Register 41	9C _H	88
CI0	Chip Identifier 0	A0 _H	131
CI1	Chip Identifier 1	A1 _H	131
PS0	Port Status 0	A2 _H	132
PS1	Port Status 1	A3 _H	133
PS2	Port Status 2	A4 _H	134
Res42	Reserved Register 42	A5 _H	88
Res43	Reserved Register 43	A6 _H	88
Res44	Reserved Register 44	A7 _H	88
CL0	Port 0 Receive Packet Counter Low	A8 _H	134
CH0	Port 0 Receive Packet Counter High	A9 _H	136
CL1	Port 1 Receive Packet Counter Low	AC _H	135
CH1	Port 1 Receive Packet Counter High	AD _H	136
CL2	Port 2 Receive Packet Counter Low	B0 _H	135
CH2	Port 2 Receive Packet Counter High	B1 _H	136
CL3	Port 3 Receive Packet Counter Low	B4 _H	135
CH3	Port 3 Receive Packet Counter High	B5 _H	136
CL4	Port 4 Receive Packet Counter Low	B6 _H	135
CH4	Port 4 Receive Packet Counter High	B7 _H	136
CL5	Port 5 Receive Packet Counter Low	B8 _H	135
CH5	Port 5 Receive Packet Counter High	B9 _H	136
CL6	Port 0 Receive Packet Byte Count Low	BA _H	135
CH6	Port 0 Receive Packet Byte Count High	BB _H	136
CL7	Port 1 Receive Packet Byte Count Low	BE _H	135
CH7	Port 1 Receive Packet Byte Count High	BF _H	136
CL8	Port 2 Receive Packet Byte Count Low	C2 _H	135
CH8	Port 2 Receive Packet Byte Count High	C3 _H	136
CL9	Port 3 Receive Packet Byte Count Low	C6 _H	135
CH9	Port 3 Receive Packet Byte Count High	C7 _H	136
CL10	Port 4 Receive Packet Byte Count Low	C8 _H	135
CH10	Port 4 Receive Packet Byte Count High	C9 _H	136
CL11	Port 5 Receive Packet Byte Count Low	CA _H	135

Table 34 Registers Overview (cont'd)

Register Short Name	Register Long Name	Offset Address	Page Number
CH11	Port 5 Receive Packet Byte Count High	CB _H	136
CL12	Port 0 Transmit Packet Count Low	CC _H	135
CH12	Port 0 Transmit Packet Count High	CD _H	136
CL13	Port 1 Transmit Packet Count Low	D0 _H	135
CH13	Port 1 Transmit Packet Count High	D1 _H	136
CL14	Port 2 Transmit Packet Count Low	D4 _H	135
CH14	Port 2 Transmit Packet Count High	D5 _H	136
CL15	Port 3 Transmit Packet Count Low	D8 _H	135
CH15	Port 3 Transmit Packet Count High	D9 _H	137
CL16	Port 4 Transmit Packet Count Low	DA _H	135
CH16	Port 4 Transmit Packet Count High	DB _H	137
CL17	Port 5 Transmit Packet Count Low	DC _H	135
CH17	Port 5 Transmit Packet Count High	DD _H	137
CL18	Port 0 Transmit Packet Byte Count Low	DE _H	135
CH18	Port 0 Transmit Packet Byte Count High	DF _H	137
CL19	Port 1 Transmit Packet Byte Count Low	E2 _H	135
CH19	Port 1 Transmit Packet Byte Count High	E3 _H	137
CL20	Port 2 Transmit Packet Byte Count Low	E6 _H	135
CH20	Port 2 Transmit Packet Byte Count High	E7 _H	137
CL21	Port 3 Transmit Packet Byte Count Low	EA _H	135
CH21	Port 3 Transmit Packet Byte Count High	EB _H	137
CL22	Port 4 Transmit Packet Byte Count Low	EC _H	135
CH22	Port 4 Transmit Packet Byte Count High	ED _H	137
CL23	Port 5 Transmit Packet Byte Count Low	EE _H	135
CH23	Port 5 Transmit Packet Byte Count High	EF _H	137
CL24	Port 0 Collision Count Low	F0 _H	135
CH24	Port 0 Collision Count High	F1 _H	137
CL25	Port 1 Collision Count Low	F4 _H	135
CH25	Port 1 Collision Count High	F5 _H	137
CL26	Port 2 Collision Count Low	F8 _H	135
CH26	Port 2 Collision Count High	F9 _H	137
CL27	Port 3 Collision Count Low	FC _H	135
CH27	Port 3 Collision Count High	FD _H	137
CL28	Port 4 Collision Count Low	FE _H	135
CH28	Port 4 Collision Count High	FF _H	137
CL29	Port 5 Collision Count Low	100 _H	135
CH29	Port 5 Collision Count High	101 _H	137
CL30	Port 0 Error Count Low	102 _H	136
CH30	Port 0 Error Count High	103 _H	137
CL31	Port 1 Error Count Low	106 _H	136
CH31	Port 1 Error Count High	107 _H	137

Table 34 Registers Overview (cont'd)

Register Short Name	Register Long Name	Offset Address	Page Number
CL32	Port 2 Error Count Low	10A _H	136
CH32	Port 2 Error Count High	10B _H	137
CL33	Port 3 Error Count Low	10E _H	136
CH33	Port 3 Error Count High	10F _H	137
CL34	Port 4 Error Count Low	110 _H	136
CH34	Port 4 Error Count High	111 _H	137
CL35	Port 5 Error Count Low	112 _H	136
CH35	Port 5 Error Count High	113 _H	137
OFF0	Over-Flow Flag 0	114 _H	137
OFF1	Over-Flow Flag 1	115 _H	138
OFF2	Over-Flow Flag 2	116 _H	139
OFF3	Over-Flow Flag 3	117 _H	140
OFF4	Over-Flow Flag 4	118 _H	140
OFF5	Over-Flow Flag 5	119 _H	141
HSL	Hardware Setting Low Register	130 _H	142
HSH	Hardware Setting High Register	131 _H	142
Res45	Reserved Register 45	132 _H	88
Res46	Reserved Register 46	133 _H	88
Res47	Reserved Register 47	134 _H	88
AO	Assign Option Register	135 _H	143
Res48	Reserved Register 48	136 _H	88
Res49	Reserved Register 49	137 _H	88
SVP	Security Violation Port	138 _H	144
SS0	Security Status 0	139 _H	144
SS1	Security Status 1	13A _H	145
FLAS	First Lock Address Search	13B _H	145
FLA1	First Lock Address [15:0]	13C _H	146
FLA2	First Lock Address [31:16]	13D _H	146
FLA3	First Lock Address [47:32]	13E _H	146
FLF	First Lock FID	13F _H	147
CCL	Counter Control Low Register	140 _H	147
Res50	Reserved Register 50	141 _H	88
CSL	Counter Status Low Register	142 _H	148
CSH	Counter Status High Register	143 _H	148
PHY_C0	PHY Control Register of Port 0	200 _H	148
PHY_S0	PHY Status Register of Port 0	201 _H	151
PHY_I0_A	PHY Identifier Register of Port 0 (A)	202 _H	152
PHY_I0_B	PHY Identifier Register of Port 0 (B)	203 _H	153
ANAP0	Auto Negotiation Advertisement Register of Port 0	204 _H	154
ANLPA0	Auto Negotiation Link Partner Ability Register of Port 0	205 _H	155

16 Bits Mode Registers Description

Table 34 Registers Overview (cont'd)

Register Short Name	Register Long Name	Offset Address	Page Number
ANE0	Auto Negotiation Expansion Register of Port 0	206 _H	156
NPT0	Next Page Transmit Register of Port 0	207 _H	157
LPNP0	Link Partner Next Page Register of Port 0	208 _H	158
PHY_C1	PHY Control Register of Port 1	220 _H	150
PHY_S1	PHY Status Register of Port 1	221 _H	152
PHY_I1_A	PHY Identifier Register of Port 1 (A)	222 _H	153
PHY_I1_B	PHY Identifier Register of Port 1 (B)	223 _H	153
ANAP1	Auto Negotiation Advertisement Register of Port 1	224 _H	155
ANLPA1	Auto Negotiation Link Partner Ability Register of Port 1	225 _H	156
ANE1	Auto Negotiation Expansion Register of Port 1	226 _H	157
NPT1	Next Page Transmit Register of Port 1	227 _H	158
LPNP1	Link Partner Next Page Register of Port 1	228 _H	159
PHY_C2	PHY Control Register of Port 2	240 _H	150
PHY_S2	PHY Status Register of Port 2	241 _H	152
PHY_I2_A	PHY Identifier Register of Port 2 (A)	242 _H	153
PHY_I2_B	PHY Identifier Register of Port 2 (B)	243 _H	153
ANAP2	Auto Negotiation Advertisement Register of Port 2	244 _H	155
ANLPA2	Auto Negotiation Link Partner Ability Register of Port 2	245 _H	156
ANE2	Auto Negotiation Expansion Register of Port 2	246 _H	157
NPT2	Next Page Transmit Register of Port 2	247 _H	158
LPNP2	Link Partner Next Page Register of Port 2	248 _H	159
PHY_C3	PHY Control Register of Port 3	260 _H	150
PHY_S3	PHY Status Register of Port 3	261 _H	152
PHY_I3_A	PHY Identifier Register of Port 3 (A)	262 _H	153
PHY_I3_B	PHY Identifier Register of Port 3 (B)	263 _H	154
ANAP3	Auto Negotiation Advertisement Register of Port 3	264 _H	155
ANLPA3	Auto Negotiation Link Partner Ability Register of Port 3	265 _H	156
ANE3	Auto Negotiation Expansion Register of Port 3	266 _H	157
NPT3	Next Page Transmit Register of Port 3	267 _H	158
LPNP3	Link Partner Next Page Register of Port 3	268 _H	159
PHY_C4	PHY Control Register of Port 4	280 _H	150
PHY_S4	PHY Status Register of Port 4	281 _H	152
PHY_I4_A	PHY Identifier Register of Port 4 (A)	282 _H	153
PHY_I4_B	PHY Identifier Register of Port 4 (B)	283 _H	154
ANAP4	Auto Negotiation Advertisement Register of Port 4	284 _H	155
ANLPA4	Auto Negotiation Link Partner Ability Register of Port 4	285 _H	156
ANE4	Auto Negotiation Expansion Register of Port 4	286 _H	157

16 Bits Mode Registers Description

Table 34 Registers Overview (cont'd)

Register Short Name	Register Long Name	Offset Address	Page Number
NPT4	Next Page Transmit Register of Port 4	287 _H	158
LPNP4	Link Partner Next Page Register of Port 4	288 _H	159

The register is addressed wordwise.

Table 35 Register Access Types

Mode	Symbol	Description HW	Description SW
read/write	rw	Register is used as input for the HW	Register is read and writable by SW
read	r	Register is written by HW (register between input and output -> one cycle delay)	Value written by software is ignored by hardware; that is, software may write any value to this field without affecting hardware behavior (= Target for development.)
Read only	ro	Register is set by HW (register between input and output -> one cycle delay)	SW can only read this register
Read virtual	rv	Physically, there is no new register, the input of the signal is connected directly to the address multiplexer.	SW can only read this register
Latch high, self clearing	lhsc	Latch high signal at high level, clear on read	SW can read the register
Latch low, self clearing	llsc	Latch high signal at low-level, clear on read	SW can read the register
Latch high, mask clearing	lhmk	Latch high signal at high level, register cleared with written mask	SW can read the register, with write mask the register can be cleared (1 clears)
Latch low, mask clearing	llmk	Latch high signal at low-level, register cleared on read	SW can read the register, with write mask the register can be cleared (1 clears)
Interrupt high, self clearing	ihsc	Differentiate the input signal (low->high) register cleared on read	SW can read the register
Interrupt low, self clearing	ilsc	Differentiate the input signal (high->low) register cleared on read	SW can read the register
Interrupt high, mask clearing	ihmk	Differentiate the input signal (high->low) register cleared with written mask	SW can read the register, with write mask the register can be cleared
Interrupt low, mask clearing	ilmk	Differentiate the input signal (low->high) register cleared with written mask	SW can read the register, with write mask the register can be cleared
Interrupt enable register	ien	Enables the interrupt source for interrupt generation	SW can read and write this register
latch_on_reset	lor	rw register, value is latched after first clock cycle after reset	Register is read and writable by SW
Read/write self clearing	rwsc	Register is used as input for the hw, the register will be cleared due to a HW mechanism.	Writing to the register generates a strobe signal for the HW (1 pdi clock cycle) Register is read and writable by SW.

Table 36 Registers Clock Domains

Clock Short Name	Description
-	-

5.1 EEPROM Basic Registers

Signature Register

SIG	Offset	Reset Value
Signature Register	00 _H	4154 _H

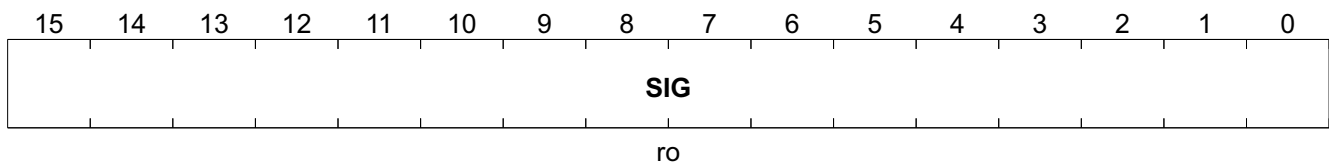

Field	Bits	Type	Description
SIG	15:0	ro	Signature The value must be 4154 _H . ADM6996LC/LCX/LHX uses this value to check if the EEPROM is attached. If the value in the EEPROM does not equal to 4154 _H , ADM6996LC/LCX/LHX will stop loading the EEPROM even if the EEPROM is attached. ADM6996LC/LCX/LHX will use the default value to initialize.

P0 Basic Control Register

P0BC	Offset	Reset Value
P0 Basic Control Register	01 _H	040F _H

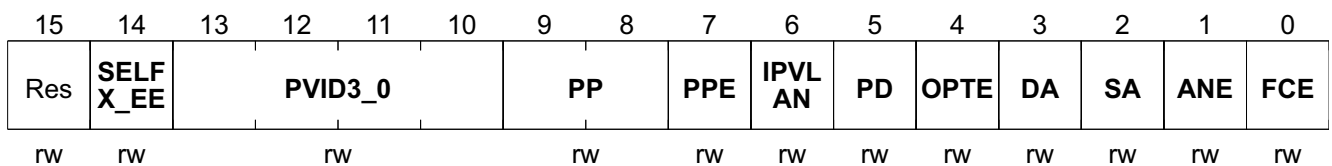

Field	Bits	Type	Description
Res	15	rw	Reserved
SELF_X_EE	14	rw	Select FX This bit is used together with the value (p4fx_hw) on the pin P4FX during the power on reset to decide if the PHY operates on the fiber mode. This bit is useless in Port 5. Port 0, 1, 2, 3: selfx_ee Description Port 4: {p4fx_hw, selfx_ee} Description 1x _B Port 4: Port 4 will operate in the fiber mode 00 _B Port 4: Port 4 will operate in the twisted mode 01 _B Port 4: Port 4 will operate in the fiber mode

16 Bits Mode Registers Description

Field	Bits	Type	Description
PVID3_0	13:10	rw	Private VID See 0028 _H ~ 002C _H to find the other PVID [11:4]
PP	9:8	rw	Port Priority 00 _B Assign packets to Queue 0 01 _B Assign packets to Queue 1 10 _B Assign packets to Queue 2 11 _B Assign packets to Queue 3
PPE	7	rw	Port Priority Enable 0 _B The port priority is disabled 1 _B The port priority is enabled
IPVLAN	6	rw	IP over VLAN PRI 0 _B Use the priority bits in the tag header to assign the priority queue 1 _B Use the IP PRI to assign the priority queue
PD	5	rw	Port Disable 0 _B Port 0, 1, 2, 3, 4: PHY work s normally. Port 5: Port 5 works normally 1 _B Port 0, 1, 2, 3, 4. PHY is disabled. Port 5: Port 5 is forced to link down
OPTE	4	rw	Output Packet Tagging Enable 0 _B Untagged packets are transmitted 1 _B Tagged packets are transmitted
DA	3	rw	Duplex Ability It is useless in Port 5. 0 _B Recommend PHY to work in the half duplex mode 1 _B Recommend PHY to work in the full duplex mode
SA	2	rw	Speed Ability 0 _B Recommend PHY to work in the 10M mode 1 _B Recommend PHY to work in the 100M mode
ANE	1	rw	Auto Negotiation Enable 0 _B Recommend PHY to work without Auto Negotiation 1 _B Recommend PHY to work with Auto Negotiation, when the value on the pin DUPCOL0 during the power on reset is 1
FCE	0	rw	Flow Control Enable 0 _B Recommend MAC to work without Pause or Back Pressure 1 _B In full duplex, recommend MAC to work with Pause when the value on the TXD0 during the power on reset is 1. In half duplex, recommend MAC to work with Back Pressure when the value on the DUPCOL2 during the power on reset is 1

Similar Registers

Table 37 Basic Control Registers 1 to 5

Register Short Name	Register Long Name	Offset Address	Page Number
P1	Basic Control Register 1	03 _H	
P2	Basic Control Register 2	05 _H	
P3	Basic Control Register 3	07 _H	

16 Bits Mode Registers Description

Table 37 Basic Control Registers 1 to 5 (cont'd)

Register Short Name	Register Long Name	Offset Address	Page Number
P4	Basic Control Register 4	08 _H	
P5	Basic Control Register 5	09 _H	

Reserved Register 0

Res0	Offset	Reset Value
Reserved Register 0	02 _H	0000 _H

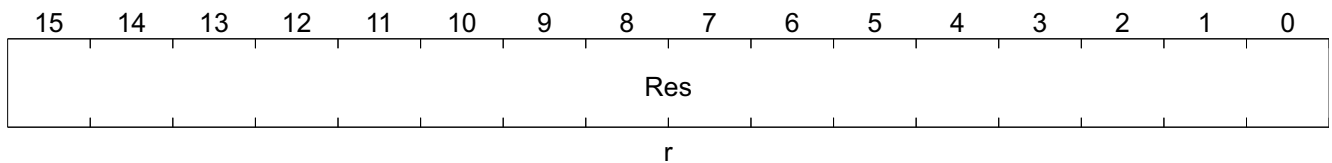

Field	Bits	Type	Description
Res	15:0	r	Reserved

Similar Registers

Table 38 Reserved Registers

Register Short Name	Register Long Name	Offset Address	Page Number
Res1	Reserved Register 1	04 _H	
Res2	Reserved Register 2	06 _H	
Res3	Reserved Register 3	0C _H	
Res4	Reserved Register 4	0D _H	
Res5	Reserved Register 5	23 _H	
Res6	Reserved Register 6	24 _H	
Res7	Reserved Register 7	3F _H	
Res8	Reserved Register 8	6C _H	
Res9	Reserved Register 9	6D _H	
Res10	Reserved Register 10	6E _H	
Res11	Reserved Register 11	6F _H	
Res12	Reserved Register 12	70 _H	
Res13	Reserved Register 13	71 _H	
Res14	Reserved Register 14	72 _H	
Res15	Reserved Register 15	73 _H	
Res16	Reserved Register 16	74 _H	
Res17	Reserved Register 17	75 _H	
Res18	Reserved Register 18	76 _H	
Res19	Reserved Register 19	77 _H	
Res20	Reserved Register 20	78 _H	

16 Bits Mode Registers Description

Table 38 Reserved Registers (cont'd)

Register Short Name	Register Long Name	Offset Address	Page Number
Res21	Reserved Register 21	79 _H	
Res22	Reserved Register 22	7A _H	
Res23	Reserved Register 23	7B _H	
Res24	Reserved Register 24	7C _H	
Res25	Reserved Register 25	7D _H	
Res26	Reserved Register 26	7E _H	
Res27	Reserved Register 27	7F _H	
Res28	Reserved Register 28	80 _H	
Res29	Reserved Register 29	81 _H	
Res30	Reserved Register 30	82 _H	
Res31	Reserved Register 31	83 _H	
Res32	Reserved Register 32	84 _H	
Res33	Reserved Register 33	85 _H	
Res34	Reserved Register 34	86 _H	
Res35	Reserved Register 35	87 _H	
Res36	Reserved Register 36	88 _H	
Res37	Reserved Register 37	89 _H	
Res38	Reserved Register 38	8A _H	
Res39	Reserved Register 39	8B _H	
Res40	Reserved Register 40	99 _H	
Res41	Reserved Register 41	9C _H	
Res42	Reserved Register 42	A5 _H	
Res43	Reserved Register 43	A6 _H	
Res44	Reserved Register 44	A7 _H	
Res45	Reserved Register 45	132 _H	
Res46	Reserved Register 46	133 _H	
Res47	Reserved Register 47	134 _H	
Res48	Reserved Register 48	136 _H	
Res49	Reserved Register 49	137 _H	
Res50	Reserved Register 50	141 _H	

System Control Register 0

SC0 **Offset** **Reset Value**
System Control Register 0 **0A_H** **5902_H**

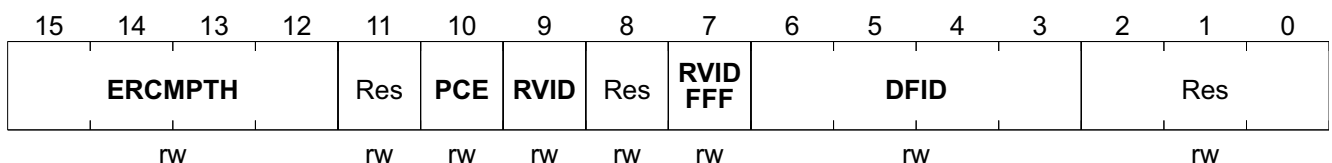

16 Bits Mode Registers Description

Field	Bits	Type	Description
ERCMPH	15:12	rw	Earlier Cycles for Transmission It means the earlier cycles for transmission used in ADM6996LC/LCX/LHX. It is for the engineer debug purpose.
Res	11	rw	Reserved
PCE	10	rw	Priority Change Enable 0 _B Do not change the priority in the tag header 1 _B Change the priority field in the tag header
RVID	9	rw	Replace VID0 and VID1 0 _B Do not replace 1 _B Replace
Res	8	rw	Reserved
RVIDFFF	7	rw	Replace VIDFFF Always Drop
DFID	6:3	rw	Default FID Always 0000 _B
Res	2:0	rw	Reserved

System Control Register 1

SC1 **Offset**
0B_H
System Control Register 1 **Reset Value**
8001_H

15	14	13	12	11	10	9	8	7	6	5	4	3	2	1	0
DFEFD	IF			Res			CMS	TE	TSIE			Res			NE
rw	rw			rw			rw	rw	rw			rw			rw

Field	Bits	Type	Description
DFEFD	15	rw	Disable Far-End-Fault Detection 0 _B Far-End-Fault detect ion is enabled 1 _B Far-End-Fault detect ion is disabled
IF	14	rw	Input Filter 0 _B Discard packets directly when storming or the lack of input buffers 1 _B Forward packets to the un-congested port when storming or the lack of input buffers
Res	13:9	rw	Reserved
CMS	8	rw	Carrier Mask Select 0 _B Mask CRS of 4 Cycles 1 _B Mask CRS of 5 Cycles
TE	7	rw	Port 3 and Port 4 Trunk Enable 0 _B No trunk is enabled 1 _B Port 3 and Port 4 are trunked

16 Bits Mode Registers Description

Field	Bits	Type	Description
TSIE	6	rw	Transmit Short IPG Enable 0 _B 96 bits time is used 1 _B 88/96 bits time is used
Res	5:1	rw	Reserved
NE	0	rw	New EEPROM 0 _B Use old EEPROM functions 1 _B New EEPROM function is enabled

VLAN Priority Map Register

VPM **Offset** **Reset Value**
VLAN Priority Map Register **0E_H** **FA50_H**

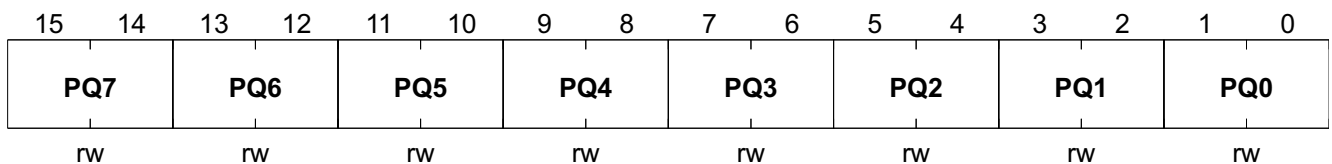

Field	Bits	Type	Description
PQ7	15:14	rw	Priority Queue 7 These 2 bits are used as the priority queue when the tagged packets with the user priority = 111 _B are received on the port. 00 _B Queue 0 01 _B Queue 1 10 _B Queue 2 11 _B Queue 3
PQ6	13:12	rw	Priority Queue 6 These 2 bits are used as the priority queue when the tagged packets with the user priority = 110 _B are received on the port.
PQ5	11:10	rw	Priority Queue 5 These 2 bits are used as the priority queue when the tagged packets with the user priority = 101 _B are received on the port.
PQ4	9:8	rw	Priority Queue 4 These 2 bits are used as the priority queue when the tagged packets with the user priority = 100 _B are received on the port.
PQ3	7:6	rw	Priority Queue 3 These 2 bits are used as the priority queue when the tagged packets with the user priority = 011 _B are received on the port.
PQ2	5:4	rw	Priority Queue 2 These 2 bits are used as the priority queue when the tagged packets with the user priority = 010 _B are received on the port.
PQ1	3:2	rw	Priority Queue 1 These 2 bits are used as the priority queue when the tagged packets with the user priority = 001 _B are received on the port.

16 Bits Mode Registers Description

Field	Bits	Type	Description
PQ0	1:0	rw	Priority Queue 0 These 2 bits are used as the priority queue when the tagged packets with the user priority = 000 _B are received on the port.

TOS Priority Map Register

TPM **Offset** **Reset Value**
TOS Priority Map Register **0F_H** **FA50_H**

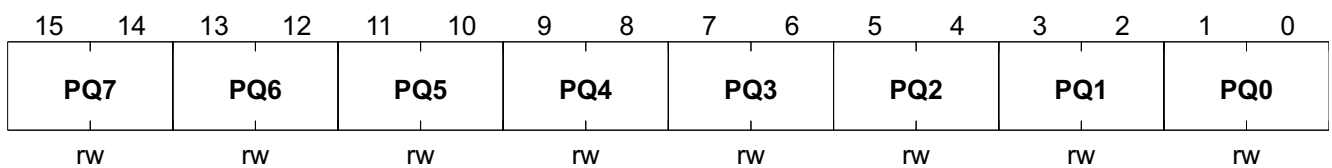

Field	Bits	Type	Description
PQ7	15:14	rw	Priority Queue 7 These 2 bits are used as the priority queue, when the most significant 3 bits in the TOS field are 111 _B 00 _B Queue 0 01 _B Queue 1 10 _B Queue 2 11 _B Queue 3
PQ6	13:12	rw	Priority Queue 6 These 2 bits are used as the priority queue, when the most significant 3 bits in the TOS field are 110 _B
PQ5	11:10	rw	Priority Queue 5 These 2 bits are used as the priority queue, when the most significant 3 bits in the TOS field are 101 _B
PQ4	9:8	rw	Priority Queue 4 These 2 bits are used as the priority queue, when the most significant 3 bits in the TOS field are 100 _B
PQ3	7:6	rw	Priority Queue 3 These 2 bits are used as the priority queue, when the most significant 3 bits in the TOS field are 011 _B
PQ2	5:4	rw	Priority Queue 2 These 2 bits are used as the priority queue, when the most significant 3 bits in the TOS field are 010 _B
PQ1	3:2	rw	Priority Queue 1 These 2 bits are used as the priority queue, when the most significant 3 bits in the TOS field are 001 _B
PQ0	1:0	rw	Priority Queue 0 These 2 bits are used as the priority queue, when the most significant 3 bits in the TOS field are 000 _B

16 Bits Mode Registers Description

System Control Register 2

SC2 **Offset**
System Control Register 2 **10_H** **Reset Value**
0040_H

15	14	13	12	11	10	9	8	7	6	5	4	3	2	1	0
Res								AD	CC	MP	CCD	BD	SE	ST	
rw								rw	rw	rw	rw	rw	rw	rw	

Field	Bits	Type	Description
Res	15:8	rw	Reserved
AD	7	rw	Aging Disable Useless in ADM6996LC/LCX/LHX 0 _B Age enable 1 _B Age disable
CC	6	rw	Rx Clock Change to Tx Clock for GPSI Interface 0 _B ADM6996LC/LCX/LHX does not use Tx clock to replace Rx clock when Rx clock stops. 1 _B ADM6996LC/LCX/LHX uses Tx clock to replace Rx clock when Rx clock stops
MP	5	rw	Multicast Packet Counted into the Storm Counter 0 _B Only broadcast packets are counted into the storming counter 1 _B Multicast and broadcast packets are counted into the storming counter
CCD	4	rw	CRC Check Disable 0 _B Check CRC 1 _B Do not check CRC
BD	3	rw	Back Off Disable 0 _B Back-off is enabled 1 _B Back-off is disabled
SE	2	rw	Storming Enable It is used in ADM6996L/F style storm control. 0 _B Disable broadcast/multicast storm protection. 1 _B Enable broadcast/multicast storm protection.
ST	1:0	rw	Storming Threshold[1:0] It is used in ADM6996L/F style storm control.

System Control Register 3

SC3 **Offset**
System Control Register 3 **11_H** **Reset Value**
E300_H

16 Bits Mode Registers Description

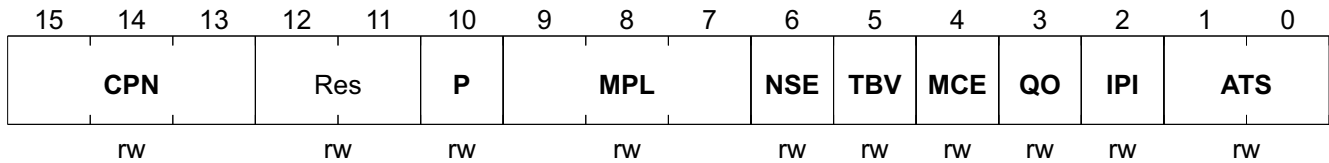

Field	Bits	Type	Description
CPN	15:13	rw	CPU Port Number 000 _B The CPU is attached to Port 0 001 _B The CPU is attached to Port 1 010 _B The CPU is attached to Port 2 011 _B The CPU is attached to Port 3 100 _B The CPU is attached to Port 4 101 _B The CPU is attached to Port 5 111 _B No CPU exists
Res	12:11	rw	Reserved
P	10	rw	Pause Also add s Speci a I Tag when Special TAG Transmit is enabled . 0 _B Do not add Special Tag on the PAUSE packets 1 _B Add Special Tag in the PAUSE packets
MPL	9:7	rw	Max Packet Length 000 _B 1518 bytes 001 _B 1536 bytes 010 _B 1664 bytes 110 _B 1522 bytes x11 _B 1784 bytes 10x _B 1784 bytes
NSE	6	rw	New Storming Enable 0 _B Use the ADM6996L/F style storming control 1 _B Use the ADM6996LC/LCX/LHX style storming control
TBV	5	rw	Tag Base VLAN 0 _B Port VLAN 1 _B Tagged VLAN
MCE	4	rw	MAC Clone Enable 0 _B MAC Clone is disabled 1 _B MAC Clone is enabled
QO	3	rw	Queue Option It ' s the test for the designer in the queue control.
IPI	2	rw	Interrupt Polarity Inverter 0 _B The interrupt signal is active pull low 1 _B The interrupt signal is active pull high
ATS	1:0	rw	Aging Timer Select 00 _B 300 Seconds 01 _B 75 Seconds 10 _B 18 Seconds 11 _B 1 Second

System Control Register 4

SC4 Offset Reset Value
 System Control Register 4 12_H 3600_H

15	14	13	12	11	10	9	8	7	6	5	4	3	2	1	0
DP	DCS	Res	TLE	Res	O5FL	O4FL	O3FL	PI	O2FL	DUAL_CO*	O1FL	LED_ENA [¯]	O0FL		
rw	rw	rw	rw	rw	rw	rw	rw	rw	rw	rw	rw	rw	rw	rw	rw

Field	Bits	Type	Description
DP	15	rw	Drop Packet When Excessive Collision Happen 0 _B Do not drop 1 _B Drop
DCS	14	rw	Duplex and Col Separate 0 _B Indicate the duplex and collision status at the same time 1 _B Indicate the duplex status only
Res	13:12	rw	Reserved
TLE	11	rw	Ten Limit Enable This function works only when Full Flow Control/Half Back Pressure is enabled. 0 _B The switch will not ignore 10 Mbit/s paths even when the ten limit reaches 1 _B The switch will forward packets with Multicast, Broadcast, or Unicast but not learned DA addresses from 100 Mbit/s only to 100 Mbit/s ports and ignore the 10M paths when the ten limit reaches. This function allows the switch to balance the high and the low speed
Res	10:9	rw	Reserved
O5FL	8	rw	OLD P5 First Lock 0 _B First Lock is disabled 1 _B First Lock is enabled
O4FL	7	rw	OLD P4 First Lock 0 _B First Lock is disabled 1 _B First Lock is enabled
O3FL	6	rw	OLD P3 First Lock 0 _B First Lock is disabled 1 _B First Lock is enabled
PI	5	rw	Pause Ignore 0 _B Do not ignore Pause packets 1 _B Ignore Pause packets in half duplex or in full duplex when flow control is not enabled
O2FL	4	rw	OLD P2 First Lock 0 _B First Lock is disabled 1 _B First Lock is enabled

16 Bits Mode Registers Description

Field	Bits	Type	Description
DUAL_COLO R_EE	3	rw	Dual Color in MDC / MDIO with CPU See Chapter 3.23 LED Display for more detail information. 0 _B Single Color 1 _B Dual Color
O1FL	2	rw	OLD P1 First Lock 0 _B First Lock is disabled 1 _B First Lock is enabled
LED_ENABLE	1	rw	LED Enable 0 _B Disable 1 _B Enable
O0FL	0	rw	OLD P0 First Lock 0 _B First Lock is disabled 1 _B First Lock is enabled

Port 0 Security Option

Port Spanning Tree State and Forward Group Port Map.

P0SO **Offset**
Port 0 Security Option **13_H** **Reset Value**
01D5_H

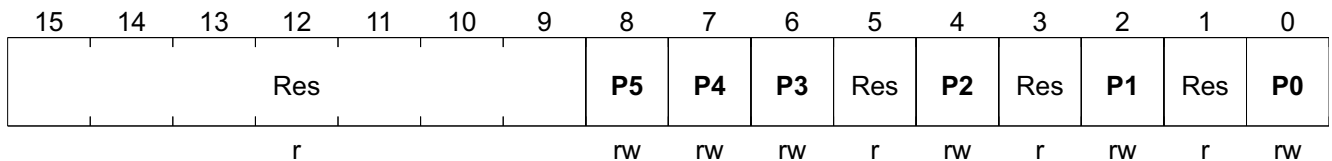

Field	Bits	Type	Description
Res	15:9	r	Reserved
P5	8	rw	Port 5 is a Member of the Forwarding Group 0 _B Port 5 is not a member 1 _B Port 5 is a member
P4	7	rw	Port 4 is a Member of the Forwarding Group 0 _B Port 4 is not a member 1 _B Port 4 is a member
P3	6	rw	Port 3 is a Member of the Forwarding Group 0 _B Port 3 is not a member 1 _B Port 3 is a member
Res	5	r	Reserved
P2	4	rw	Port 2 is a Member of the Forwarding Group 0 _B Port 2 is not a member 1 _B Port 2 is a member
Res	3	r	Reserved
P1	2	rw	Port 1 is a Member of the Forwarding Group 0 _B Port 1 is not a member 1 _B Port 1 is a member
Res	1	r	Reserved

16 Bits Mode Registers Description

Field	Bits	Type	Description
P0	0	rw	Port 0 is a Member of the Forwarding Group 0 _B Port 0 is not a member 1 _B Port 0 is a member

Similar Registers

Table 39 PxSO Registers

Register Short Name	Register Long Name	Offset Address	Page Number
P1SO	Port 1 Security Option	14 _H	
P2SO	Port 2 Security Option	15 _H	
P3SO	Port 3 Security Option	16 _H	
P4SO	Port 4 Security Option	17 _H	
P5SO	Port 5 Security Option	18 _H	

Unicast Port Map and Forward Group Port Map

UFGPM	Offset	Reset Value
Unicast Port Map and Forward Group Port Map	19_H	FFD5_H

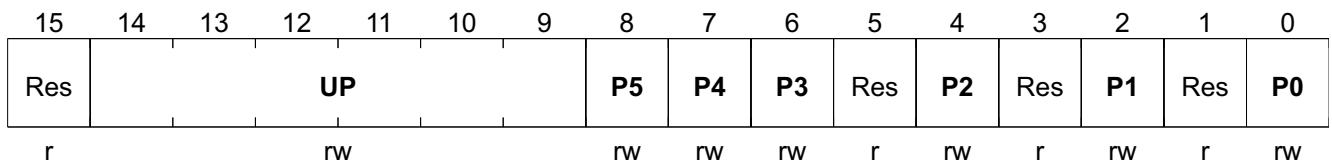

Field	Bits	Type	Description
Res	15	r	Reserved
UP	14:9	rw	Unicast Portmap See Chapter 3.15.2 Packet Forwarding for more detail information.
P5	8	rw	Port 5 is a Member of the Forwarding Group 0 _B Port 5 is not a member 1 _B Port 5 is a member
P4	7	rw	Port 4 is a Member of the Forwarding Group 0 _B Port 4 is not a member 1 _B Port 4 is a member
P3	6	rw	Port 3 is a Member of the Forwarding Group 0 _B Port 3 is not a member 1 _B Port 3 is a member
Res	5	r	Reserved
P2	4	rw	Port 2 is a Member of the Forwarding Group 0 _B Port 2 is not a member 1 _B Port 2 is a member
Res	3	r	Reserved

16 Bits Mode Registers Description

Field	Bits	Type	Description
P1	2	rw	Port 1 is a Member of the Forwarding Group 0 _B Port 1 is not a member 1 _B Port 1 is a member
Res	1	r	Reserved
P0	0	rw	Port 0 is a Member of the Forwarding Group 0 _B Port 0 is not a member 1 _B Port 0 is a member

Broadcast Port Map and Forward Group Port Map

BFGPM **Offset** **Reset Value**
Broadcast Port Map and Forward Group Port Map **1A_H** **FFD5_H**

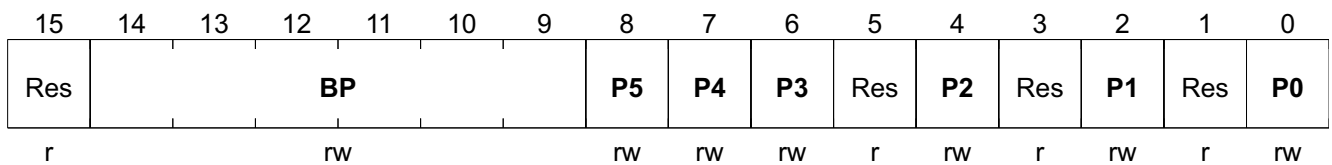

Field	Bits	Type	Description
Res	15	r	Reserved
BP	14:9	rw	Broadcast Portmap Always 111111 _B
P5	8	rw	Port 5 is a Member of the Forwarding Group 0 _B Port 5 is not a member 1 _B Port 5 is a member
P4	7	rw	Port 4 is a Member of the Forwarding Group 0 _B Port 4 is not a member 1 _B Port 4 is a member
P3	6	rw	Port 3 is a Member of the Forwarding Group 0 _B Port 3 is not a member 1 _B Port 3 is a member
Res	5	r	Reserved
P2	4	rw	Port 2 is a Member of the Forwarding Group 0 _B Port 2 is not a member 1 _B Port 2 is a member
Res	3	r	Reserved
P1	2	rw	Port 1 is a Member of the Forwarding Group 0 _B Port 1 is not a member 1 _B Port 1 is a member
Res	1	r	Reserved

16 Bits Mode Registers Description

Field	Bits	Type	Description
P0	0	rw	Port 0 is a Member of the Forwarding Group 0 _B Port 0 is not a member 1 _B Port 0 is a member

Multicast Port Map and Forward Group Port Map

MFGPM **Offset**
Multicast Port Map and Forward Group Port **1B_H**
Map **Reset Value**
FFD5_H

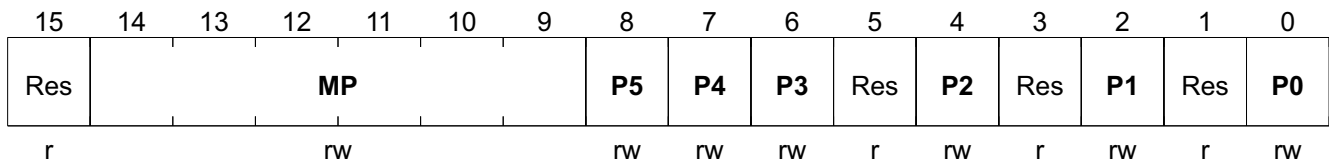

Field	Bits	Type	Description
Res	15	r	Reserved
MP	14:9	rw	Multicast Portmap Always 111111 _B
P5	8	rw	Port 5 is a member of the Forwarding Group 0 _B Port 5 is not a member 1 _B Port 5 is a member
P4	7	rw	Port 4 is a member of the Forwarding Group 0 _B Port 4 is not a member 1 _B Port 4 is a member
P3	6	rw	Port 3 is a member of the Forwarding Group 0 _B Port 3 is not a member 1 _B Port 3 is a member
Res	5	r	Reserved
P2	4	rw	Port 2 is a member of the Forwarding Group 0 _B Port 2 is not a member 1 _B Port 2 is a member
Res	3	r	Reserved
P1	2	rw	Port 1 is a member of the Forwarding Group 0 _B Port 1 is not a member 1 _B Port 1 is a member
Res	1	r	Reserved
P0	0	rw	Port 0 is a member of the Forwarding Group 0 _B Port 0 is not a member 1 _B Port 0 is a member

Reserve Port Map and Forward Group Port Map

16 Bits Mode Registers Description

RFGPM **Offset**
Reserve Port Map and Forward Group Port Map **1C_H** **Reset Value**
FFD5_H

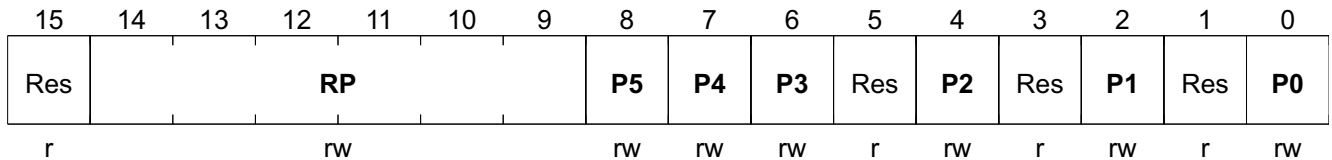

Field	Bits	Type	Description
Res	15	r	Reserved
RP	14:9	rw	Reserve Portmap Always 111111 _B
P5	8	rw	Port 5 is a member of the Forwarding Group 0 _B Port 5 is not a member 1 _B Port 5 is a member
P4	7	rw	Port 4 is a member of the Forwarding Group 0 _B Port 4 is not a member 1 _B Port 4 is a member
P3	6	rw	Port 3 is a member of the Forwarding Group 0 _B Port 3 is not a member 1 _B Port 3 is a member
Res	5	r	Reserved
P2	4	rw	Port 2 is a member of the Forwarding Group 0 _B Port 2 is not a member 1 _B Port 2 is a member
Res	3	r	Reserved
P1	2	rw	Port 1 is a member of the Forwarding Group 0 _B Port 1 is not a member 1 _B Port 1 is a member
Res	1	r	Reserved
P0	0	rw	Port 0 is a member of the Forwarding Group 0 _B Port 0 is not a member 1 _B Port 0 is a member

Packet Identification Option, Forward Group Port Map

PIOFGPM **Offset**
Packet Identification Option, Forward Group Port Map **1D_H** **Reset Value**
FFD5_H

16 Bits Mode Registers Description

15	14	13	12	11	10	9	8	7	6	5	4	3	2	1	0
Res	DIVS	DIIP	Res	DIIP	Res	P5	P4	P3	Res	P2	Res	P1	Res	P0	
rw	rw	rw	rw	rw	rw	rw	rw	rw	r	rw	r	rw	r	rw	

Field	Bits	Type	Description
Res	15	rw	Reserved
DIVS	14	rw	Do not Identify VLAN after SNAP 0 _B Identify 1 _B Do not identify
DIIP	13	rw	Do not Identify IPV6 in PPPOE 0 _B Identify 1 _B Do not identify
Res	12:11	rw	Reserved
DIIP	10	rw	Do not Identify IP in PPPOE 0 _B Identify 1 _B Do not identify
Res	9	rw	Reserved
P5	8	rw	Port 5 is a member of the Forwarding Group 0 _B Port 5 is not a member 1 _B Port 5 is a member
P4	7	rw	Port 4 is a member of the Forwarding Group 0 _B Port 4 is not a member 1 _B Port 4 is a member
P3	6	rw	Port 3 is a member of the Forwarding Group 0 _B Port 3 is not a member 1 _B Port 3 is a member
Res	5	r	Reserved
P2	4	rw	Port 2 is a member of the Forwarding Group 0 _B Port 2 is not a member 1 _B Port 2 is a member
Res	3	r	Reserved
P1	2	rw	Port 1 is a member of the Forwarding Group 0 _B Port 1 is not a member 1 _B Port 1 is a member
Res	1	r	Reserved
P0	0	rw	Port 0 is a member of the Forwarding Group 0 _B Port 0 is not a member 1 _B Port 0 is a member

VLAN Priority Enable and Forward Group Port Map

16 Bits Mode Registers Description

VPEFGPM **Offset**
VLAN Priority Enable and Forward Group **1E_H**
Port Map **Reset Value**
FFD5_H

15	14	13	12	11	10	9	8	7	6	5	4	3	2	1	0
Res	VPE						P5	P4	P3	Res	P2	Res	P1	Res	P0
r	rw						rw	rw	rw	r	rw	r	rw	r	rw

Field	Bits	Type	Description
Res	15	r	Reserved
VPE	14:9	rw	VLAN Priority Enable 0 _B Do not care the PRI in the tag header 1 _B PRI in the tag header will be taken into priority determination consideration
P5	8	rw	Port 5 is a member of the Forwarding Group 0 _B Port 5 is not a member 1 _B Port 5 is a member
P4	7	rw	Port 4 is a member of the Forwarding Group 0 _B Port 4 is not a member 1 _B Port 4 is a member
P3	6	rw	Port 3 is a member of the Forwarding Group 0 _B Port 3 is not a member 1 _B Port 3 is a member
Res	5	r	Reserved
P2	4	rw	Port 2 is a member of the Forwarding Group 0 _B Port 2 is not a member 1 _B Port 2 is a membe
Res	3	r	Reserved
P1	2	rw	Port 1 is a member of the Forwarding Group 0 _B Port 1 is not a member 1 _B Port 1 is a member
Res	1	r	Reserved
P0	0	rw	Port 0 is a member of the Forwarding Group 0 _B Port 0 is not a member 1 _B Port 0 is a member

Service Priority Enable and Forward Group Port Map

SPEFGPM **Offset**
Service Priority Enable and Forward Group **1F_H**
Port Map **Reset Value**
FFD5_H

16 Bits Mode Registers Description

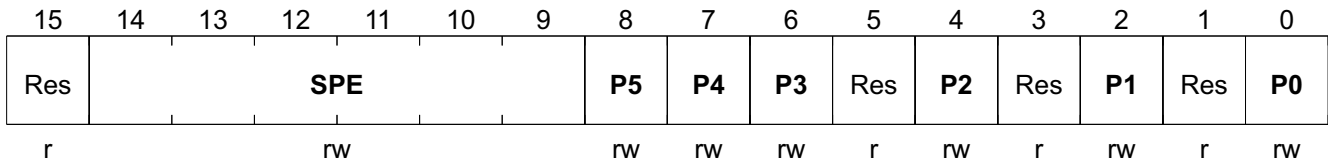

Field	Bits	Type	Description
Res	15	r	Reserved
SPE	14:9	rw	Service Priority Enable 0 _B Don't care IPV4 TOS /IPV6 Traffic Class 1 _B Care IPV4 TOS/IPV6 Traffic for priority decision
P5	8	rw	Port 5 is a member of the Forwarding Group 0 _B Port 5 is not a member 1 _B Port 5 is a member
P4	7	rw	Port 4 is a member of the Forwarding Group 0 _B Port 4 is not a member 1 _B Port 4 is a member
P3	6	rw	Port 3 is a member of the Forwarding Group 0 _B Port 3 is not a member 1 _B Port 3 is a member
Res	5	r	Reserved
P2	4	rw	Port 2 is a member of the Forwarding Group 0 _B Port 2 is not a member 1 _B Port 2 is a member
Res	3	r	Reserved
P1	2	rw	Port 1 is a member of the Forwarding Group 0 _B Port 1 is not a member 1 _B Port 1 is a member
Res	1	r	Reserved
P0	0	rw	Port 0 is a member of the Forwarding Group 0 _B Port 0 is not a member 1 _B Port 0 is a member

Input Force No Tag and Forward Group Port Map?

IFNTFGPM	Offset	Reset Value
Input Force No Tag and Forward Group Port Map	20_H	FFD5_H

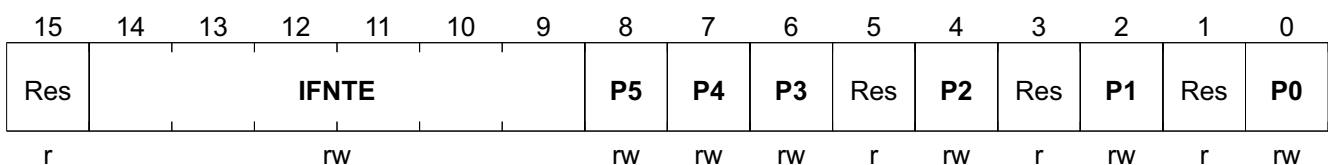

16 Bits Mode Registers Description

Field	Bits	Type	Description
P5	8	rw	Port 5 is a member of the Forwarding Group 0 _B Port 5 is not a member 1 _B Port 5 is a member
P4	7	rw	Port 4 is a member of the Forwarding Group 0 _B Port 4 is not a member 1 _B Port 4 is a member
P3	6	rw	Port 3 is a member of the Forwarding Group 0 _B Port 3 is not a member 1 _B Port 3 is a member
Res	5	r	Reserved
P2	4	rw	Port 2 is a member of the Forwarding Group 0 _B Port 2 is not a member 1 _B Port 2 is a member
Res	3	r	Reserved
P1	2	rw	Port 1 is a member of the Forwarding Group 0 _B Port 1 is not a member 1 _B Port 1 is a member
Res	1	r	Reserved
P0	0	rw	Port 0 is a member of the Forwarding Group 0 _B Port 0 is not a member 1 _B Port 0 is a member

VLAN Security Disable and Forward Group Port Map

VSDFGPM **Offset**
VLAN Security Disable and Forward Group **22_H**
Port Map **Reset Value**
FFD5_H

	15	14	13	12	11	10	9	8	7	6	5	4	3	2	1	0
Res	VSD						P5	P4	P3	Res	P2	Res	P1	Res	P0	
r	rw						rw	rw	rw	r	rw	r	rw	r	rw	

Field	Bits	Type	Description
Res	15	r	Reserved
VSD	14:9	rw	VLAN Security Disable Always 111111 _B
P5	8	rw	Port 5 is a member of the Forwarding Group 0 _B Port 5 is not a member 1 _B Port 5 is a member
P4	7	rw	Port 4 is a member of the Forwarding Group 0 _B Port 4 is not a member 1 _B Port 4 is a member

16 Bits Mode Registers Description

Field	Bits	Type	Description
P3	6	rw	Port 3 is a member of the Forwarding Group 0 _B Port 3 is not a member 1 _B Port 3 is a member
Res	5	r	Reserved
P2	4	rw	Port 2 is a member of the Forwarding Group 0 _B Port 2 is not a member 1 _B Port 2 is a member
Res	3	r	Reserved
P1	2	rw	Port 1 is a member of the Forwarding Group 0 _B Port 1 is not a member 1 _B Port 1 is a member
Res	1	r	Reserved
P0	0	rw	Port 0 is a member of the Forwarding Group 0 _B Port 0 is not a member 1 _B Port 0 is a member

IGMP/MLDTRAP Enable and Input Jam Threshold Register

IMEIJT	Offset	Reset Value
IGMP/MLDTRAP Enable and Input Jam Threshold Register	25_H	1000_H

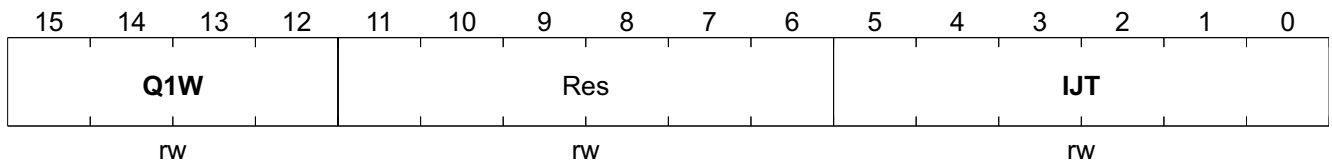

Field	Bits	Type	Description
Q1W	15:12	rw	Queue 1 Weight See Table 32 Priority Queue Weight Ratio for more detail information.
Res	11:6	rw	Reserved
IJT	5:0	rw	Input Jam Threshold

Queue 2 Weight, VID Exist Check, and PPPOE Port Only

Q2WVECPO	Offset	Reset Value
Queue 2 Weight, VID Exist Check, and PPPOE Port Only	26_H	1000_H

16 Bits Mode Registers Description

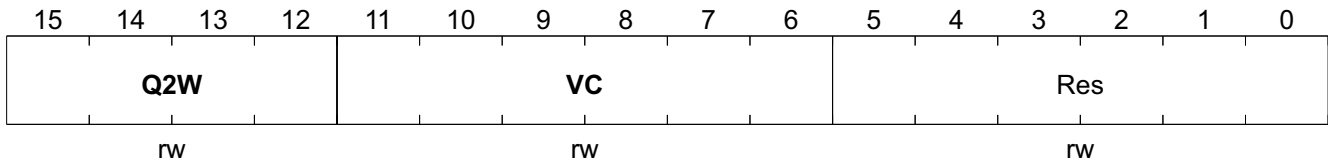

Field	Bits	Type	Description
Q2W	15:12	rw	Queue 2 Weight See Table 32 for more detail information.
VC	11:6	rw	VID Check Always 000000 _B
Res	5:0	rw	Reserved

Queue 3 Weight, Back to Port VLAN, and Admit Only VLAN-Tagged

Q3WBPVAO	Offset	Reset Value
Queue 3 Weight, Back to Port VLAN, and Admit Only VLAN-Tagged	27 _H	1000 _H

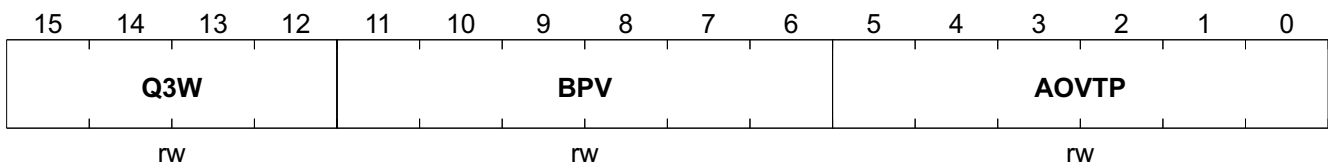

Field	Bits	Type	Description
Q3W	15:12	rw	Queue 3 Weight See Table 32 for more detail information.
BPV	11:6	rw	Back To Port VLAN Always 000000 _B
AOVTP	5:0	rw	Admit Only VLAN_Tagged Packet Always 000000 _B

Input Double Tag Enable, and P0VID[11:4]

IDTEP	Offset	Reset Value
Input Double Tag Enable, and P0VID[11:4]	28 _H	0000 _H

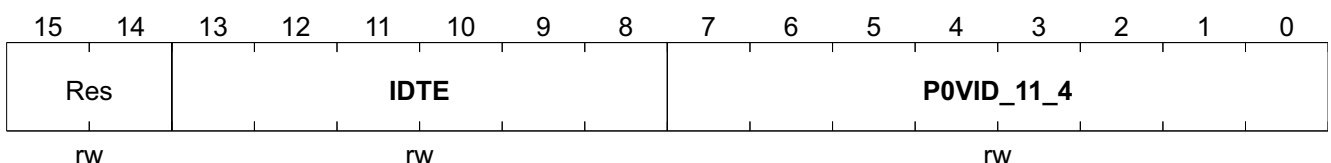

16 Bits Mode Registers Description

Field	Bits	Type	Description
Res	15:14	rw	Reserved
IDTE	13:8	rw	Input Double Tag Enable The register is reserved for internal use only and should be kept 0B
P0VID_11_4	7:0	rw	P0VID[11:4] VID bit 11 ~ 4 fo Port 0

Output Double Tag Enable, and P1VID[11:4]

ODTEP	Offset	Reset Value
Output Double Tag Enable, and P1VID[11:4]	29_H	0000_H

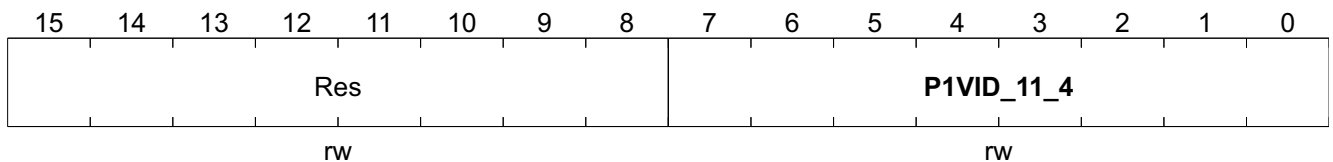

Field	Bits	Type	Description
Res	15:8	rw	Reserved
P1VID_11_4	7:0	rw	P1VID[11:4] VID bit 11 ~ 4 of Port 1.

Output Tag Bypass, and P2VID[11:4]

OTBP	Offset	Reset Value
Output Tag Bypass, and P2VID[11:4]	2A_H	3F00_H

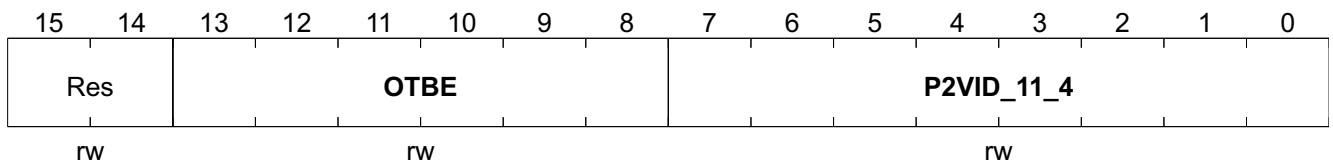

Field	Bits	Type	Description
Res	15:14	rw	Reserved
OTBE	13:8	rw	Output Tag Bypass Enable Always 000000 _B
P2VID_11_4	7:0	rw	P2VID[11:4] VID bit 11 ~ 4 of Port 2.

16 Bits Mode Registers Description

P3VID[11:4], and P4VID[11:4]

P11_4 P3VID[11:4], and P4VID[11:4]	Offset 2B_H	Reset Value 0000_H
---	--	---

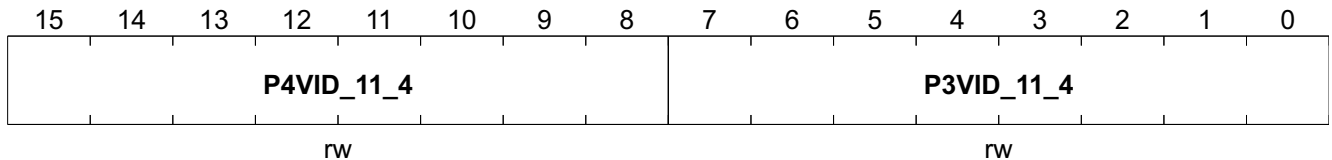

Field	Bits	Type	Description
P4VID_11_4	15:8	rw	P4VID[11:4] VID bit 11 ~ 4 of Port 4.
P3VID_11_4	7:0	rw	P3VID[11:4] VID bit 11 ~ 4 of Port 3.

Reserved Address Control, and P5VID[11:4]

RACP Reserved Address Control, and P5VID[11:4]	Offset 2C_H	Reset Value D000_H
---	--	---

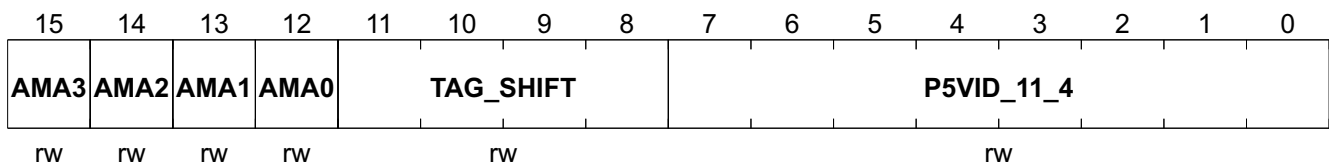

Field	Bits	Type	Description
AMA3	15	rw	Action of MAC Address 3 The Action of MAC Address = 0180C2000010 _H ~ 0180C20000FF _H
AMA2	14	rw	Action of MAC Address 2 The Action of MAC Address = 0180C2000002 _H ~ 0180C200000F _H
AMA1	13	rw	Action of MAC Address 1 The Action of MAC Address = 0180C2000001 _H
AMA0	12	rw	Action of MAC Address 0 The Action of MAC Address = 0180C2000000 _H
TAG_SHIFT	11:8	rw	Tag Shift
P5VID_11_4	7:0	rw	P5VID[11:4] VID bit 11 ~ 4 of Port 5

PHY Control Register

16 Bits Mode Registers Description

PHYC **Offset**
PHY Control Register **2D_H** **Reset Value**
4442_H

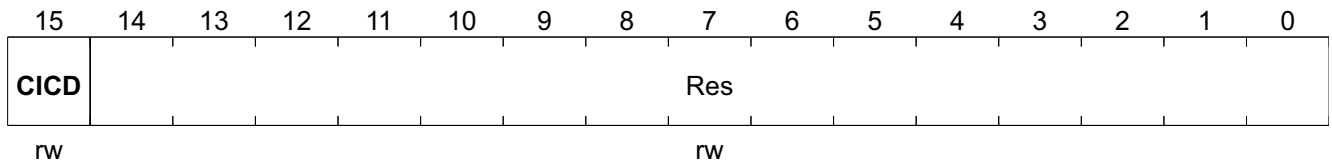

Field	Bits	Type	Description
CICD	15	rw	Chip ID Check Disable 0 _B Check CHIP ID in 32 bit SDC/SDO 1 _B Do not check CHIP ID in 32 bit SDC/SDIO
Res	14:0	rw	Reserved

ADM TAG Ether Type

ATET **Offset**
ADM TAG Ether Type **2E_H** **Reset Value**
0000_H

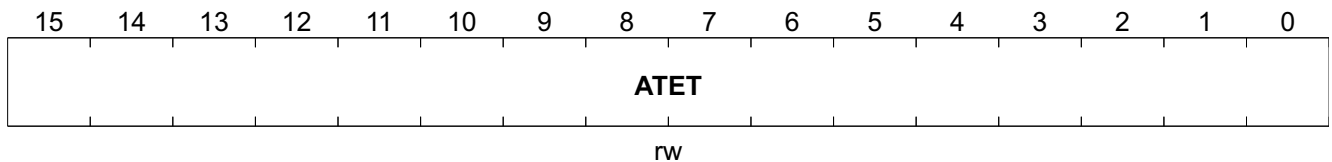

Field	Bits	Type	Description
ATET	15:0	rw	ADM TAG Ether Type This value is used by the user to define their Ether-Type. When Special Tag Receive is enabled, ADM6996LC/LCX/LHX checks the packets on the CPU port to see if the two bytes following the SA are the same as ADM TAG Ether Type . If they are different, ADM6996LC/LCX/LHX bypasses the Special Tag. If the same, ADM6996LC/LCX/LHX will use the value in the Special Tag to do switching decisions .

PHY Restart Register

PR **Offset**
PHY Restart Register **2F_H** **Reset Value**
0000_H

16 Bits Mode Registers Description

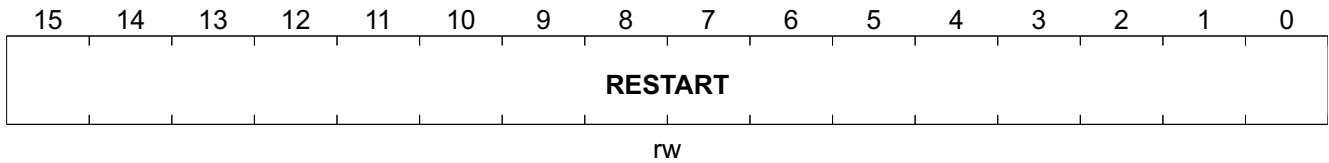

Field	Bits	Type	Description
RESTART	15:0	rw	Restart ADM6996LC/LCX/LHX writes this register to restart all the PHYs in the switch. The value written is not important.

Miscellaneous Register

MISC **Offset**
Miscellaneous Register **30_H** **Reset Value**
0987_H

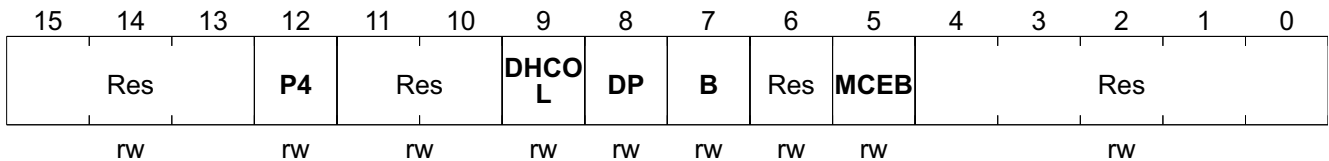

Field	Bits	Type	Description
Res	15:13	rw	Reserved
P4	12	rw	Port 4 LED Mode 0 _B LinkAct/DupCol/Speed. 1 _B Link/Act/Speed.
Res	11:10	rw	Reserved
DHCOL	9	rw	Dual Speed Hub COL_LED Enable 0 _B Normal LED display. 1 _B Dual Speed Hub LED display. Port0 Col LED: 10M Col LED. Port1 Col LED: 100M Col LED.
DP	8	rw	Drop Packets Drop packets when the link partner does not follow the PAUSE protocol. 0 _B Disable. 1 _B Enable to drop packets.
B	7	rw	BYPASS Bypass Tag/Untag function. 0 _B Disable. 1 _B Enable to bypass Tag/Untag function
Res	6	rw	Reserved
MCEB	5	rw	MAC Clone Enable Bits Select 0 _B Select 1 bit MAC Clone function. 1 _B Select 2 bits MAC Clone function.
Res	4:0	rw	Reserved

Basic Bandwidth Control Register 0

BBC0 **Offset**
Basic Bandwidth Control Register 0 **31_H** **Reset Value**
0000_H

15	14	13	12	11	10	9	8	7	6	5	4	3	2	1	0
R3BW_TH1	R3BW_TH0			R2BW_TH1	R2BW_TH0			R1BW_TH1	R1BW_TH0			R0BW_TH1	R0BW_TH0		
rw	rw			rw	rw			rw	rw			rw	rw		

Field	Bits	Type	Description
R3BW_TH1	15	rw	Port 3 Receive Bandwidth Maximum[3]. See register 0033 _H , P3RBCE for more detail.
R3BW_TH0	14:12	rw	Port 3 Receive Bandwidth Configuration See register 0033 _H , P3RBCE for more detail.
R2BW_TH1	11	rw	Port 2 Receive Bandwidth Maximum[3]. See register 0033 _H , P2RBCE for more detail.
R2BW_TH0	10:8	rw	Port 2 Receive Bandwidth Configuration See register 0033 _H , P2RBCE for more detail.
R1BW_TH1	7	rw	Port 1 Receive Bandwidth Maximum[3]. See register 0033 _H , P1RBCE for more detail.
R1BW_TH0	6:4	rw	Port 1 Receive Bandwidth Configuration See register 0033 _H , P1RBCE for more detail.
R0BW_TH1	3	rw	Port 0 Receive Bandwidth Maximum[3]. See register 0033 _H , P0RBCE for more detail.
R0BW_TH0	2:0	rw	Port 0 Receive Bandwidth Configuration See register 0033 _H , P0RBCE for more detail.

Basic Bandwidth Control Register 1

BBC1 **Offset**
Basic Bandwidth Control Register 1 **32_H** **Reset Value**
0000_H

15	14	13	12	11	10	9	8	7	6	5	4	3	2	1	0
T1BW_TH1	T1BW_TH0			T0BW_TH1	T0BW_TH0			R5BW_TH1	R5BW_TH0			R4BW_TH1	R4BW_TH0		
rw	rw			rw	rw			rw	rw			rw	rw		

Field	Bits	Type	Description
T1BW_TH1	15	rw	Port 1 Transmit Bandwidth Maximum[3]. See register 0033 _H , P1TBCE for more detail.

16 Bits Mode Registers Description

Field	Bits	Type	Description
T1BW_TH0	14:12	rw	Port 1 Transmit Bandwidth Maximum[2:0]. See register 0033 _H , P1TBCE for more detail.
T0BW_TH1	11	rw	Port 0 Transmit Bandwidth Maximum[3]. See register 0033 _H , P0TBCE for more detail.
T0BW_TH0	10:8	rw	Port 0 Transmit Bandwidth Maximum[2:0]. See register 0033 _H , P0TBCE for more detail.
R5BW_TH1	7	rw	Port 5 Receive Bandwidth Maximum[3]. See register 0033 _H , P5RBCE for more detail.
R5BW_TH0	6:4	rw	Port 5 Receive Bandwidth Configuration See register 0033 _H , P5RBCE for more detail.
R4BW_TH1	3	rw	Port 4 Receive Bandwidth Maximum[3]. See register 0033 _H , P4RBCE for more detail.
R4BW_TH0	2:0	rw	Port 4 Receive Bandwidth Configuration See register 0033 _H , P4RBCE for more detail.

Bandwidth Control Enable Register

BCE	Offset	Reset Value
Bandwidth Control Enable Register	33_H	0000_H

15	14	13	12	11	10	9	8	7	6	5	4	3	2	1	0
IPCP	CLC	Res	ANBCE	P5TBCE	P4TBCE	P3TBCE	P5RBCE	P4RBCE	P3RBCE	P2TBCE	P2RBCE	P1TBCE	P1RBCE	P0TBCE	P0RBCE
rw	rw	rw	rw	rw	rw	rw	rw	rw	rw	rw	rw	rw	rw	rw	rw

Field	Bits	Type	Description
IPCP	15	rw	Invert P4 Clock in PCS 0 _D Disable 1 _D Enable
CLC	14	rw	Check the Length of CRS 0 _D Enable 1 _D Disable
Res	13	rw	Reserved
ANBCE	12	rw	ADM6996LC/LCX/LHX New Bandwidth Control Enable 0 _B Disable 1 _B Enable
P5TBCE	11	rw	Port 5 Transmit Bandwidth Control Enable The transmit bandwidth is { T5BW_TH3 , T5BW_TH2 , T5BW_TH1 , T5BW_TH0 , 000000 _B } kbit/s. K = 1000. 0 _B Disable 1 _B Enable

16 Bits Mode Registers Description

Field	Bits	Type	Description
P4TBCE	10	rw	Port 4 Transmit Bandwidth Control Enable The transmit bandwidth is { T4BW_TH3, T4BW_TH2, T4BW_TH1, T4BW_TH0 , 000000 _B } kbit/s. K = 1000. 0 _B Disable 1 _B Enable
P3TBCE	9	rw	Port 3 Transmit Bandwidth Control Enable The transmit bandwidth is { T3BW_TH3, T3BW_TH2, T3BW_TH1, T3BW_TH0 , 000000 _B } kbit/s. K = 1000. 0 _B Disable 1 _B Enable
P5RBCE	8	rw	Port 5 Receive Bandwidth Control Enable The receive bandwidth is { R5BW_TH3, R5BW_TH2, R5BW_TH1, R5BW_TH0 , 000000 _B } kbit/s. K = 1000. 0 _B Disable 1 _B Enable
P4RBCE	7	rw	Port 4 Receive Bandwidth Control Enable The receive bandwidth is { R4BW_TH3, R4BW_TH2, R4BW_TH1, R4BW_TH0 , 000000 _B } kbit/s. K = 1000. 0 _B Disable 1 _B Enable
P3RBCE	6	rw	Port 3 Receive Bandwidth Control Enable The receive bandwidth is { R3BW_TH3, R3BW_TH2, R3BW_TH1, R3BW_TH0 , 000000 _B } kbit/s. K = 1000. 0 _B Disable 1 _B Enable
P2TBCE	5	rw	Port 2 Transmit Bandwidth Control Enable The transmit bandwidth is { T2BW_TH3, T2BW_TH2, T2BW_TH1, T2BW_TH0 , 000000 _B } kbit/s. K = 1000. 0 _B Disable 1 _B Enable
P2RBCE	4	rw	Port 2 Receive Bandwidth Control Enable The receive bandwidth is { R2BW_TH3, R2BW_TH2, R2BW_TH1, R2BW_TH0 , 000000 _B } kbit/s. K = 1000. 0 _B Disable 1 _B Enable
P1TBCE	3	rw	Port 1 Transmit Bandwidth Control Enable The transmit bandwidth is { T1BW_TH3, T1BW_TH2, T1BW_TH1, T1BW_TH0 , 000000 _B } kbit/s. K = 1000. 0 _B Disable 1 _B Enable
P1RBCE	2	rw	Port 1 Receive Bandwidth Control Enable The receive bandwidth is { R1BW_TH3, R1BW_TH2, R1BW_TH1, R1BW_TH0 , 000000 _B } kbit/s. K = 1000. 0 _B Disable 1 _B Enable

16 Bits Mode Registers Description

Field	Bits	Type	Description
P0TBCE	1	rw	Port 0 Transmit Bandwidth Control Enable The transmit bandwidth is { T0BW_TH3 , T0BW_TH2 , T0BW_TH1 , T0BW_TH0 , 000000 _B } kbit/s. K = 1000. 0 _B Disable 1 _B Enable
P0RBCE	0	rw	Port 0 Receive Bandwidth Control Enable The receive bandwidth is { R0BW_TH3 , R0BW_TH2 , R0BW_TH1 , R0BW_TH0 , 000000 _B } kbit/s. K = 1000. 0 _B Disable 1 _B Enable

Extended Bandwidth Control Register 0

EBC0	Offset	Reset Value
Extended Bandwidth Control Register 0	34_H	0000_H

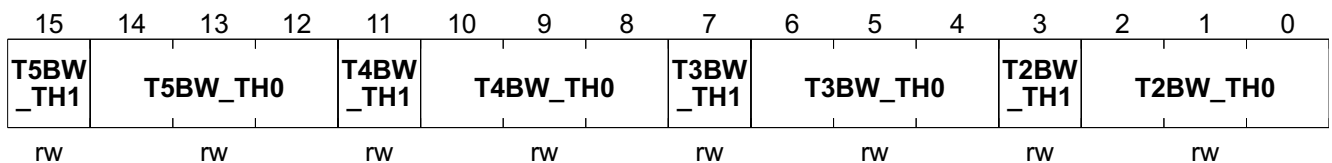

Field	Bits	Type	Description
T5BW_TH1	15	rw	Port 5 Transmit Bandwidth Maximum[3]. See register 0033 _H , P5TBCE for more detail.
T5BW_TH0	14:12	rw	Port 5 Transmit Bandwidth Maximum[2:0]. See register 0033 _H , P5TBCE for more detail.
T4BW_TH1	11	rw	Port 4 Transmit Bandwidth Maximum[3]. See register 0033 _H , P4TBCE for more detail.
T4BW_TH0	10:8	rw	Port 4 Transmit Bandwidth Maximum[2:0]. See register 0033 _H , P4TBCE for more detail.
T3BW_TH1	7	rw	Port 3 Transmit Bandwidth Maximum[3]. See register 0033 _H , P3TBCE for more detail.
T3BW_TH0	6:4	rw	Port 3 Transmit Bandwidth Maximum[2:0]. See register 0033 _H , P3TBCE for more detail.
T2BW_TH1	3	rw	Port 2 Transmit Bandwidth Maximum[3]. See register 0033 _H , P2TBCE for more detail.
T2BW_TH0	2:0	rw	Port 2 Transmit Bandwidth Maximum[2:0]. See register 0033 _H , P2TBCE for more detail.

Extended Bandwidth Control Register 1

16 Bits Mode Registers Description

EBC1 **Offset**
Extended Bandwidth Control Register 1 **35_H** **Reset Value**
0000_H

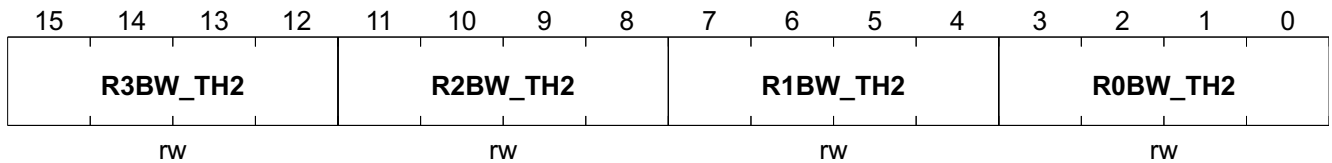

Field	Bits	Type	Description
R3BW_TH2	15:12	rw	Port 3 Receive Bandwidth Maximum[7:4]. See register 0033 _H , P3RBCE for more detail.
R2BW_TH2	11:8	rw	Port 2 Receive Bandwidth Maximum[7:4]. See register 0033 _H , P2RBCE for more detail.
R1BW_TH2	7:4	rw	Port 1 Receive Bandwidth Maximum[7:4]. See register 0033 _H , P1RBCE for more detail.
R0BW_TH2	3:0	rw	Port 0 Receive Bandwidth Maximum[7:4]. See register 0033 _H , P0RBCE for more detail.

Extended Bandwidth Control Register 2

EBC2 **Offset**
Extended Bandwidth Control Register 2 **36_H** **Reset Value**
0000_H

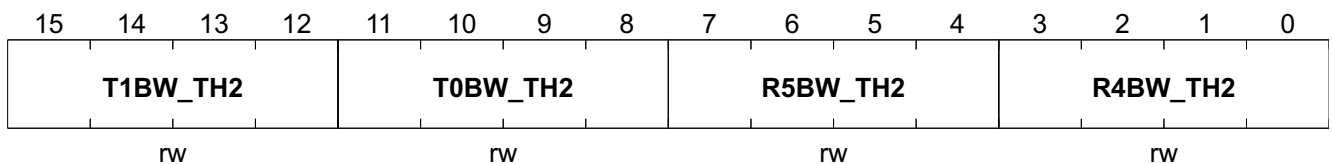

Field	Bits	Type	Description
T1BW_TH2	15:12	rw	Port 1 Transmit Bandwidth Maximum[7:4] See register 0033 _H , P1TBCE for more detail.
T0BW_TH2	11:8	rw	Port 0 Transmit Bandwidth Maximum[7:4]. See register 0033 _H , P0TBCE for more detail.
R5BW_TH2	7:4	rw	Port 5 Receive Bandwidth Maximum[7:4]. See register 0033 _H , P5RBCE for more detail.
R4BW_TH2	3:0	rw	Port 4 Receive Bandwidth Maximum[7:4]. See register 0033 _H , P4RBCE for more detail.

Extended Bandwidth Control Register 3

16 Bits Mode Registers Description

EBC3 **Offset**
Extended Bandwidth Control Register 3 **37_H** **Reset Value**
0000_H

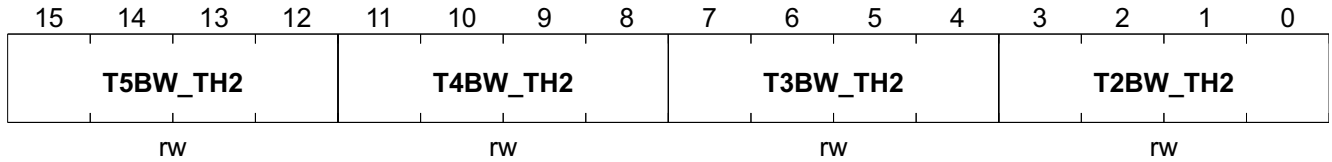

Field	Bits	Type	Description
T5BW_TH2	15:12	rw	Port 5 Transmit Bandwidth Maximum[7:4]. See register 0033 _H , P5TBCE for more detail.
T4BW_TH2	11:8	rw	Port 4 Transmit Bandwidth Maximum[7:4]. See register 0033 _H , P4TBCE for more detail.
T3BW_TH2	7:4	rw	Port 3 Transmit Bandwidth Maximum[7:4]. See register 0033 _H , P3TBCE for more detail.
T2BW_TH2	3:0	rw	Port 2 Transmit Bandwidth Maximum[7:4]. See register 0033 _H , P2TBCE for more detail.

Extended Bandwidth Control Register 4

EBC4 **Offset**
Extended Bandwidth Control Register 4 **38_H** **Reset Value**
0000_H

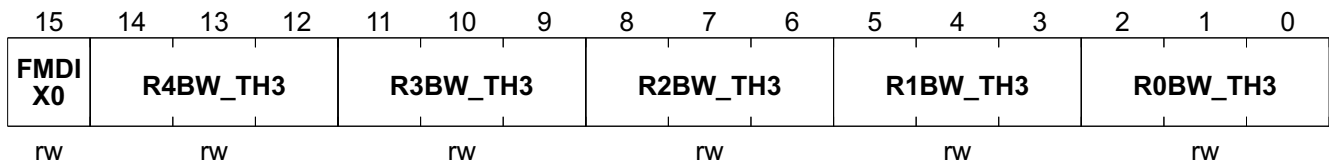

Field	Bits	Type	Description
FMDIX0	15	rw	Port 0 MDIX Control This bit can be used for Port 0 MDI/MDIX selection. It is useful when Port 0 Crossover Auto Detect is disabled and 16 bits management interface (SDC/SDIO) is used. 0 _B Using MDI 1 _B Using MDIX
R4BW_TH3	14:12	rw	Port 4 Receive Bandwidth Maximum[10:8]. See register 0033 _H , P4RBCE for more detail.
R3BW_TH3	11:9	rw	Port 3 Receive Bandwidth Maximum[10:8]. See register 0033 _H , P3RBCE for more detail.
R2BW_TH3	8:6	rw	Port 2 Receive Bandwidth Maximum[10:8]. See register 0033 _H , P2RBCE for more detail.
R1BW_TH3	5:3	rw	Port 1 Receive Bandwidth Maximum[10:8]. See register 0033 _H , P1RBCE for more detail.

16 Bits Mode Registers Description

Field	Bits	Type	Description
R0BW_TH3	2:0	rw	Port 0 Receive Bandwidth Maximum[10:8]. See register 0033 _H , P0RBCE for more detail.

Extended Bandwidth Control Register 5

EBC5 **Offset**
Extended Bandwidth Control Register 5 **39_H** **Reset Value**
0000_H

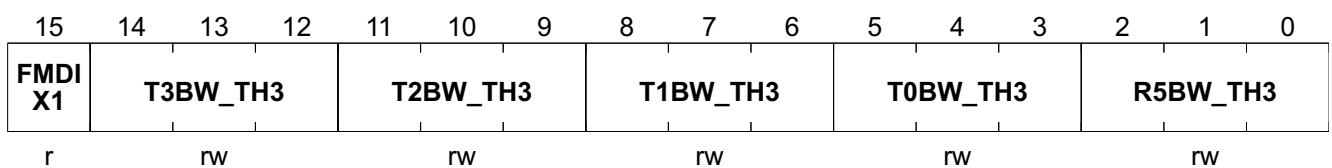

Field	Bits	Type	Description
FMDIX1	15	r	Port 1 MDIX Control This bit can be used for Port 1 MDI/MDIX selection. It is useful when Port 1 Crossover Auto Detect is disabled and 16 bits management interface (SDC/SDIO) is used. 0 _B Using MDI 1 _B Using MDIX
T3BW_TH3	14:12	rw	Port 3 Transmit Bandwidth Maximum[10:8]. See register 0033 _H , P3TBCE for more detail.
T2BW_TH3	11:9	rw	Port 2 Transmit Bandwidth Maximum[10:8]. See register 0033 _H , P2TBCE for more detail.
T1BW_TH3	8:6	rw	Port 1 Transmit Bandwidth Maximum[10:8]. See register 0033 _H , P1TBCE for more detail.
T0BW_TH3	5:3	rw	Port 0 Transmit Bandwidth Maximum[10:8]. See register 0033 _H , P0TBCE for more detail.
R5BW_TH3	2:0	rw	Port 5 Receive Bandwidth Maximum[10:8]. See register 0033 _H , P5RBCE for more detail.

Default VLAN Member and Extended Bandwidth Control Register 6

DVMEBC6 **Offset**
Default VLAN Member and Extended **3A_H** **Reset Value**
Bandwidth Control Register 6 **0FC0_H**

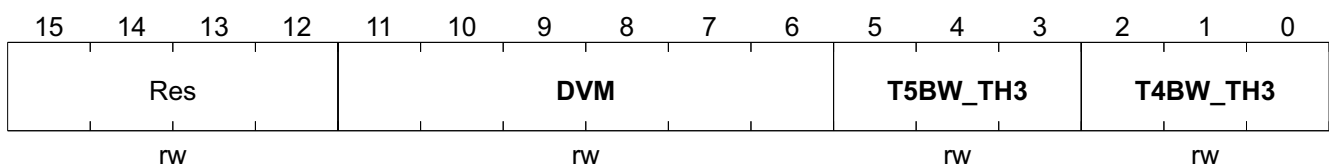

16 Bits Mode Registers Description

Field	Bits	Type	Description
Res	15:12	rw	Reserved
DVM	11:6	rw	Default VLAN Member Always 111111 _B
T5BW_TH3	5:3	rw	Port 5 Transmit Bandwidth Maximum[10:8]. See register 0033 _H , P5TBCE for more detail.
T4BW_TH3	2:0	rw	Port 4 Transmit Bandwidth Maximum[10:8]. See register 0033 _H , P4TBCE for more detail.

New Storm Register 0

NS0 **Offset**
New Storm Register 0 **3B_H** **Reset Value**
0000_H

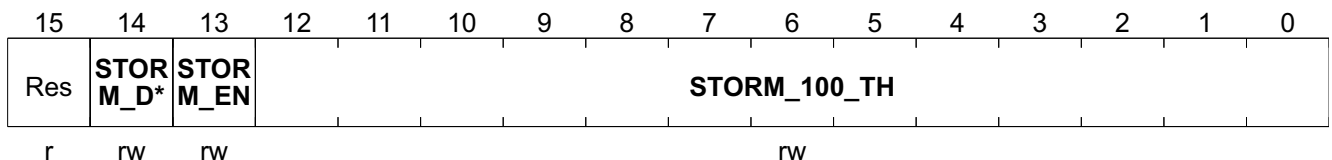

Field	Bits	Type	Description
Res	15	r	Reserved
STORM_DRO P_EN	14	rw	Storm Drop Enable 0 _B Do not drop in the storming period 1 _B Drop in the storming period
STORM_EN	13	rw	Storm Enable 0 _B Disable ADM6996LC/LCX/LHX style broadcast storm protection 1 _B Enable ADM6996LC/LCX/LHX style broadcast storm protection
STORM_100_TH	12:0	rw	100M Threshold See Table 31 for more detail information. It is used when all ports link up in the 100M. The upper bound is reached when the number of the packets received during the 50 ms is over 100M Threshold.

New Storm Register 1

NS1 **Offset**
New Storm Register 1 **3C_H** **Reset Value**
0000_H

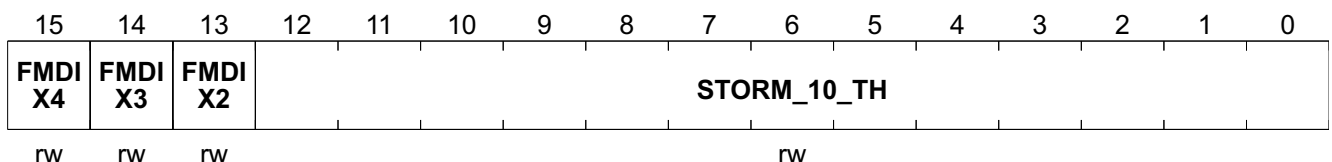

16 Bits Mode Registers Description

Field	Bits	Type	Description
FMDIX4	15	rw	Port 4 MDIX Control This bit can be used for Port 4 MDI/MDIX selection. It is useful when Port 4 Crossover Auto Detect is disabled and 16 bits management interface (SDC/SDIO) is used. 0 _B Using MDI 1 _B Using MDIX
FMDIX3	14	rw	Port 3 MDIX Control This bit can be used for Port 3 MDI/MDIX selection. It is useful when Port 3 Crossover Auto Detect is disabled and 16 bits management interface (SDC/SDIO) is used. 0 _B Using MDI 1 _B Using MDIX
FMDIX2	13	rw	Port 2 MDIX Control This bit can be used for Port 2 MDI/MDIX selection. It is useful when Port 2 Crossover Auto Detect is disabled and 16 bits management interface (SDC/SDIO) is used. 0 _B Using MDI 1 _B Using MDIX
STORM_10_TH	12:0	rw	10M Threshold See Table 31 for more detail information. It is used when one of ports link up in the 10M. The upper bound is reached when the number of the packets received during the 50 ms is over 10M Threshold.

New Reserve Address Control Register 0

NRAC0 **Offset**
New Reserve Address Control Register 0 **3D_H** **Reset Value**
00FD_H

15	14	13	12	11	10	9	8	7	6	5	4	3	2	1	0
NRTB	PG	PRI_S	PRI_B	R3PP	R2PP	GPP	R1PP	R0PP	PPP	SPP	BPP				
rw	rw	rw	rw	rw	rw	rw	rw	rw	rw	rw	rw	rw	rw	rw	rw

Field	Bits	Type	Description
NRTB	15:14	rw	New Reserve TXTAG for BPDU 00 _B System Default Tag 01 _B Unmodified 10 _B Always Tagged 11 _B Always Untagged
PG	13:12	rw	PRI for GXP 00 _B Queue 0 01 _B Queue 1 10 _B Queue 2 11 _B Queue 3

16 Bits Mode Registers Description

Field	Bits	Type	Description
PRI_S	11:10	rw	PRI for SLOW/PAE/RESER_R0/RESER_R1/RESER_R2/RESER_R3 00 _B Queue 0 01 _B Queue 1 10 _B Queue 2 11 _B Queue 3
PRI_B	9:8	rw	PRI for BPDU 00 _B Queue 0 01 _B Queue 1 10 _B Queue 2 11 _B Queue 3
R3PP	7	rw	RESER_R3 Pass Portmap 0 _B RESER_R3 Pass Portmap is 000000 _B 1 _B RESER_R3 Pass Portmap is 111111 _B
R2PP	6	rw	RESER_R2 Pass Portmap 0 _B RESER_R2 Pass Portmap is 000000 _B 1 _B RESER_R2 Pass Portmap is 111111 _B
GPP	5	rw	GXRP Pass Portmap 0 _B GXRP Pass Portmap is 000000 _B 1 _B GXRP Pass Portmap is 111111 _B
R1PP	4	rw	RESER_R1 Pass Portmap 0 _B RESER_R1 Pass Portmap is 000000 _B 1 _B RESER_R1 Pass Portmap is 111111 _B
R0PP	3	rw	RESER_R0 Pass Portmap 0 _B RESER_R0 Pass Portmap is 000000 _B 1 _B RESER_R0 Pass Portmap is 111111 _B
PPP	2	rw	PAE Pass Portmap 0 _B PAE Pass Portmap is 000000 _B 1 _B PAE Pass Portmap is 111111 _B
SPP	1	rw	Slow Pass Portmap 0 _B SLOW Pass Portmap is 000000 _B 1 _B SLOW Pass Portmap is 111111 _B
BPP	0	rw	BPDU Pass Portmap 0 _B BPDU Pass Portmap is 000000 _B 1 _B BPDU Pass Portmap is 111111 _B

New Reserve Address Control Register 1

NRAC1 **Offset**
New Reserve Address Control Register 1 **3E_H** **Reset Value**
0000_H

15	14	13	12	11	10	9	8	7	6	5	4	3	2	1	0
Res		NRMG	NRMS	MRMB	NRSG	NRSS	NRSB	NRCG	NRCS	NRCB	NRTG		NRTS		
rw		rw	rw	rw	rw	rw	rw	rw	rw	rw	rw	rw	rw	rw	

16 Bits Mode Registers Description

Field	Bits	Type	Description
Res	15:13	rw	Reserved
NRMG	12	rw	New Reserve Management for GXP 0 _B Do not identify as management packets 1 _B Identify as management packets
NRMS	11	rw	New Reserve Management for SLOW/PAE/RESER_R0/RESER_R1/RESER_R2/RESER_R3 0 _B Do not identify as management packets 1 _B Identify as management packets
MRMB	10	rw	New Reserve Management for BPDU 0 _B Do not identify as management packets 1 _B Identify as management packets
NRSG	9	rw	New Reserve Span for GXP 0 _B Do not identify as management packets 1 _B Identify as management packets
NRSS	8	rw	New Reserve Span for SLOW/PAE/RESER_R0/RESER_R1/RESER_R2/RESER_R3 0 _B Do not identify as span packets 1 _B Identify as span packets
NRSB	7	rw	New Reserve SPAN for BPDU 0 _B Do not identify as span packets 1 _B Identify as span packets
NRCG	6	rw	New Reserve Cross_VLAN for GXP 0 _B Follow VLAN 1 _B Cross VLAN
NRCS	5	rw	New Reserve Cross_VLAN. for SLOW/PAE/RESER_R0/RESER_R1/RESER_R2/RESER_R3 0 _B Follow VLAN 1 _B Cross VLAN
NRCB	4	rw	New Reserve Cross_VLAN for BPDU 0 _B Follow VLAN 1 _B Cross VLAN
NRTG	3:2	rw	New Reserve TXTAG for GXP 00 _B System Default Tag 01 _B Unmodified 10 _B Always Tagged 11 _B Always Untagged
NRTS	1:0	rw	New Reserve TXTAG for SLOW/PAE/RESER_R0/RESER_R1/RESER_R2/RESER_R3 00 _B System Default Tag 01 _B Unmodified 10 _B Always Tagged 11 _B Always Untagged

5.2 EEPROM Extended Registers

16 Bits Mode Registers Description

VLAN Filter 0 Low

VF0L **Offset**
VLAN Filter 0 Low **40_H** **Reset Value**
003F_H

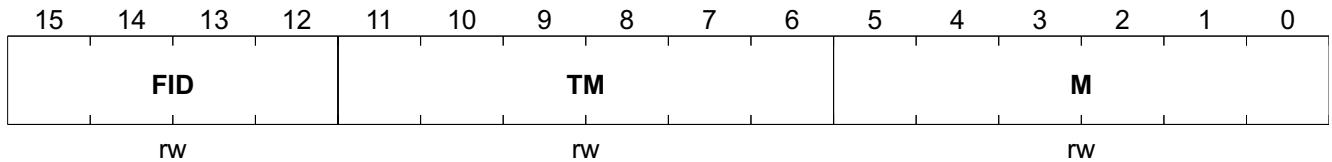

Field	Bits	Type	Description
FID	15:12	rw	FID The forwarding or learning group that the VID is assigned.
TM	11:6	rw	Tagged Member These bits indicate which ports associated with the VID should transmit tagged packets. Tagged Member[x] Description. 0 _B Port x should transmit untagged packets 1 _B Port x should transmit tagged packets
M	5:0	rw	Member These bits indicate which ports are the members of the VLAN. Member[x] Description. 0 _B Port x is not a VLAN member 1 _B Port x is a VLAN member

Similar Registers

Table 40 VFxL Registers

Register Short Name	Register Long Name	Offset Address	Page Number
VF1L	VLAN Filter 1 Low	42 _H	
VF2L	VLAN Filter 2 Low	44 _H	
VF3L	VLAN Filter 3Low	46 _H	
VF4L	VLAN Filter 4 Low	48 _H	
VF5L	VLAN Filter 5 Low	4A _H	
VF6L	VLAN Filter 6 Low	4C _H	
VF7L	VLAN Filter 7 Low	4E _H	
VF8L	VLAN Filter 8 Low	50 _H	
VF9L	VLAN Filter 9 Low	52 _H	
VF10L	VLAN Filter 10 Low	54 _H	
VF11L	VLAN Filter 11 Low	56 _H	
VF12L	VLAN Filter 12 Low	58 _H	
VF13L	VLAN Filter 13 Low	5A _H	
VF14L	VLAN Filter 14 Low	5C _H	
VF15L	VLAN Filter 15 Low	5E _H	

16 Bits Mode Registers Description

VLAN Filter 0 High

VF0H **Offset** **Reset Value**
VLAN Filter 0 High **41_H** **8001_H**

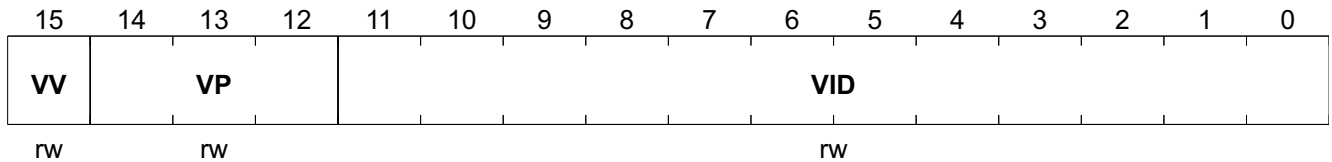

Field	Bits	Type	Description
VV	15	rw	VLAN_Valid 0 _B VLAN filter is not valid 1 _B VLAN Filter is valid
VP	14:12	rw	VLAN PRI It indicates the VLAN priority associated with VID.
VID	11:0	rw	VID It indicates the VLAN ID that is associated with FID, Tagged Member, Member and VLAN PRI.

Similar Registers

All VFxH registers have the same structure and characteristics, see [VF0H](#).
 The offset addresses of the other VFxH registers are listed in [Table 41](#).

Table 41 VFxH Registers

Register Short Name	Register Long Name	Offset Address	Page Number
VF1H	VLAN Filter 1 High	43 _H	
VF2H	VLAN Filter 2 High	45 _H	
VF3H	VLAN Filter 3 High	47 _H	
VF4H	VLAN Filter 4 High	49 _H	
VF5H	VLAN Filter 5 High	4B _H	
VF6H	VLAN Filter 6 High	4D _H	
VF7H	VLAN Filter 7 High	4F _H	
VF8H	VLAN Filter 8 High	51 _H	
VF9H	VLAN Filter 9 High	53 _H	
VF10H	VLAN Filter 10 High	55 _H	
VF11H	VLAN Filter 11 High	57 _H	
VF12H	VLAN Filter 12 High	59 _H	
VF13H	VLAN Filter 13 High	5B _H	
VF14H	VLAN Filter 14 High	5D _H	
VF15H	VLAN Filter 15 High	5F _H	

16 Bits Mode Registers Description

Type Filter 0

TF0 **Offset**
Type Filter 0 **60_H** **Reset Value**
0000_H

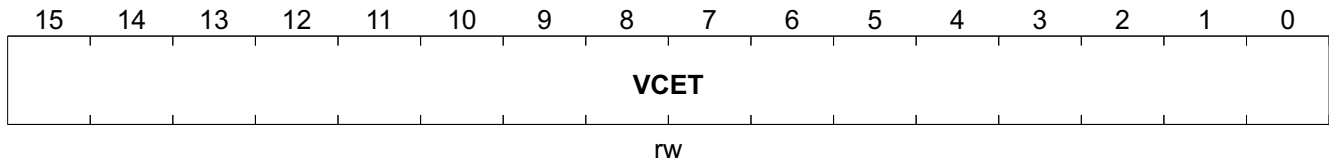

Field	Bits	Type	Description
VCET	15:0	rw	Value Compared with Ether-Type

Similar Registers

All TF_x registers have the same structure and characteristics, see [TF0](#).
 The offset addresses of the other TF_x registers are listed in [Table 42](#).

Table 42 TF_x Registers

Register Short Name	Register Long Name	Offset Address	Page Number
TF1	Type Filter 1	61 _H	
TF2	Type Filter 2	62 _H	
TF3	Type Filter 3	63 _H	
TF4	Type Filter 4	64 _H	
TF5	Type Filter 5	65 _H	
TF6	Type Filter 6	66 _H	
TF7	Type Filter 7	67 _H	

Protocol Filter 1 and 0

PF_1_0 **Offset**
Protocol Filter 1 and 0 **68_H** **Reset Value**
0000_H

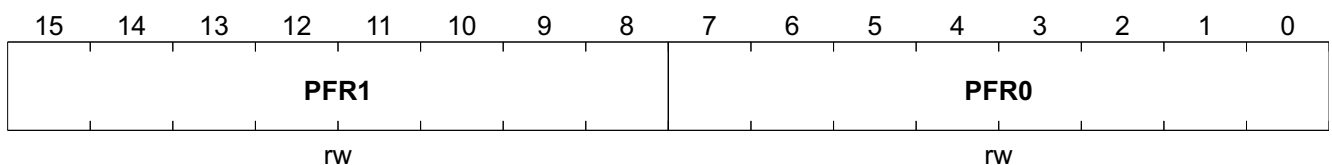

Field	Bits	Type	Description
PFR1	15:8	rw	Value Compared with Protocol in IP Header (Protocol Filter 1, 3, 5, 7)

16 Bits Mode Registers Description

Field	Bits	Type	Description
PFR0	7:0	rw	Value Compared with Protocol in IP Header (Protocol Filter 0, 2, 4, 6)

Similar Registers

All PFx registers have the same structure and characteristics, see [PF_1_0](#).
The offset addresses of the other PFx registers are listed in [Table 43](#).

Table 43 PFx Registers

Register Short Name	Register Long Name	Offset Address	Page Number
PF_3_2	Protocol Filter 3 and 2	68 _H	
PF_5_4	Protocol Filter 5 and 4	69 _H	
PF_7_6	Protocol Filter 7 and 6	6A _H	

TCP/UDP Filter 0

TUF0	Offset	Reset Value
TCP/UDP Filter 0	8C_H	0000_H

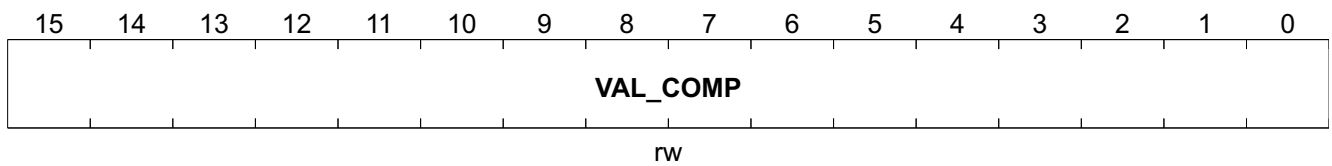

Field	Bits	Type	Description
VAL_COMP	15:0	rw	Value Compared with the Destination Port Number in the TCP/UDP Header

Similar Registers

All TUFx registers have the same structure and characteristics, see [TUF0](#).
The offset addresses of the other TUFx registers are listed in [Table 46](#).

Table 44 TUFx Registers

Register Short Name	Register Long Name	Offset Address	Page Number
TUF1	TCP/UDP Filter 1	8D _H	
TUF2	TCP/UDP Filter 2	8E _H	
TUF3	TCP/UDP Filter 3	8F _H	
TUF4	TCP/UDP Filter 4	90 _H	
TUF5	TCP/UDP Filter 5	91 _H	
TUF6	TCP/UDP Filter 6	92 _H	
TUF7	TCP/UDP Filter 7	93 _H	

16 Bits Mode Registers Description

Type Filter Action

TFA **Offset**
Type Filter Action **94_H** **Reset Value**
0000_H

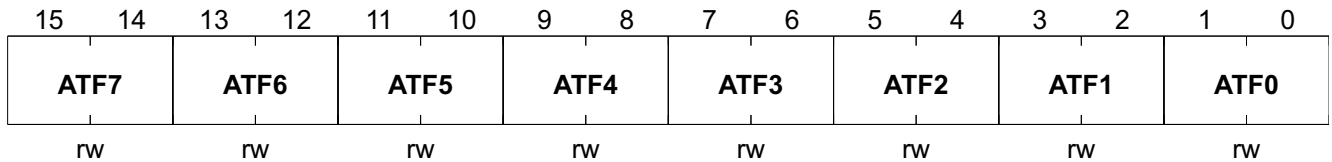

Field	Bits	Type	Description
ATF7	15:14	rw	Action for Type Filter 7 See register 0094 _H , ATF0 for more detail.
ATF6	13:12	rw	Action for Type Filter 6 See register 0094 _H , ATF0 for more detail.
ATF5	11:10	rw	Action for Type Filter 5 See register 0094 _H , ATF0 for more detail.
ATF4	9:8	rw	Action for Type Filter 4 See register 0094 _H , ATF0 for more detail.
ATF3	7:6	rw	Action for Type Filter 3 See register 0094 _H , ATF0 for more detail.
ATF2	5:4	rw	Action for Type Filter 2 See register 0094 _H , ATF0 for more detail.
ATF1	3:2	rw	Action for Type Filter 1 See register 0094 _H , ATF0 for more detail.
ATF0	1:0	rw	Action for Type Filter 0 00 _B Type Portmap is Default Output Ports 01 _B Type Portmap is 000000 _B 10 _B Type Portmap is the CPU port if the incoming port is not the CPU port. But if the incoming port is the CPU port, then Type Portmap contains Default Output Ports , excluding the CPU port 11 _B Type Portmap contains Default Output Ports , excluding the CPU port

Protocol Filter Action

PFA **Offset**
Protocol Filter Action **95_H** **Reset Value**
0000_H

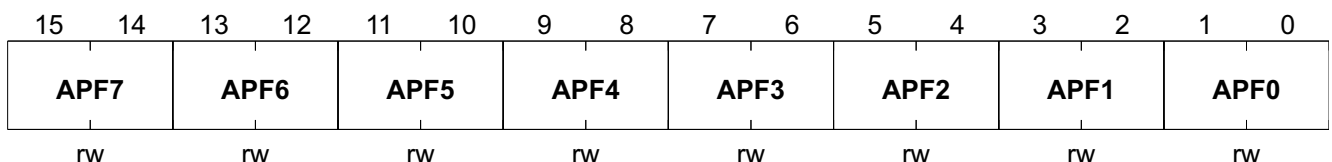

16 Bits Mode Registers Description

Field	Bits	Type	Description
APF7	15:14	rw	Action for Protocol Filter 7 See register 0095 _H , APF0 for more detail.
APF6	13:12	rw	Action for Protocol Filter 6 See register 0095 _H , APF0 for more detail.
APF5	11:10	rw	Action for Protocol Filter 5 See register 0095 _H , APF0 for more detail.
APF4	9:8	rw	Action for Protocol Filter 4 See register 0095 _H , APF0 for more detail.
APF3	7:6	rw	Action for Protocol Filter 3 See register 0095 _H , APF0 for more detail.
APF2	5:4	rw	Action for Protocol Filter 2 See register 0095 _H , APF0 for more detail.
APF1	3:2	rw	Action for Protocol Filter 1 See register 0095 _H , APF0 for more detail.
APF0	1:0	rw	Action for Protocol Filter 0 00 _B Protocol Portmap is Default Output Ports 01 _B Protocol Portmap is 000000 _B 10 _B Protocol Portmap is the CPU port if the incoming port is not the CPU port. But if the incoming port is the CPU port, then Type Portmap contains Default Output Ports , excluding the CPU port 11 _B Protocol Portmap contains Default Output Ports , excluding the CPU port

TCP/UDP Action 0

TUA0 **Offset**
TCP/UDP Action 0 **96_H** **Reset Value**
0000_H

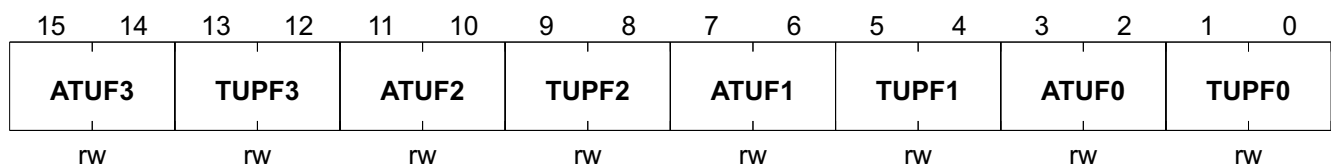

Field	Bits	Type	Description
ATUF3	15:14	rw	Action for TCP/UDP Filter 3. See register 0096 _H , ATUF0 for more detail.
TUPF3	13:12	rw	TCP/UDP PRI for TCP/UDP Filter 3 See register 0096 _H , TUPF0 for more detail.
ATUF2	11:10	rw	Action for TCP/UDP Filter 2 See register 0096 _H , ATUF0 for more detail.
TUPF2	9:8	rw	TCP/UDP PRI for TCP/UDP Filter 2 See register 0096 _H , TUPF0 for more detail.

16 Bits Mode Registers Description

Field	Bits	Type	Description
ATUF1	7:6	rw	Action for TCP/UDP Filter 1 See register 0096 _H , ATUF0 for more detail.
TUPF1	5:4	rw	TCP/UDP PRI for TCP/UDP Filter 1 See register 0096 _H , TUPF0 for more detail.
ATUF0	3:2	rw	Action for TCP/UDP Filter 0 00 _B Protocol Portmap is Default Output Ports 01 _B Protocol Portmap is 000000 _B 10 _B Protocol Portmap is the CPU port if the incoming port is not the CPU port. But if the incoming port is the CPU port, then Type Portmap contains Default Output Ports , excluding the CPU port 11 _B Protocol Portmap contains Default Output Ports , excluding the CPU port
TUPF0	1:0	rw	TCP/UDP PRI for TCP/UDP Filter 0 00 _B Queue 0 01 _B Queue 1 10 _B Queue 2 11 _B Queue 3

TCP/UDP Action 1

TUA1 **Offset** **Reset Value**
TCP/UDP Action 1 **97_H** **0000_H**

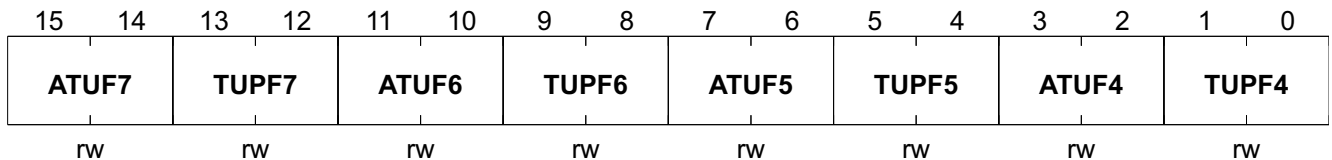

Field	Bits	Type	Description
ATUF7	15:14	rw	Action for TCP/UDP Filter 7 See register 0096 _H , ATUF0 for more detail.
TUPF7	13:12	rw	TCP/UDP PRI for TCP/UDP Filter 7 See register 0096 _H , TUPF0 for more detail.
ATUF6	11:10	rw	Action for TCP/UDP Filter 6 See register 0096 _H , ATUF0 for more detail.
TUPF6	9:8	rw	TCP/UDP PRI for TCP/UDP Filter 6 See register 0096 _H , TUPF0 for more detail.
ATUF5	7:6	rw	Action for TCP/UDP Filter 5 See register 0096 _H , ATUF0 for more detail.
TUPF5	5:4	rw	TCP/UDP PRI for TCP/UDP Filter 5 See register 0096 _H , TUPF0 for more detail.
ATUF4	3:2	rw	Action for TCP/UDP Filter 4 See register 0096 _H , ATUF0 for more detail.

16 Bits Mode Registers Description

Field	Bits	Type	Description
TUPF4	1:0	rw	TCP/UDP PRI for TCP/UDP Filter 4 See register 0096 _H , TUPF0 for more detail.

TCP/UDP Action 2

TUA2	Offset	Reset Value
TCP/UDP Action 2	98_H	0000_H

15	14	13	12	11	10	9	8	7	6	5	4	3	2	1	0
Res		COMP		P5I	P4I	P3I	P2I	P1I	P0I	P5T	P4T	P3T	P2T	P1T	P0T
r		rw		rw	rw	rw	rw	rw	rw	rw	rw	rw	rw	rw	rw

Field	Bits	Type	Description
Res	15:14	r	Reserved
COMP	13:12	rw	Compare TCP/UDP Source Port or Destination Port 00 _B Do not Compare 01 _B Compare Destination Port 10 _B Compare Source Port 11 _B Compare Destination Port or Source Port
P5I	11	rw	Port 5 IP over TCP/UDP 0 _B Use TCP/UDP field when packets contain both TCP/UDP and IP 1 _B Use IP field when packets contain both TCP/UDP and IP
P4I	10	rw	Port 4 IP over TCP/UDP 0 _B Use TCP/UDP field when packets contain both TCP/UDP and IP 1 _B Use IP field when packets contain both TCP/UDP and IP
P3I	9	rw	Port 3 IP over TCP/UDP 0 _B Use TCP/UDP field when packets contain both TCP/UDP and IP 1 _B Use IP field when packets contain both TCP/UDP and IP
P2I	8	rw	Port 2 IP over TCP/UDP 0 _B Use TCP/UDP field when packets contain both TCP/UDP and IP 1 _B Use IP field when packets contain both TCP/UDP and IP
P1I	7	rw	Port 1 IP over TCP/UDP 0 _B Use TCP/UDP field when packets contain both TCP/UDP and IP 1 _B Use IP field when packets contain both TCP/UDP and IP
P0I	6	rw	Port 0 IP over TCP/UDP 0 _B Use TCP/UDP field when packets contain both TCP/UDP and IP 1 _B Use IP field when packets contain both TCP/UDP and IP
P5T	5	rw	Port 5 TCP/UDP PRIEN 0 _B Do not use TCP/UDP priority 1 _B Use TCP/UDP priority
P4T	4	rw	Port 4 TCP/UDP PRIEN 0 _B Do not use TCP/UDP priority 1 _B Use TCP/UDP priority

16 Bits Mode Registers Description

Field	Bits	Type	Description
P3T	3	rw	Port 3 TCP/UDP PRIEN 0 _B Do not use TCP/UDP priority 1 _B Use TCP/UDP priority
P2T	2	rw	Port 2 TCP/UDP PRIEN 0 _B Do not use TCP/UDP priority 1 _B Use TCP/UDP priority
P1T	1	rw	Port 1 TCP/UDP PRIEN 0 _B Do not use TCP/UDP priority 1 _B Use TCP/UDP priority
P0T	0	rw	Port 0 TCP/UDP PRIEN 0 _B Do not use TCP/UDP priority 1 _B Use TCP/UDP priority

Interrupt Enable Register

IE **Offset**
Interrupt Enable Register **9A_H** **Reset Value**
0000_H

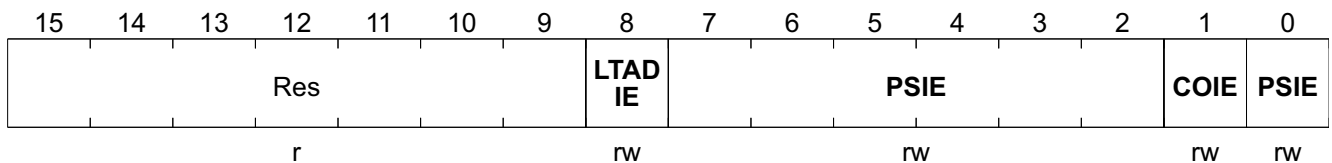

Field	Bits	Type	Description
Res	15:9	r	Reserved
LTADIE	8	rw	Leaning Table Access Done Interrupt Enable 0 _B Interrupt disable 1 _B Interrupt enable
PSIE	7:2	rw	Port Security Interrupt Enable It's a per port setting 0 _B Interrupt disable 1 _B Interrupt enable
COIE	1	rw	Counter Overflow Interrupt Enable 0 _B Interrupt disable 1 _B Interrupt enable
PSIE	0	rw	Port Status Interrupt Enable 0 _B Interrupt disable 1 _B Interrupt enable

Interrupt Status Register

IS **Offset**
Interrupt Status Register **9B_H** **Reset Value**
0000_H

16 Bits Mode Registers Description

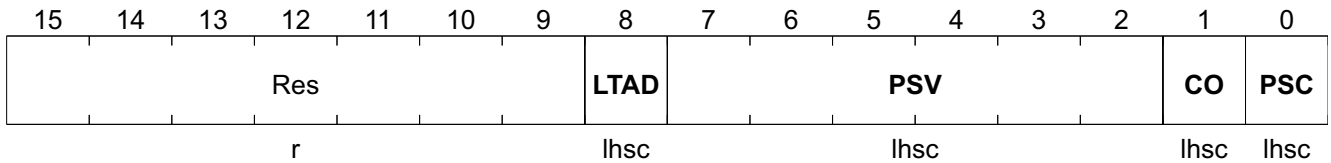

Field	Bits	Type	Description
Res	15:9	r	Reserved
LTAD	8	lhsc	Leaning Table Access Done 0 _B Access does not end 1 _B Access end
PSV	7:2	lhsc	Port Security Violation It's a per port setting 0 _B Security did not violate 1 _B Security violated
CO	1	lhsc	Counter Overflow 0 _B Overflow did not happen 1 _B Overflow happened for any of the counters
PSC	0	lhsc	Port Status Change 0 _B No status (link, speed, duplex, flow control) changed for any port 1 _B Status changed for any of 6 ports

5.3 Counter and Switch Status Registers

Chip Identifier 0

C10	Offset	Reset Value
Chip Identifier 0	A0 _H	1022 _H

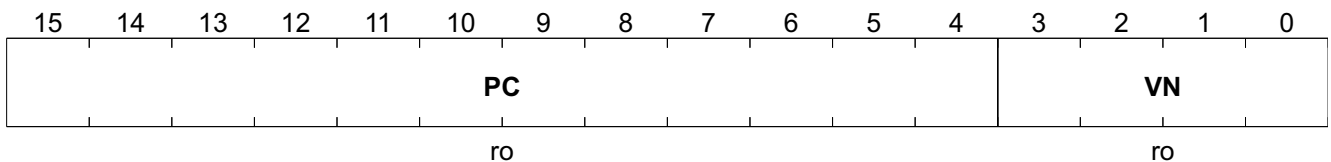

Field	Bits	Type	Description
PC	15:4	ro	Product Code[11:0]
VN	3:0	ro	Version Number

Chip Identifier 1

C11	Offset	Reset Value
Chip Identifier 1	A1 _H	0007 _H

16 Bits Mode Registers Description

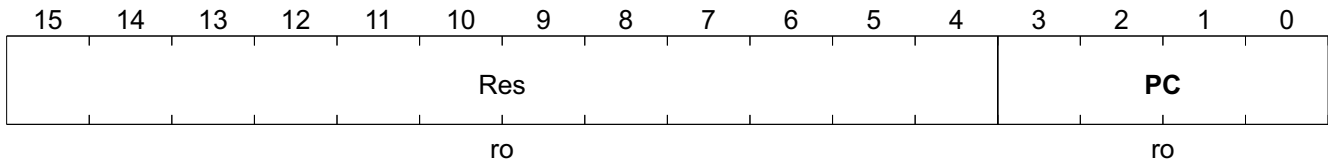

Field	Bits	Type	Description
Res	15:4	ro	Reserved
PC	3:0	ro	Product Code[15:12]

Port Status 0

PS0	Offset	Reset Value
Port Status 0	A2_H	0000_H

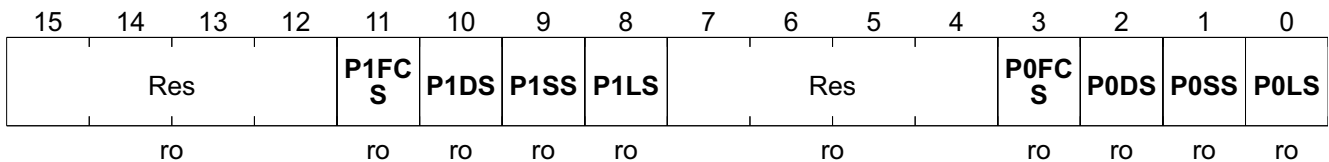

Field	Bits	Type	Description
Res	15:12	ro	Reserved
P1FCS	11	ro	Port 1 Flow Control Status 0 _B Port 1 disables the Full Flow Control/Half Back Pressure Function 1 _B Port 1 enabled the Full Flow Control/Half Back Pressure Function
P1DS	10	ro	Port 1 Duplex Status 0 _B Port 1 operates in the Half Duplex 1 _B Port 1 operates in the Full Duplex
P1SS	9	ro	Port 1 Speed Status 0 _B Port 1 operates in the 10M 1 _B Port 1 operates in the 100M
P1LS	8	ro	Port 1 Link Status 0 _B Port 1 links down 1 _B Port 1 links up
Res	7:4	ro	Reserved
P0FCS	3	ro	Port 0 Flow Control Status 0 _B Port 0 disables the Full Flow Control/Half Back Pressure Function 1 _B Port 0 enabled the Full Flow Control/Half Back Pressure Function
P0DS	2	ro	Port 0 Duplex Status 0 _B Port 0 operates in the Half Duplex 1 _B Port 0 operates in the Full Duplex
P0SS	1	ro	Port 0 Speed Status 0 _B Port 0 operates in the 10M 1 _B Port 0 operates in the 100M

16 Bits Mode Registers Description

Field	Bits	Type	Description
P0LS	0	ro	Port 0 Link Status 0 _B Port 0 links down 1 _B Port 0 links up

Port Status 1

PS1 **Offset**
Port Status 1 **A3_H** **Reset Value**
0000_H

15	14	13	12	11	10	9	8	7	6	5	4	3	2	1	0
P4FC S	P4DS	P4SS	P4LS	P3FC S	P3DS	P3SS	P3LS	Res			P2FC S	P2DS	P2SS	P2LS	
ro	ro	ro	ro	ro	ro	ro	ro	ro			ro	ro	ro	ro	

Field	Bits	Type	Description
P4FCS	15	ro	Port 4 Flow Control Status 0 _B Port 4 disables the Full Flow Control/Half Back Pressure Function 1 _B Port 4 enabled the Full Flow Control/Half Back Pressure Function
P4DS	14	ro	Port 4 Duplex Status 0 _B Port 4 operates in the Half Duplex 1 _B Port 4 operates in the Full Duplex
P4SS	13	ro	Port 4 Speed Status 0 _B Port 4 operates in the 10M 1 _B Port 4 operates in the 100M
P4LS	12	ro	Port 4 Link Status 0 _B Port 4 links down 1 _B Port 4 links up
P3FCS	11	ro	Port 3 Flow Control Status 0 _B Port 3 disables the Full Flow Control/Half Back Pressure Function 1 _B Port 3 enabled the Full Flow Control/Half Back Pressure Function
P3DS	10	ro	Port 3 Duplex Status 0 _B Port 3 operates in the Half Duplex 1 _B Port 3 operates in the Full Duplex
P3SS	9	ro	Port 3 Speed Status 0 _B Port 3 operates in the 10M 1 _B Port 3 operates in the 100M
P3LS	8	ro	Port 3 Link Status 0 _B Port 3 links down 1 _B Port 3 links up.
Res	7:4	ro	Reserved
P2FCS	3	ro	Port 2 Flow Control Status 0 _B Port 2 disables the Full Flow Control/Half Back Pressure Function 1 _B Port 2 enabled the Full Flow Control/Half Back Pressure Function

16 Bits Mode Registers Description

Field	Bits	Type	Description
P2DS	2	ro	Port 2 Duplex Status 0 _B Port 2 operates in the Half Duplex 1 _B Port 2 operates in the Full Duplex
P2SS	1	ro	Port 2 Speed Status 0 _B Port 2 operates in the 10M 1 _B Port 2 operates in the 100M
P2LS	0	ro	Port 2 Link Status 0 _B Port 2 links down 1 _B Port 2 links up

Port Status 2

PS2 **Offset**
Port Status 2 **A4_H** **Reset Value**
0000_H

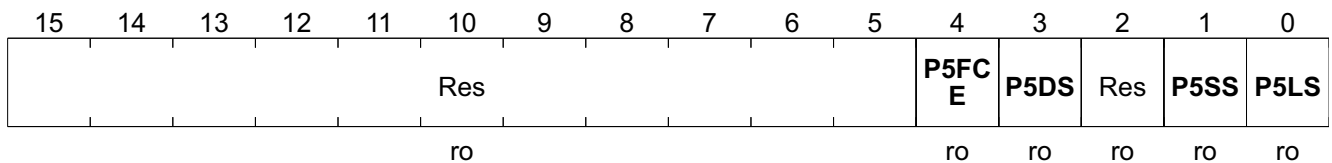

Field	Bits	Type	Description
Res	15:5	ro	Reserved
P5FCE	4	ro	Port 5 Flow Control Enable 0 _B Port 5 disables the Full Flow Control/Half Back Pressure Function 1 _B Port 5 enabled the Full Flow Control/Half Back Pressure Function
P5DS	3	ro	Port 5 Duplex Status 0 _B Port 5 operates in the Half Duplex 1 _B Port 5 operates in the Full Duplex
Res	2	ro	Reserved
P5SS	1	ro	Port 5 Speed Status 0 _B Port 5 operates in the 10M 1 _B Port 5 operates in the 100M
P5LS	0	ro	Port 5 Link Status 0 _B Port 5 links down 1 _B Port 5 links up

Counter Low 0

CL0 **Offset**
Port 0 Receive Packet Counter Low **A8_H** **Reset Value**
0000_H

16 Bits Mode Registers Description

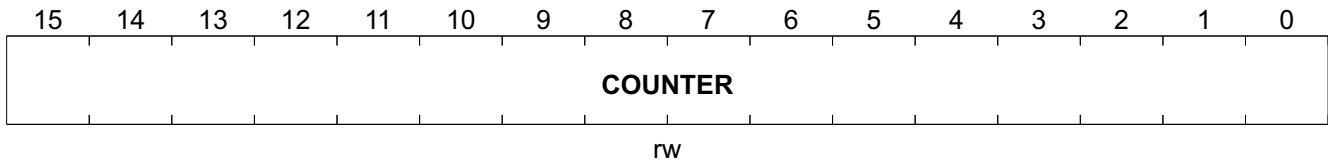

Field	Bits	Type	Description
COUNTER	15:0	rw	Counter[15:0]

Similar Registers

All CLx registers have the same structure and characteristics, see [CL0](#).
The offset addresses of the other CLx registers are listed in [Table 45](#).

Table 45 CLx Registers

Register Short Name	Register Long Name	Offset Address	Page Number
CL1	Port 1 Receive Packet Counter Low	AC _H	
CL2	Port 2 Receive Packet Counter Low	B0 _H	
CL3	Port 3 Receive Packet Counter Low	B4 _H	
CL4	Port 4 Receive Packet Counter Low	B6 _H	
CL5	Port 5 Receive Packet Counter Low	B8 _H	
CL6	Port 0 Receive Packet Byte Count Low	BA _H	
CL7	Port 1 Receive Packet Byte Count Low	BE _H	
CL8	Port 2 Receive Packet Byte Count Low	C2 _H	
CL9	Port 3 Receive Packet Byte Count Low	C6 _H	
CL10	Port 4 Receive Packet Byte Count Low	C8 _H	
CL11	Port 5 Receive Packet Byte Count Low	CA _H	
CL12	Port 0 Transmit Packet Count Low	CC _H	
CL13	Port 1 Transmit Packet Count Low	D0 _H	
CL14	Port 2 Transmit Packet Count Low	D4 _H	
CL15	Port 3 Transmit Packet Count Low	D8 _H	
CL16	Port 4 Transmit Packet Count Low	DA _H	
CL17	Port 5 Transmit Packet Count Low	DC _H	
CL18	Port 0 Transmit Packet Byte Count Low	DE _H	
CL19	Port 1 Transmit Packet Byte Count Low	E2 _H	
CL20	Port 2 Transmit Packet Byte Count Low	E6 _H	
CL21	Port 3 Transmit Packet Byte Count Low	EA _H	
CL22	Port 4 Transmit Packet Byte Count Low	EC _H	
CL23	Port 5 Transmit Packet Byte Count Low	EE _H	
CL24	Port 0 Collision Count Low	F0 _H	
CL25	Port 1 Collision Count Low	F4 _H	
CL26	Port 2 Collision Count Low	F8 _H	
CL27	Port 3 Collision Count Low	FC _H	
CL28	Port 4 Collision Count Low	FE _H	
CL29	Port 5 Collision Count Low	100 _H	

16 Bits Mode Registers Description

Table 45 CLx Registers (cont'd)

Register Short Name	Register Long Name	Offset Address	Page Number
CL30	Port 0 Error Count Low	102 _H	
CL31	Port 1 Error Count Low	106 _H	
CL32	Port 2 Error Count Low	10A _H	
CL33	Port 3 Error Count Low	10E _H	
CL34	Port 4 Error Count Low	110 _H	
CL35	Port 5 Error Count Low	112 _H	

Counter High 0

CH0	Offset	Reset Value
Port 0 Receive Packet Counter High	A9_H	0000_H

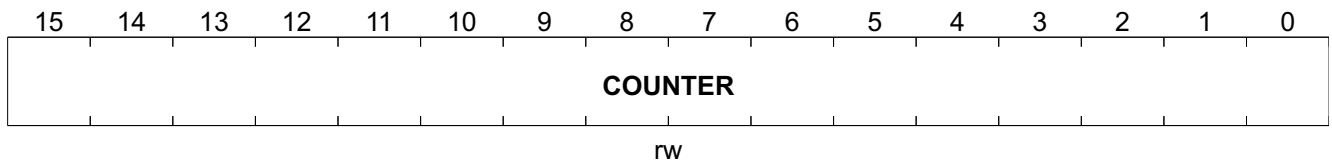

Field	Bits	Type	Description
COUNTER	15:0	rw	Counter[31:16]

Similar Registers

All CHx registers have the same structure and characteristics, see [CH0](#).
The offset addresses of the other CLH registers are listed in [Table 46](#).

Table 46 CHx Registers

Register Short Name	Register Long Name	Offset Address	Page Number
CH1	Port 1 Receive Packet Counter High	AD _H	
CH2	Port 2 Receive Packet Counter High	B1 _H	
CH3	Port 3 Receive Packet Counter High	B5 _H	
CH4	Port 4 Receive Packet Counter High	B7 _H	
CH5	Port 5 Receive Packet Counter High	B9 _H	
CH6	Port 0 Receive Packet Byte Count High	BB _H	
CH7	Port 1 Receive Packet Byte Count High	BF _H	
CH8	Port 2 Receive Packet Byte Count High	C3 _H	
CH9	Port 3 Receive Packet Byte Count High	C7 _H	
CH10	Port 4 Receive Packet Byte Count High	C9 _H	
CH11	Port 5 Receive Packet Byte Count High	CB _H	
CH12	Port 0 Transmit Packet Count High	CD _H	
CH13	Port 1 Transmit Packet Count High	D1 _H	
CH14	Port 2 Transmit Packet Count High	D5 _H	

16 Bits Mode Registers Description

Table 46 CHx Registers (cont'd)

Register Short Name	Register Long Name	Offset Address	Page Number
CH15	Port 3 Transmit Packet Count High	D9 _H	
CH16	Port 4 Transmit Packet Count High	DB _H	
CH17	Port 5 Transmit Packet Count High	DD _H	
CH18	Port 0 Transmit Packet Byte Count High	DF _H	
CH19	Port 1 Transmit Packet Byte Count High	E3 _H	
CH20	Port 2 Transmit Packet Byte Count High	E7 _H	
CH21	Port 3 Transmit Packet Byte Count High	EB _H	
CH22	Port 4 Transmit Packet Byte Count High	ED _H	
CH23	Port 5 Transmit Packet Byte Count High	EF _H	
CH24	Port 0 Collision Count High	F1 _H	
CH25	Port 1 Collision Count High	F5 _H	
CH26	Port 2 Collision Count High	F9 _H	
CH27	Port 3 Collision Count High	FD _H	
CH28	Port 4 Collision Count High	FF _H	
CH29	Port 5 Collision Count High	101 _H	
CH30	Port 0 Error Count High	103 _H	
CH31	Port 1 Error Count High	107 _H	
CH32	Port 2 Error Count High	10B _H	
CH33	Port 3 Error Count High	10F _H	
CH34	Port 4 Error Count High	111 _H	
CH35	Port 5 Error Count High	113 _H	

Over-Flow Flag 0

OFF0	Offset	Reset Value
Over-Flow Flag 0	114 _H	0000 _H

15	14	13	12	11	10	9	8	7	6	5	4	3	2	1	0
P3_B C	Res	P2_B C	Res	P1_B C	Res	P0_B C	P5_C	P4_C	P3_C	Res	P2_C	Res	P1_C	Res	P0_C
lhsc	ro	lhsc	ro	lhsc	ro	lhsc	lhsc	lhsc	lhsc	ro	lhsc	ro	lhsc	ro	lhsc

Field	Bits	Type	Description
P3_BC	15	lhsc	Overflow of Port 3 Receive Packet Byte Count 0 _B No overflow 1 _B Overflow
Res	14	ro	Reserved
P2_BC	13	lhsc	Overflow of Port 2 Receive Packet Byte Count 0 _B No overflow 1 _B Overflow

16 Bits Mode Registers Description

Field	Bits	Type	Description
Res	12	ro	Reserved
P1_BC	11	lhsc	Overflow of Port 1 Receive Packet Byte Count 0 _B No overflow 1 _B Overflow
Res	10	ro	Reserved
P0_BC	9	lhsc	Overflow of Port 0 Receive Packet Byte Count 0 _B No overflow 1 _B Overflow
P5_C	8	lhsc	Overflow of Port 5 Receive Packet Count 0 _B No overflow 1 _B Overflow
P4_C	7	lhsc	Overflow of Port 4 Receive Packet Count 0 _B No overflow 1 _B Overflow
P3_C	6	lhsc	Overflow of Port 3 Receive Packet Count 0 _B No overflow 1 _B Overflow
Res	5	ro	Reserved
P2_C	4	lhsc	Overflow of Port 2 Receive Packet Count 0 _B No overflow 1 _B Overflow
Res	3	ro	Reserved
P1_C	2	lhsc	Overflow of Port 1 Receive Packet Count 0 _B No overflow 1 _B Overflow
Res	1	ro	Reserved
P0_C	0	lhsc	Overflow of Port 0 Receive Packet Count 0 _B No overflow 1 _B Overflow

Over-Flow Flag 1

OFF1	Offset	Reset Value
Over-Flow Flag 1	115_H	0000_H

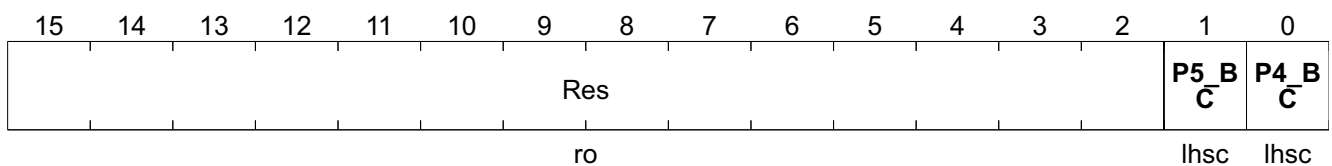

Field	Bits	Type	Description
Res	15:2	ro	Reserved

16 Bits Mode Registers Description

Field	Bits	Type	Description
P5_BC	1	lhsc	Overflow of Port 5 Receive Packet Byte Count 0 _B No overflow 1 _B Overflow
P4_BC	0	lhsc	Overflow of Port 4 Receive Packet Byte Count 0 _B No overflow 1 _B Overflow

Over-Flow Flag 2

OFF2 **Offset**
Over-Flow Flag 2 **116_H** **Reset Value**
0000_H

15	14	13	12	11	10	9	8	7	6	5	4	3	2	1	0
P3_B C	Res	P2_B C	Res	P1_B C	Res	P0_B C	P5_C	P4_C	P3_C	Res	P2_C	Res	P1_C	Res	P0_C
lhsc	ro	lhsc	ro	lhsc	ro	lhsc	lhsc	lhsc	lhsc	ro	lhsc	ro	lhsc	ro	lhsc

Field	Bits	Type	Description
P3_BC	15	lhsc	Overflow of Port 3 Transmit Packet Byte Count 0 _B No overflow 1 _B Overflow
Res	14	ro	Reserved
P2_BC	13	lhsc	Overflow of Port 2 Transmit Packet Byte Count 0 _B No overflow 1 _B Overflow
Res	12	ro	Reserved
P1_BC	11	lhsc	Overflow of Port 1 Transmit Packet Byte Count 0 _B No overflow 1 _B Overflow
Res	10	ro	Reserved
P0_BC	9	lhsc	Overflow of Port 0 Transmit Packet Byte Count 0 _B No overflow 1 _B Overflow
P5_C	8	lhsc	Overflow of Port 5 Transmit Packet Count 0 _B No overflow 1 _B Overflow
P4_C	7	lhsc	Overflow of Port 4 Transmit Packet Count 0 _B No overflow 1 _B Overflow
P3_C	6	lhsc	Overflow of Port 3 Transmit Packet Count 0 _B No overflow 1 _B Overflow
Res	5	ro	Reserved

16 Bits Mode Registers Description

Field	Bits	Type	Description
P2_C	4	lhsc	Overflow of Port 2 Transmit Packet Count 0 _B No overflow 1 _B Overflow
Res	3	ro	Reserved
P1_C	2	lhsc	Overflow of Port 1 Transmit Packet Count 0 _B No overflow 1 _B Overflow
Res	1	ro	Reserved
P0_C	0	lhsc	Overflow of Port 0 Transmit Packet Count 0 _B No overflow 1 _B Overflow

Over-Flow Flag 3

OFF3 **Offset** **Reset Value**
Over-Flow Flag 3 **117_H** **0000_H**

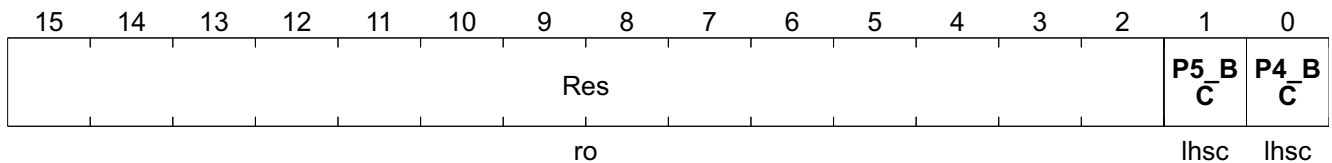

Field	Bits	Type	Description
Res	15:2	ro	Reserved
P5_BC	1	lhsc	Overflow of Port 5 Transmit Packet Byte Count 0 _B No overflow 1 _B Overflow
P4_BC	0	lhsc	Overflow of Port 4 Transmit Packet Byte Count 0 _B No overflow 1 _B Overflow

Over-Flow Flag 4

OFF4 **Offset** **Reset Value**
Over-Flow Flag 4 **118_H** **0000_H**

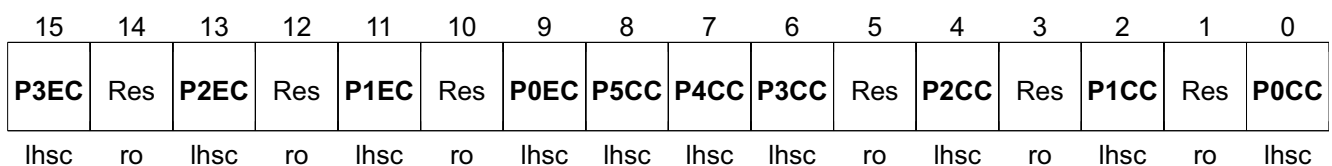

16 Bits Mode Registers Description

Field	Bits	Type	Description
P3EC	15	lhsc	Overflow of Port 3 Error Count 0 _B No overflow 1 _B Overflow
Res	14	ro	Reserved
P2EC	13	lhsc	Overflow of Port 2 Error Count 0 _B No overflow 1 _B Overflow
Res	12	ro	Reserved
P1EC	11	lhsc	Overflow of Port 1 Error Count 0 _B No overflow 1 _B Overflow
Res	10	ro	Reserved
P0EC	9	lhsc	Overflow of Port 0 Error Count 0 _B No overflow 1 _B Overflow
P5CC	8	lhsc	Overflow of Port 5 Collision Count 0 _B No overflow 1 _B Overflow
P4CC	7	lhsc	Overflow of Port 4 Collision Count 0 _B No overflow 1 _B Overflow
P3CC	6	lhsc	Overflow of Port 3 Collision Count 0 _B No overflow 1 _B Overflow
Res	5	ro	Reserved
P2CC	4	lhsc	Overflow of Port 2 Collision Count 0 _B No overflow 1 _B Overflow
Res	3	ro	Reserved
P1CC	2	lhsc	Overflow of Port 1 Collision Count 0 _B No overflow 1 _B Overflow
Res	1	ro	Reserved
P0CC	0	lhsc	Overflow of Port 0 Collision Count 0 _B No overflow 1 _B Overflow

Over-Flow Flag 5

OFF5	Offset	Reset Value
Over-Flow Flag 5	119_H	0000_H

16 Bits Mode Registers Description

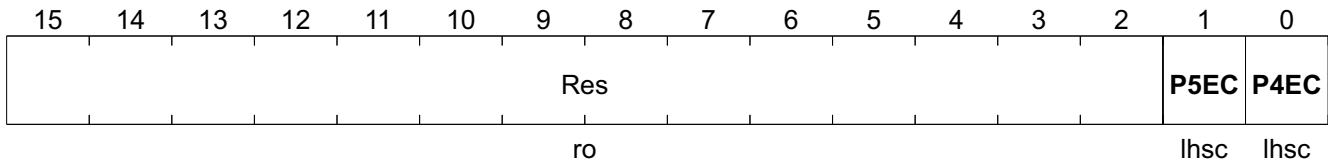

Field	Bits	Type	Description
Res	15:2	ro	Reserved
P5EC	1	lhsc	Overflow of Port 5 Error Count 0 _B No overflow 1 _B Overflow
P4EC	0	lhsc	Overflow of Port 4 Error Count 0 _B No overflow 1 _B Overflow

Hardware Setting Low Register

HSL	Offset	Reset Value
Hardware Setting Low Register	130 _H	0000 _H

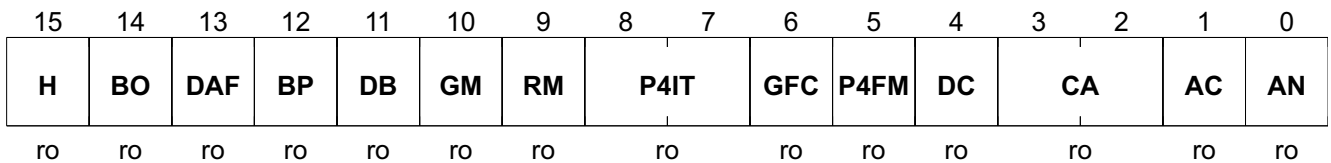

Field	Bits	Type	Description
H	15	ro	Resreved
BO	14	ro	Bond
DAF	13	ro	Disable ADM6996LC/LCX/LHX Function
BP	12	ro	BPEN
DB	11	ro	16/32 Bit Data Bus
GM	10	ro	GPSI Mode
RM	9	ro	RMII Mode
P4IT	8:7	ro	Port 4 Interface Type
GFC	6	ro	Global Flow Control
P4FM	5	ro	Port 4 Fiber Mode
DC	4	ro	Dual Color
CA	3:2	ro	Chip Address
AC	1	ro	Auto-Crossover
AN	0	ro	Auto-Negotiation

Hardware Setting High Register

16 Bits Mode Registers Description

HSH **Offset**
Hardware Setting High Register **131_H** **Reset Value**
0000_H

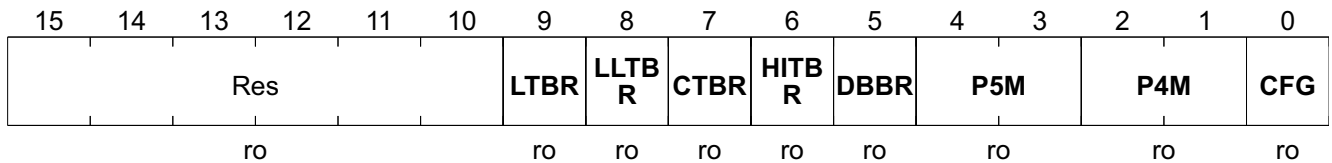

Field	Bits	Type	Description
Res	15:10	ro	Reserved
LTBR	9	ro	Learning Table Bist Result 0 _B Work 1 _B Do not Work
LLTBR	8	ro	Linklist Table Bist Result (Linklist Table does not do bist test in normal mode) 0 _B Work 1 _B Do not Work
CTBR	7	ro	Control Table Bist Result 0 _B Work 1 _B Do not Work
HITBR	6	ro	Hardware IGMP Table Bist Result 0 _B Work 1 _B Do not Work
DBBR	5	ro	Data Buffer Bist Result 0 _B Work 1 _B Do not Work
P5M	4:3	ro	P5 Mode 00 _B GPSI 01 _B RMII 10 _B MII
P4M	2:1	ro	P4 Mode 00 _B Port 4 uses inner PHY 01 _B Port 4 uses MII 11 _B Port 4 isolated PHY
CFG	0	ro	CFG

Assign Option Register

AO **Offset**
Assign Option Register **135_H** **Reset Value**
0000_H

16 Bits Mode Registers Description

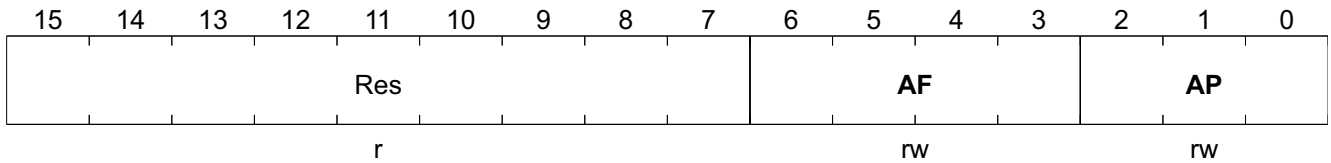

Field	Bits	Type	Description
Res	15:7	r	Reserved
AF	6:3	rw	Assign Fid It is used for assign lock FID.
AP	2:0	rw	Assign Port It is used for the port that the user wants to assign or for the monitor port.

Security Violation Port

SVP **Offset**
Security Violation Port **138_H** **Reset Value**
0000_H

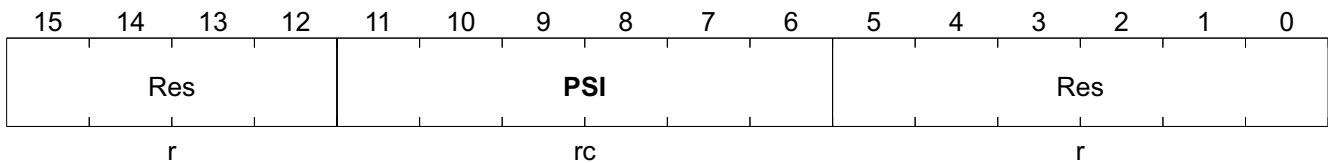

Field	Bits	Type	Description
Res	15:12	r	Reserved
PSI	11:6	rc	Port Source Intrusion 0 _B Source Intrusion did not happen 1 _B Source Intrusion happened
Res	5:0	r	Reserved

Security Status 0

SS0 **Offset**
Security Status 0 **139_H** **Reset Value**
0000_H

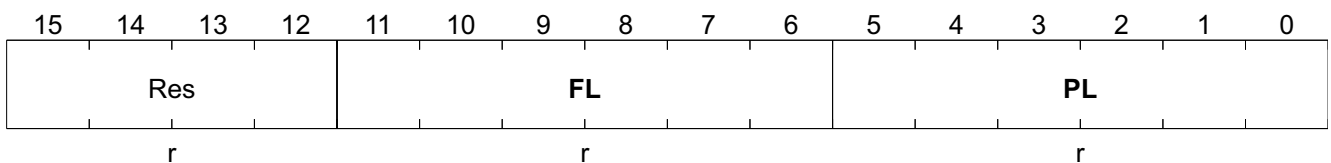

16 Bits Mode Registers Description

Field	Bits	Type	Description
Res	15:12	r	Reserved
FL	11:6	r	First Lock 0 _B Port did not lock the address 1 _B Port locked the address
PL	5:0	r	Port Locked 0 _B Port did not close 1 _B Port closed because of source violation

Security Status 1

SS1 **Offset**
Security Status 1 **13A_H** **Reset Value**
0000_H

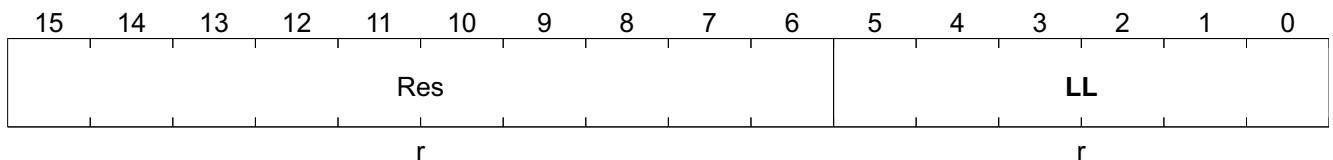

Field	Bits	Type	Description
Res	15:6	r	Reserved
LL	5:0	r	Link Lock 0 _B Link Lock did not happen 1 _B Link Lock happened

First Lock Address Search

FLAS **Offset**
First Lock Address Search **13B_H** **Reset Value**
0000_H

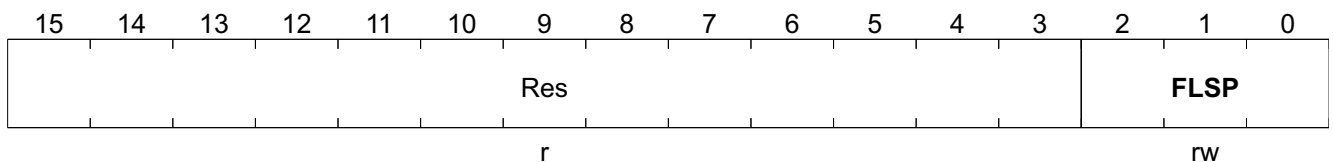

Field	Bits	Type	Description
Res	15:3	r	Reserved

16 Bits Mode Registers Description

Field	Bits	Type	Description
FLSP	2:0	rw	First Lock Search Port Users could write this register to get the lock address and the lock FID (returned in the 13C _H , 13D _H , 13E _H , 13F _H) associated with the port. 000 _B Search the address and FID locked on the port 0 001 _B Search the address and FID locked on the port 1 010 _B Search the address and FID locked on the port 1 011 _B Search the address and FID locked on the port 1 100 _B Search the address and FID locked on the port 1 101 _B Search the address and FID locked on the port 1

First Lock Address [15:0]

FLA1	Offset	Reset Value
First Lock Address [15:0]	13C _H	0000 _H

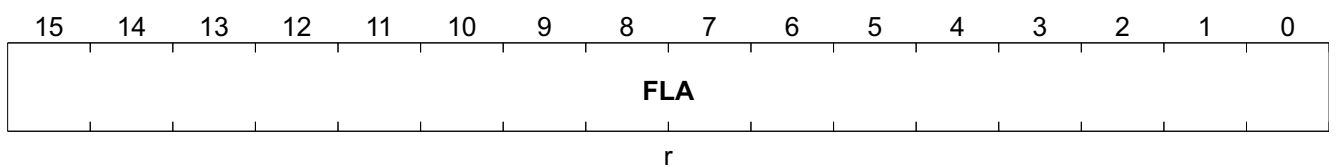

Field	Bits	Type	Description
FLA	15:0	r	First Lock Address [15:0]

First Lock Address [31:16]

FLA2	Offset	Reset Value
First Lock Address [31:16]	13D _H	0000 _H

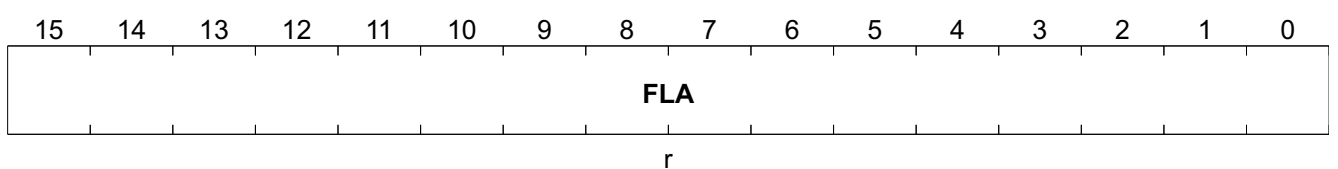

Field	Bits	Type	Description
FLA	15:0	r	First Lock Address [31:16]

First Lock Address [47:32]

FLA3	Offset	Reset Value
First Lock Address [47:32]	13E _H	0000 _H

16 Bits Mode Registers Description

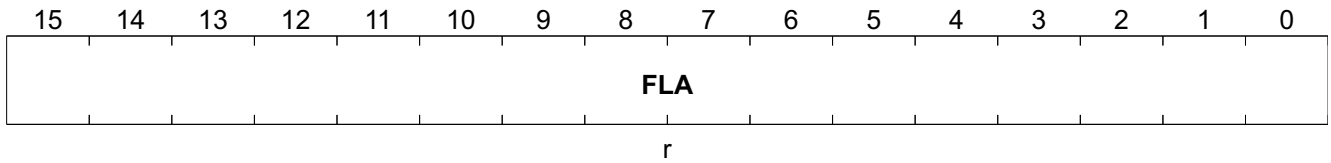

Field	Bits	Type	Description
FLA	15:0	r	First Lock Address [47:32]

First Lock FID

FLF	Offset	Reset Value
First Lock FID	13F_H	0000_H

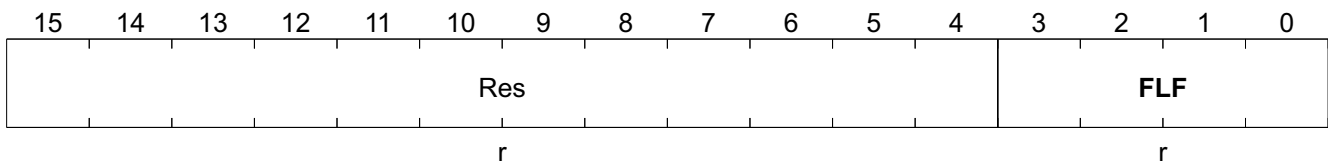

Field	Bits	Type	Description
Res	15:4	r	Reserved
FLF	3:0	r	First Lock FID

Counter Control Low Register

CCL	Offset	Reset Value
Counter Control Low Register	140_H	0000_H

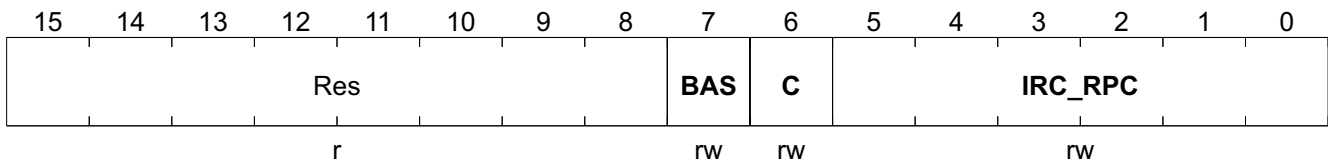

Field	Bits	Type	Description
Res	15:8	r	Reserved
BAS	7	rw	Busy/Access Start 0_B The counter control is free 1_B The counter control is busy, or users should write 1_B into this bit to start the access when the engine is free

16 Bits Mode Registers Description

Field	Bits	Type	Description
C	6	rw	Counter 0 _B Indirect Read Counter 1 _B Renew Port Counter
IRC_RPC	5:0	rw	Indirect Read Counter It means the counter address Renew Port Counter It means the counters on each port to renew

Counter Status Low Register

CSL	Offset	Reset Value
Counter Status Low Register	142_H	0000_H

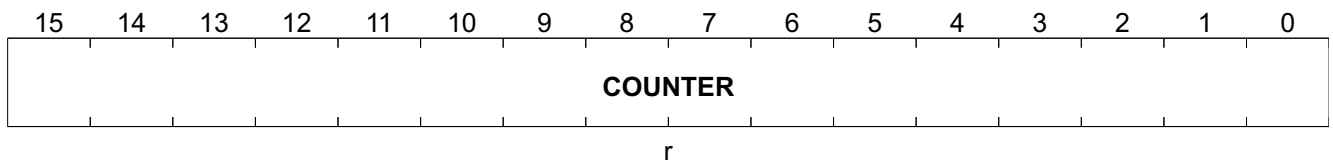

Field	Bits	Type	Description
COUNTER	15:0	r	Counter [15:0]

Counter Status High Register

CSH	Offset	Reset Value
Counter Status High Register	143_H	0000_H

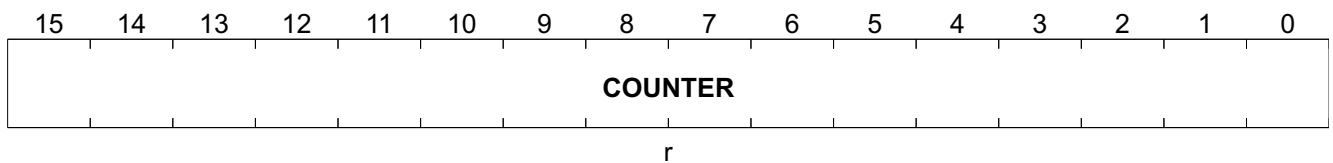

Field	Bits	Type	Description
COUNTER	15:0	r	Counter [31:16]

5.4 PHY Registers

PHY Control Register of Port 0

16 Bits Mode Registers Description

PHY_C0 **Offset**
PHY Control Register of Port 0 **200_H** **Reset Value**
3100_H

15	14	13	12	11	10	9	8	7	6	5	4	3	2	1	0
RST	LPBK	SPEED_L*	ANEN	PDN	ISO	ANEN_RST	DPLX	COLT ST	SPEED_M*	Res					
rwsc	rw	rw	rw	rw	rw	rwsc	rw	rw	ro						

Field	Bits	Type	Description
RST	15	rwsc	<p>RESET</p> <p>Setting this bit initiates the software reset function that resets the selected port, except for the phase-locked loop circuit. It will re-latch in all hardware configuration pin values. The software reset process takes 25 μs to complete. This bit, which is self-clearing, returns a value of 1 until the reset process is complete.</p> <p>0_B Normal operation 1_B PHY Reset</p>
LPBK	14	rw	<p>Loop Back Enable</p> <p>This bit controls the PHY loopback operation that isolates the network transmitter outputs (TXP and TXN) and routes the MII transmit data to the MII receive data path. This function should only be used when auto negotiation is disabled (bit 12 = 0). The specific PHY (10Base-T or 100Base-X) used for this operation is determined by bits 12 and 13 of this register.</p> <p>0_B Disable Loopback mode 1_B Enable loopback mode</p>
SPEED_LSB	13	rw	<p>Speed Selection LSB, 0.6, 0.13</p> <p>Link speed is selected by this bit or by auto negotiation if bit 12 of this register is set (in which case, the value of this bit is ignored). If it is fiber mode, 0.13 is always 1. Any write to this bit will have no effect.</p> <p>00_B 10 Mbit/s 01_B 100 Mbit/s 10_B 1000 Mbit/s 11_B Reserved</p>
ANEN	12	rw	<p>Auto Negotiation Enable</p> <p>This bit determines whether the link speed should be set up by the auto negotiation process or not. It is set at power up or reset if the RECANEN pin detects a logic 1 input level in Twisted-Pair Mode. If it is set when fiber mode is configured, any write to this bit will be ignored.</p> <p>0_B Disable Auto negotiation process 1_B Enable auto negotiation process</p>

16 Bits Mode Registers Description

Field	Bits	Type	Description
PDN	11	rw	<p>Power Down Enable</p> <p>Ored result with PI_PWRDN pin. Setting this bit high or asserting the PI_PWRDN puts the PHY into power down mode. During the power down mode, TXP/TXN and all LED outputs are tristated and the MII interfaces are isolated.</p> <p>0_B Normal Operation 1_B Power Down</p>
ISO	10	rw	<p>Isolate PHY from Network</p> <p>Setting this control bit isolates the part from the MII, with the exception of the serial management interface. When this bit is asserted, the PHY does not respond to TXD, TXEN and TXER inputs, and it presents a high impedance on its TXC, RXC, CRSDV, RXER, RXD, COL and CRS outputs.</p> <p>0_B Normal Operation 1_B Isolate PHY from MII</p>
ANEN_RST	9	rwsc	<p>Restart Auto Negotiation</p> <p>Setting this bit while auto negotiation is enabled forces a new auto negotiation process to start. This bit is self-clearing and returns to 0 after the auto negotiation process has commenced.</p> <p>0_B Normal Operation 1_B Restart Auto Negotiation Process</p>
DPLX	8	rw	<p>Duplex Mode</p> <p>If auto negotiation is disabled, this bit determines the duplex mode for the link.</p> <p>0_B Half Duplex mode 1_B Full Duplex mode</p>
COLTST	7	rw	<p>Collision Test</p> <p>When set, this bit will cause the COL signal of MII interface to be asserted in response to the assertion of TXEN.</p> <p>0_B Disable COL signal test 1_B Enable COL signal test</p>
SPEED_MSB	6	ro	<p>Speed Selection MSB</p> <p>Set to 0 all the time indicate that the PHY does not support 1000 Mbit/s function.</p>

Similar Registers

All PHY_Cx registers have the same structure and characteristics, see [PHY_C0](#).
The offset addresses of the other PHY_Cx registers are listed in [Table 47](#).

Table 47 PHY_Cx Registers

Register Short Name	Register Long Name	Offset Address	Page Number
PHY_C1	PHY Control Register of Port 1	220 _H	
PHY_C2	PHY Control Register of Port 2	240 _H	
PHY_C3	PHY Control Register of Port 3	260 _H	
PHY_C4	PHY Control Register of Port 4	280 _H	

16 Bits Mode Registers Description

PHY Status Register of Port 0

PHY_S0 Offset
PHY Status Register of Port 0 201_H Reset Value
7849_H

15	14	13	12	11	10	9	8	7	6	5	4	3	2	1	0
CAP_T4	CAP_TXF	CAP_TXH	CAP_TF	CAP_TH	CAP_T2	Res			CAP_SUPR	AN_COMP	REM_FLT	CAP_ANEG	LINK	JAB	EXTR EG
ro	ro	ro	ro	ro	ro				ro	ro	ro	ro	ro	ro	ro

Field	Bits	Type	Description
CAP_T4	15	ro	100Base-T4 Capable Set to 0 all the time to indicate that the PHY does not support 100Base-T4
CAP_TXF	14	ro	100Base-X Full Duplex Capable Set to 1 all the time to indicate that the PHY does support Full Duplex mode
CAP_TXH	13	ro	100Base-X Half Duplex Capable Set to 1 all the time to indicate that the PHY does support Half Duplex mode
CAP_TF	12	ro	10M Full Duplex Capable TP : Set to 1 all the time to indicate that the PHY does support 10M Full Duplex mode FX : Set to 0 all the time to indicate that the PHY does not support 10M Full Duplex mode
CAP_TH	11	ro	10M Half Duplex Capable TP : Set to 1 all the time to indicate that the PHY does support 10M Half Duplex mode FX : Set to 0 all the time to indicate that the PHY does not support 10M Half Duplex mode
CAP_T2	10	ro	100Base-T2 Capable Set to 0 all the time to indicate that the PHY does not support 100Base-T2
CAP_SUPR	6	ro	MF Preamble Suppression Capable This bit is hardwired to 1 indicating that the PHY accepts management frame without preamble. Minimum 32 preamble bits are required following power-on or hardware reset. One idle bit is required between any two management transactions as per IEEE 802.3u specification.
AN_COMP	5	ro	Auto Negotiation Complete If auto negotiation is enabled, this bit indicates whether the auto negotiation process has been completed or not. Set to 0 all the time when Fiber Mode is selected. 0 _B Auto Negotiation process not completed 1 _B Auto Negotiation process completed

16 Bits Mode Registers Description

Field	Bits	Type	Description
REM_FLT	4	ro	Remote Fault Detect This bit is latched to 1 if the RF bit in the auto negotiation link partner ability register (bit 13, register address 05 _H) is set or the receive channel meets the far end fault indication function criteria. It is unlatched when this register is read. 0 _B Remote Fault not detected 1 _B Remote Fault detected
CAP_ANEG	3	ro	Auto Negotiation Ability TP : This bit is set to 1 all the time, indicating that PHY is capable of auto negotiation. FX : This bit is set to 0 all the time, indicating that PHY is not capable of auto negotiation in Fiber Mode. 0 _B Not capable of auto negotiation 1 _B Capable of auto negotiation
LINK	2	ro	Link Status This bit reflects the current state of the link – test-fail state machine. Loss of a valid link causes a 0 latched into this bit. It remains 0 until this register is read by the serial management interface. Whenever Linkup, this bit should be read twice to get link up status 0 _B Link is down 1 _B Link is up
JAB	1	ro	Jabber Detect 0 _B Jabber condition not detected 1 _B Jabber condition detected
EXTREG	0	ro	Extended Capability This bit defaults to 1, indicating that the PHY implements extended registers. 0 _B No extended register set 1 _B Extended register set

Similar Registers

All PHY_Sx registers have the same structure and characteristics, see [PHY_S0](#). The offset addresses of the other PHY_Sx registers are listed in [Table 48](#).

Table 48 PHY_Sx Registers

Register Short Name	Register Long Name	Offset Address	Page Number
PHY_S1	PHY Status Register of Port 1	221 _H	
PHY_S2	PHY Status Register of Port 2	241 _H	
PHY_S3	PHY Status Register of Port 3	261 _H	
PHY_S4	PHY Status Register of Port 4	281 _H	

PHY Identifier Register of Port 0 (A)

PHY_I0_A	Offset	Reset Value
PHY Identifier Register of Port 0 (A)	202_H	0302_H

16 Bits Mode Registers Description

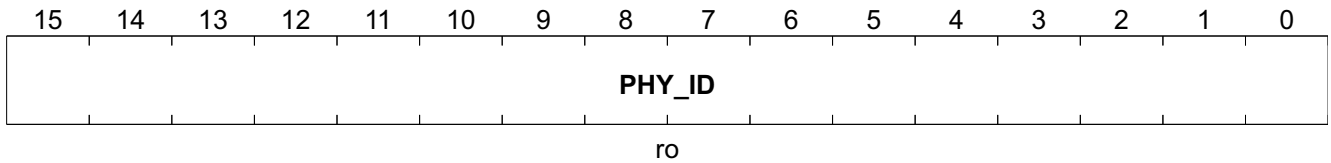

Field	Bits	Type	Description
PHY_ID	15:0	ro	IEEE Address

Similar Registers

All PHY_Ix_A registers have the same structure and characteristics, see [PHY_I0_A](#).
The offset addresses of the other PHY_Ix_A registers are listed in [Table 49](#).

Table 49 PHY_Ix_A Registers

Register Short Name	Register Long Name	Offset Address	Page Number
PHY_I1_A	PHY Identifier Register of Port 1 (A)	222 _H	
PHY_I2_A	PHY Identifier Register of Port 2 (A)	242 _H	
PHY_I3_A	PHY Identifier Register of Port 3 (A)	262 _H	
PHY_I4_A	PHY Identifier Register of Port 4 (A)	282 _H	

PHY Identifier Register of Port 0 (B)

PHY_I0_B	Offset	Reset Value
PHY Identifier Register of Port 0 (B)	203 _H	6071 _H

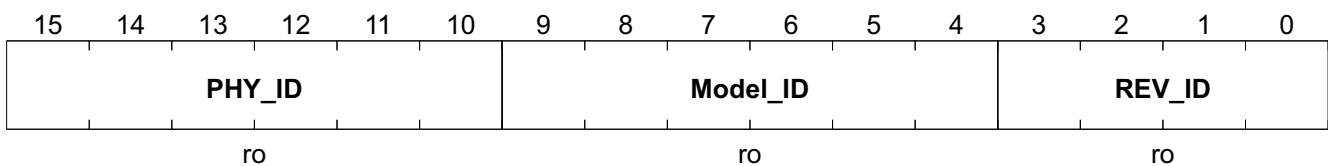

Field	Bits	Type	Description
PHY_ID	15:10	ro	IEEE Address
Model_ID	9:4	ro	IEEE Model No.
REV_ID	3:0	ro	IEEE Revision No.

Similar Registers

All PHY_Ix_B registers have the same structure and characteristics, see [PHY_I0_B](#).
The offset addresses of the other PHY_Ix_B registers are listed in [Table 50](#).

Table 50 PHY_Ix_B Registers

Register Short Name	Register Long Name	Offset Address	Page Number
PHY_I1_B	PHY Identifier Register of Port 1 (B)	223 _H	
PHY_I2_B	PHY Identifier Register of Port 2 (B)	243 _H	

Table 50 PHY_Ix_B Registers (cont'd)

Register Short Name	Register Long Name	Offset Address	Page Number
PHY_I3_B	PHY Identifier Register of Port 3 (B)	263 _H	
PHY_I4_B	PHY Identifier Register of Port 4 (B)	283 _H	

Auto Negotiation Advertisement Register of Port 0

ANAP0 **Offset**
Auto Negotiation Advertisement Register of **204_H**
Port 0 **Reset Value**
05E1_H

15	14	13	12	11	10	9	8	7	6	5	4	3	2	1	0
NP	Res	RF	Res	ASM DIR	PAUSE	T4	TX_FDX	TX_HDX	10_FDX	10_HDX			SF		
ro		ro		rw	rw	ro	rw	rw	rw	rw			ro		

Field	Bits	Type	Description
NP	15	ro	Next Page This bit is defaults to 1, indicating that PHY is next page capable
RF	13	ro	Remote Fault This bit is written by serial management interface for the purpose of communicating the remote fault condition to the auto negotiation link partner. 0 _B No remote fault has been detected 1 _B Remote Fault has been detected
ASM_DIR	11	rw	Asymmetric Pause Direction Bit[11:10] Capability 00 _B No Pause 01 _B Symmetric PAUSE 10 _B Asymmetric PAUSE toward Link Partner 11 _B Both Symmetric PAUSE and Asymmetric PAUSE toward local device
PAUSE	10	rw	Pause Operation for Full Duplex Value on PAUREC will be stored in this bit during power on reset.
T4	9	ro	Technology Ability for 100Base-T4 Defaults to 0.
TX_FDX	8	rw	100Base-TX Full Duplex 0 _B Not capable of 100M Full duplex operation 1 _B Capable of 100M Full duplex operation
TX_HDX	7	rw	100Base-TX Half Duplex 0 _B Not capable of 100M operation 1 _B Capable of 100M operation
10_FDX	6	rw	10BASE-T Full Duplex 0 _B Not capable of 10M full duplex operation 1 _B Capable of 10M Full Duplex operation

16 Bits Mode Registers Description

Field	Bits	Type	Description
10_HDX	5	rw	10Base-T Half Duplex <i>Note: Bit 8:5 should be combined with REC100, RECFUL pin input to determine the finalized speed and duplex mode.</i> 0 _B Not capable of 10M operation 1 _B Capable of 10M operation
SF	4:0	ro	Selector Field These 5 bits are hardwired to 00001 _B , indicating that the PHY supports IEEE 802.3 CSMA/CD.

Similar Registers

All ANAPx registers have the same structure and characteristics, see [ANAP0](#).
The offset addresses of the other ANAPx registers are listed in [Table 51](#).

Table 51 ANAPx Registers

Register Short Name	Register Long Name	Offset Address	Page Number
ANAP1	Auto Negotiation Advertisement Register of Port 1	224 _H	
ANAP2	Auto Negotiation Advertisement Register of Port 2	244 _H	
ANAP3	Auto Negotiation Advertisement Register of Port 3	264 _H	
ANAP4	Auto Negotiation Advertisement Register of Port 4	284 _H	

Auto Negotiation Link Partner Ability Register of Port 0

ANLPA0	Offset	Reset Value
Auto Negotiation Link Partner Ability Register of Port 0	205_H	01E1_H

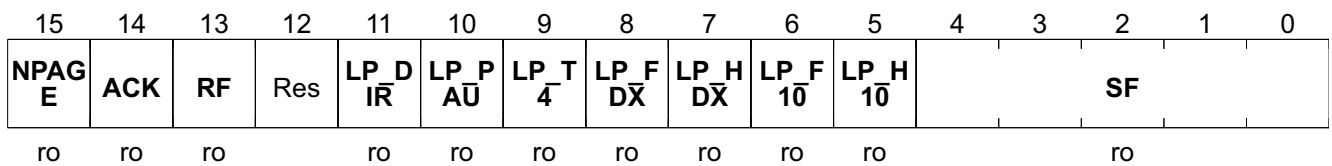

Field	Bits	Type	Description
NPAGE	15	ro	Next Page 0 _B Not capable of next page function 1 _B Capable of next page function
ACK	14	ro	Acknowledge 0 _B Not acknowledged 1 _B Link Partner acknowledges reception of the ability data word
RF	13	ro	Remote Fault 0 _B No remote fault has been detected 1 _B Remote Fault has been detected
LP_DIR	11	ro	Link Partner Asymmetric Pause Direction

16 Bits Mode Registers Description

Field	Bits	Type	Description
LP_PAU	10	ro	Link Partner Pause Capability Value on PAUREC Will be stored in this bit during power on reset.
LP_T4	9	ro	Link Partner Technology Ability For 100Base-T4 Defaults to 0.
LP_FDX	8	ro	100Base-TX Full Duplex 0 _B Not capable of 100M Full duplex operation 1 _B Capable of 100M Full duplex operation
LP_HDX	7	ro	100Base-TX Half Duplex 0 _B Not capable of 100M operation 1 _B Capable of 100M operation
LP_F10	6	ro	10BASE-T Full Duplex 0 _B Not capable of 10M full duplex operation 1 _B Capable of 10M Full Duplex operation
LP_H10	5	ro	10Base-T Half Duplex 0 _B Not capable of 10M operation 1 _B Capable of 10M operation
SF	4:0	ro	Selector Field Encoding Definitions

Similar Registers

All ANLPAx registers have the same structure and characteristics, see [ANLPA0](#).
The offset addresses of the other ANLPAx registers are listed in [Table 52](#).

Table 52 ANLPAx Registers

Register Short Name	Register Long Name	Offset Address	Page Number
ANLPA1	Auto Negotiation Link Partner Ability Register of Port 1	225 _H	
ANLPA2	Auto Negotiation Link Partner Ability Register of Port 2	245 _H	
ANLPA3	Auto Negotiation Link Partner Ability Register of Port 3	265 _H	
ANLPA4	Auto Negotiation Link Partner Ability Register of Port 4	285 _H	

Auto Negotiation Expansion Register of Port 0

ANE0	Offset	Reset Value
Auto Negotiation Expansion Register of Port 0	206_H	0000_H

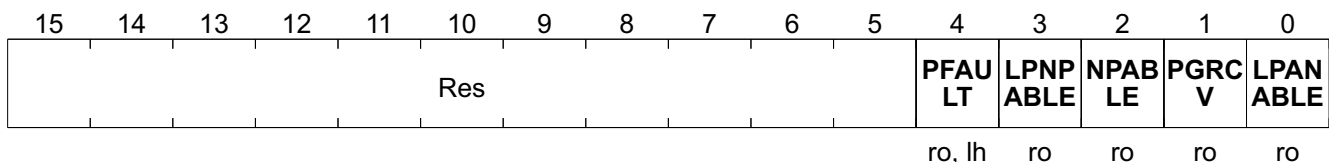

16 Bits Mode Registers Description

Field	Bits	Type	Description
PFAULT	4	ro, lh	Parallel Detection Fault 0 _B No Fault Detect 1 _B Fault has been detected
LPNPABLE	3	ro	Link Partner Next Page Able 0 _B Link Partner is not next page capable 1 _B Link Partner is next page capable
NPABLE	2	ro	Next Page Able Defaults to 0, indicating PHY is not capable of next page.
PGRCV	1	ro	Page Received 0 _B No new page has been received 1 _B A new page has been received
LPANABLE	0	ro	Link Partner Auto Negotiation Able 0 _B Link Partner is not auto negotiable 1 _B Link Partner is auto negotiable

Similar Registers

All ANEx registers have the same structure and characteristics, see [ANE0](#).
The offset addresses of the other ANEx registers are listed in [Table 53](#).

Table 53 ANEx Registers

Register Short Name	Register Long Name	Offset Address	Page Number
ANE1	Auto Negotiation Expansion Register of Port 1	226 _H	
ANE2	Auto Negotiation Expansion Register of Port 2	246 _H	
ANE3	Auto Negotiation Expansion Register of Port 3	266 _H	
ANE4	Auto Negotiation Expansion Register of Port 4	286 _H	

Next Page Transmit Register of Port 0

NPT0	Offset	Reset Value
Next Page Transmit Register of Port 0	207_H	2001_H

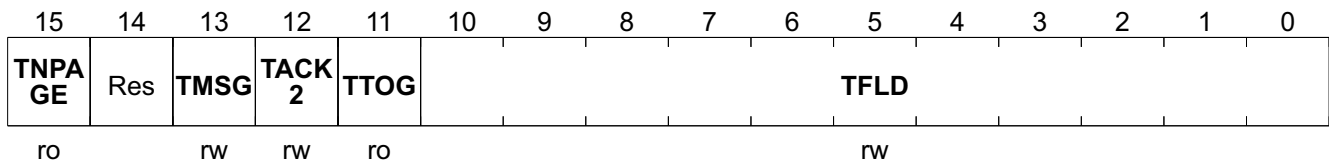

Field	Bits	Type	Description
TNPAGE	15	ro	Transmit Next Page Transmit Code Word Bit 15
TMSG	13	rw	Transmit Message Page Transmit Code Word Bit 13

16 Bits Mode Registers Description

Field	Bits	Type	Description
TACK2	12	rw	Transmit Acknowledge 2 Transmit Code Word Bit 12
TTOG	11	ro	Transmit Toggle Transmit Code Word Bit 11
TFLD	10:0	rw	Transmit Message Field Transmit Code Word Bit 10..0

Similar Registers

All NPTx registers have the same structure and characteristics, see [NPT0](#).
The offset addresses of the other NPTx registers are listed in [Table 54](#).

Table 54 NPTx Registers

Register Short Name	Register Long Name	Offset Address	Page Number
NPT1	Next Page Transmit Register of Port 1	227 _H	
NPT2	Next Page Transmit Register of Port 2	247 _H	
NPT3	Next Page Transmit Register of Port 3	267 _H	
NPT4	Next Page Transmit Register of Port 4	287 _H	

Link Partner Next Page Register of Port 0

LPNP0	Offset	Reset Value
Link Partner Next Page Register of Port 0	208_H	0000_H

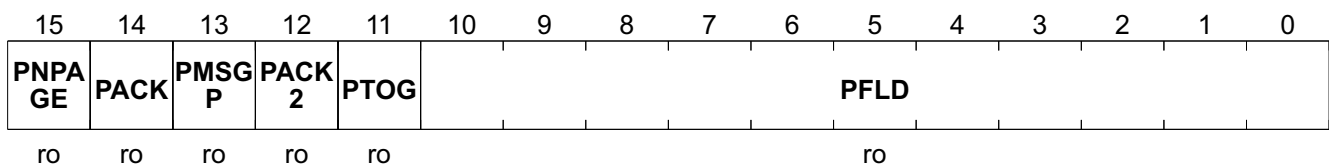

Field	Bits	Type	Description
PNPAGE	15	ro	Link Partner Next Page Receive Code Word Bit 15
PACK	14	ro	Link Partner Acknowledge Receive Code Word Bit 14
PMSGP	13	ro	Link Partner Message Page Receive Code Word Bit 13
PACK2	12	ro	Link Partner Acknowledge 2 Receive Code Word Bit 12
PTOG	11	ro	Link Partner Toggle Receive Code Word Bit 11
PFLD	10:0	ro	Link Partner Message Field Receive Code Word Bit 11

Similar Registers

All LPNPx registers have the same structure and characteristics, see [LPNP0](#).
The offset addresses of the other LPNPx registers are listed in [Table 55](#).

Table 55 LPNPx Registers

Register Short Name	Register Long Name	Offset Address	Page Number
LPNP1	Link Partner Next Page Register of Port 1	228 _H	
LPNP2	Link Partner Next Page Register of Port 2	248 _H	
LPNP3	Link Partner Next Page Register of Port 3	268 _H	
LPNP4	Link Partner Next Page Register of Port 4	288 _H	

6 Hardware, EEPROM and SMI Interface for Configuration

Three ways are supported to configure the setting in the ADM6996LC/LCX/LHX: (1) Hardware Setting (2) EEPROM Interface (3) SMI Interface. Users could use EEPROM and SMI interfaces combined with the CPU port to provide proprietary functions. Four pins are needed when using these two interfaces. See [Figure 14](#) for the description.

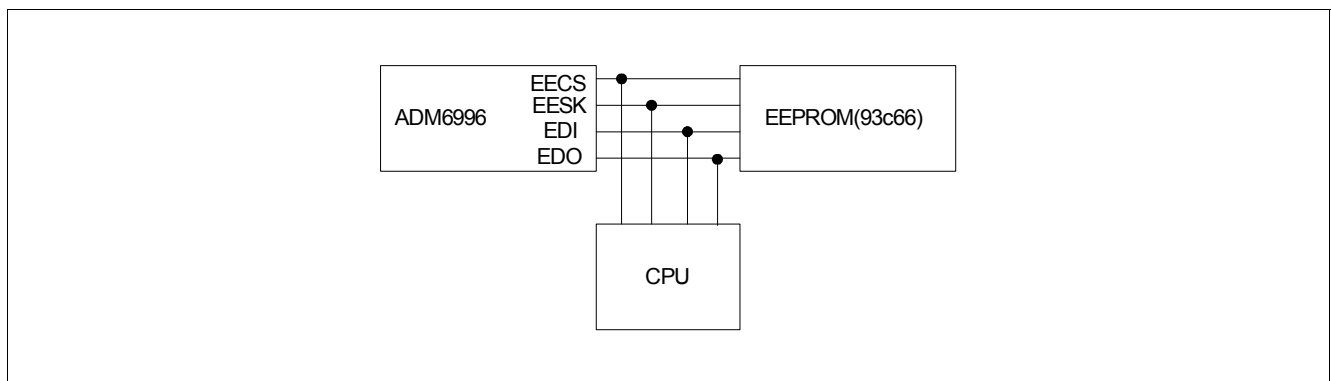

Figure 14 Interconnection between ADM6996LC/LCX/LHX, EEPROM and CPU

6.1 Hardware Setting

The ADM6996LC/LCX/LHX provides some hardware pins, where values reside on will be strapped for the default setting during the power on or reset.

Table 56 Hardware Setting

Setting Name	Description
GFCEN	Global Flow Control Enable. 0 _B Flow Control Capability is depended upon the register setting in corresponding EEPROM register 1 _B All ports flow control capability is enabled.
SDIO_MD	SDC/SDIO mode selection. 0 _B 16 bits mode 1 _B 32 bits mode

Table 56 Hardware Setting (cont'd)

Setting Name	Description
P5_BUSMD[1:0]	Port 5 bus mode selection bit 0. P5_BUSMD[1:0] ,Interface 00 _B MII 01 _B GPSI 10 _B RMII 11 _B Reserved and Not Allowed.
BPEN	Recommend Back-Pressure in half-duplex. 0 _B Disable Back-Pressure. 1 _B Enable Back-Pressure
RECANEN	Recommend Auto Negotiation Enable. Only valid for Twisted pair interface. Programmed this bit to 1 has no effect to Fiber port. 0 _B Disable all TP port auto negotiation capability 1 _B Enable all TP port auto negotiation capability
XOVEN	Cross Over Enable. Only available in TP interface. 0 _B Disable 1 _B Enable
LED_MODE	Enable Mac to choose LED Display Mode. 0 _B Single color LED 1 _B Dual color LED

6.2 EEPROM Interface

The EEPROM Interface is provided so the users could easily configure the setting without CPU's help. Because the EEPROM Interface is the same as the 93c66, it also allows the CPU to write the EEPROM register and renew the 93c66 at the same time. After the power up or reset (default value from the hardware pins fetched in this stage), the ADM6996LC/LCX/LHX will automatically detect the presence of the EEPROM by reading the address 0 in the 93c66. If the value = 4154_H, it will load all the data in the 93c66. If not, the ADM6996LC/LCX/LHX will stop loading the 93c66. The user also could pull down the EDO to force the ADM6996LC/LCX/LHX not to load the 93c66. The 93c66 loading time is around 30ms. Then CPU should drive the high-z value in the EECs, EESK and EDI pins in this period if existing the CPU to read or write the registers in the ADM6996LC/LCX/LHX.

The EEPROM Interface needs only one Write command to complete a "Write" operation to the ADM6996LC/LCX/LHX. If users would like to update the 93c66 at the same time, then three commands, Write Enable, Write, and Write Disable, are needed to complete this operation (See 93c66 Spec. for the reference). User should note that the EEPROM interface only allows the CPU to write the EEPROM register in the ADM6996LC/LCX/LHX and doesn't support the READ command. If CPU sends out the Read Command, then 93c66 will respond with the value inside, instead of ADM6996LC/LCX/LHX. Users should also note that one additional EESK cycle is needed between any continuous commands (Read or Write).

(1) Read 93c66 via the EEPROM Interface (Index = 2, Data = 1111_H).

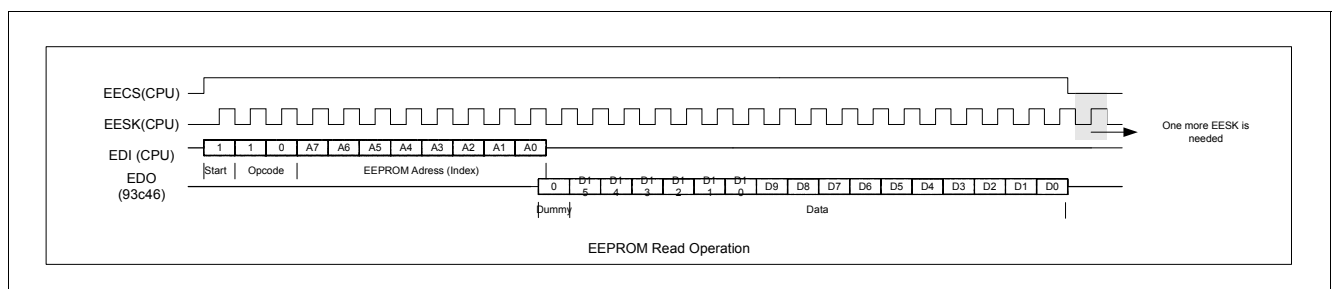

Hardware, EEPROM and SMI Interface for Configuration

(2) Write EEPROM registers in the ADM6996LC/LCX/LHX (Index = 2, Data = 16'h2222).

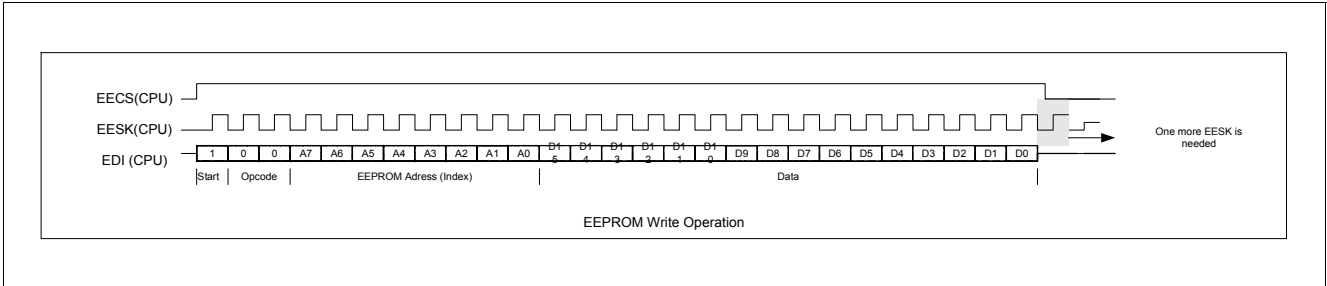

6.3 SMI Interface

The SMI consists of two pins, management data clock (EESK) and management data input/output (EDI). The ADM6996LC/LCX/LHX is designed to support an EESK frequency up to 25 MHz. The EDI pin is bi-directional and may be shared with other devices. EECs pin is needed to pull low if EEPROM interface is also used.

The EDI pin requires a 1.5 KΩ pull-up which, during idle and turnaround periods, will pull EDI to a logic one state. ADM6996LC/LCX/LHX requires a single initialization sequence of 32 bits of preamble following power-up/hardware reset. The first 32 bits are preamble consisting of 32 contiguous logic one bits on EDI and 32 corresponding cycles on EESK. Following preamble is the start-of-frame field indicated by a <01_B> pattern. The next field signals the operation code (OP): <10_B> indicates read from management register operation, and <01_B> indicates write to management register operation. The next field is the management register address. It is 10 bits wide and the most significant bit is transferred first.

During Read operation, a 2-bit turn around (TA) time spacing between the register address field and data field is provided for the EDI to avoid contention. Following the turnaround time, a 16-bit data stream is read from or written into the management registers of the ADM6996LC/LCX/LHX.

(A) Preamble Suppression

The SMI of ADM6996LC/LCX/LHX supports a preamble suppression mode. The ADM6996LC/LCX/LHX requires a single initialization sequence of 32 bits of preamble following power-up/hardware reset. This requirement is generally met by pulling-up the resistor of EDI. While the ADM6996LC/LCX/LHX will respond to management accesses without preamble, a minimum of one idle bit between management transactions is required.

When ADM6996LC/LCX/LHX detects that there is address match, then it will enable Read/Write capability for external access. When address is mismatched, then ADM6996LC/LCX/LHX will tri-state the EDI pin.

(B) Read Switch Register via SMI Interface (Offset Hex = 10'h2, Data = 16'h2600)

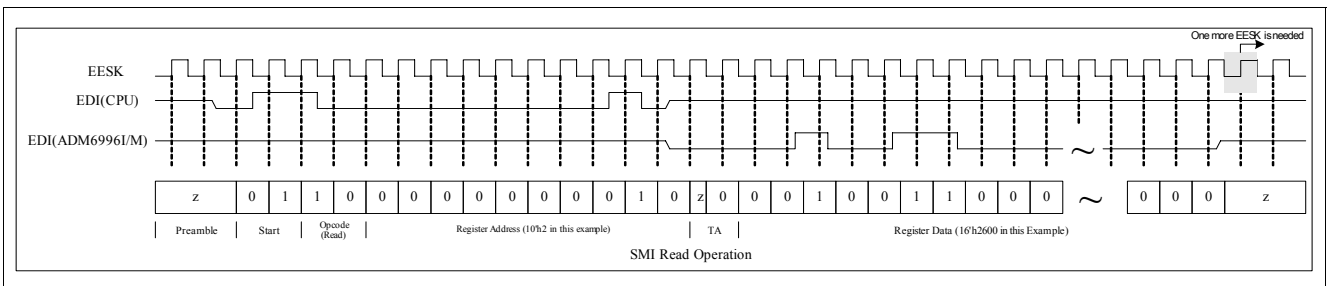

(C) Write Switch Register via SMI Interface (Offset Hex = 10'h180, Data = 16'h1300)

Hardware, EEPROM and SMI Interface for Configuration

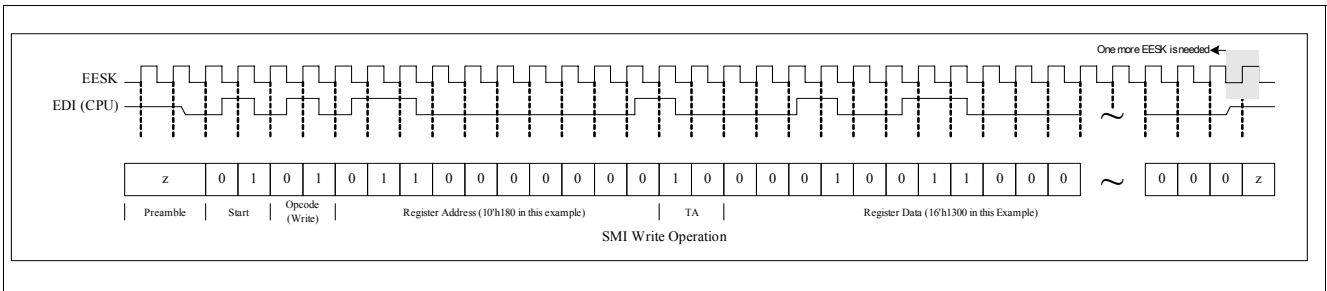

Table 57 (D) The Pin Type of EECS, EESK, EDI and EDO during the Operation

Pin Name	Reset Operation	Load EEPROM	Write Operation	Read Operation
EECS	Input	Output	Input	Input
EESK	Input	Output	Input	Input
EDI	Input	Output	Input	Input/Output
EDO	Input	Input	Input	Input

7 Electrical Specification

7.1 TX/FX Interface

7.1.1 TP Interface

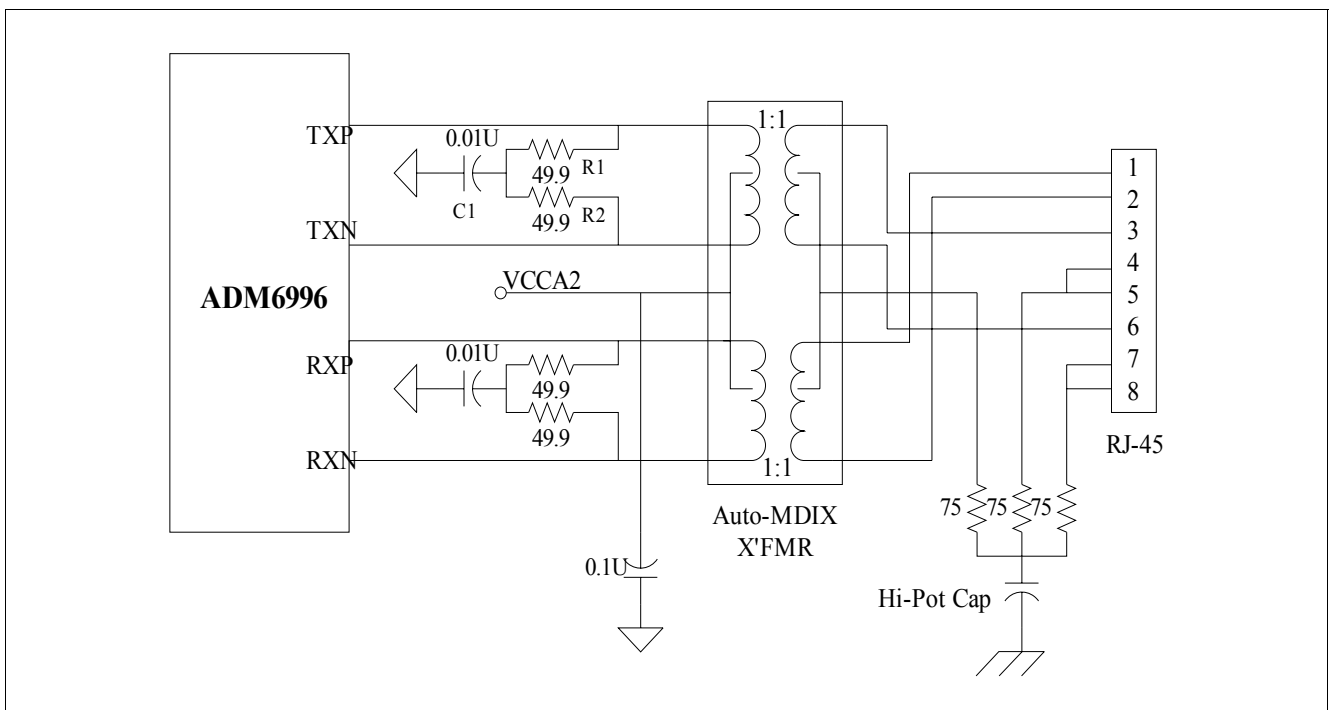

Figure 15 TP Interface

Transformer requirements:

- TX/RX rate 1:1
- TX/RX central tap connect together to VCCA2

Users can change the TX/RX pin for easy layout but do not change the polarity. ADM6996LC/LCX/LHX supports auto polarity on the receiving side.

7.1.2 FX Interface

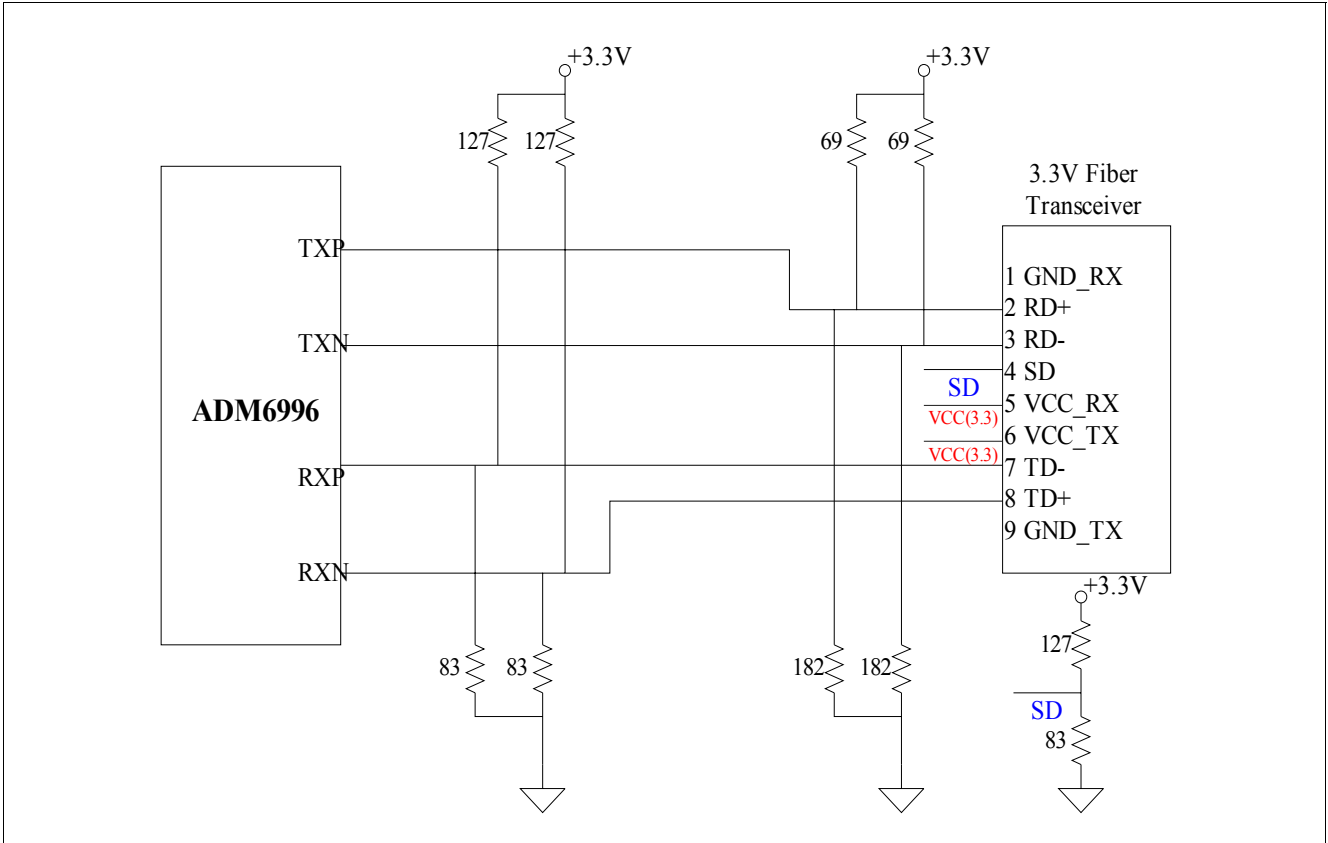

Figure 16 FX Interface

7.2 DC Characterization

Table 58 Power Consumption

Parameter	Symbol	Values			Unit	Note / Test Condition
		Min.	Typ.	Max.		
Power consumption when all twisted pair ports are linked at 100 Mbit/s.	P_{100M_5TP}	—	980	—	mW	Under EEPROM Register 29 _H = C000 _H , and 30 _H = 985 _H
Power consumption when all twisted pair ports are linked at 10 Mbit/s (include transformer).	P_{10M_5TP}	—	1450	—	mW	Under EEPROM Register 29 _H = C000 _H , and 30 _H = 985 _H
Power consumption when all twisted pair ports are disconnected.	P_{DIS_5TP}	—	500	—	mW	Under EEPROM Register 29 _H = C000 _H , and 30 _H = 985 _H

Table 59 Absolute Maximum Ratings

Parameter	Symbol	Values			Unit	Note / Test Condition
		Min.	Typ.	Max.		
3.3 V Power Supply for I/O pad	V_{CC30}	2.97	3.3	3.63	V	–
3.3 V Power Supply for bias circuit	V_{CCBS}	2.97	3.3	3.63	V	–
3.3 V Power Supply for A/D converter	V_{CCAD}	2.97	3.3	3.63	V	–
1.8 V Power Supply for line driver	V_{CCA2}	1.62	1.8	1.98	V	–
1.8 V Power Supply for PLL	V_{CCPLL}	1.62	1.8	1.98	V	–
1.8 V Power Supply for Digital core	V_{CCIK}	1.62	1.8	1.98	V	–
Input Voltage	V_{IN}	-0.3	–	$V_{CC30} + 0.3$	V	–
Output Voltage	V_{out}	-0.3	–	$V_{CC30} + 0.3$	V	–
Maximum current for 3.3 V power supply	$I_{3.3VMAX}$	–	–	100	mA	–
Maximum current for 1.8 V power supply (include transformer)	$I_{1.8VMAX}$	–	–	800	mA	–
Storage Temperature	T_{STG}	-55	–	155	°C	–
ESD Rating	ESD	1.0	–	–	kV	–

Attention: Stresses above the max. values listed here may cause permanent damage to the device. Exposure to absolute maximum rating conditions for extended periods may affect device reliability. Maximum ratings are absolute ratings; exceeding only one of these values may cause irreversible damage to the integrated circuit.

Table 60 Recommended Operating Conditions

Parameter	Symbol	Values			Unit	Note / Test Condition
		Min.	Typ.	Max.		
3.3 V Power Supply for I/O pad	V_{CC30}	3.135	3.3	3.465	V	–
3.3 V Power Supply for bias circuit	V_{CCBS}	3.135	3.3	3.465	V	–
3.3 V Power Supply for A/D converter	V_{CCAD}	3.135	3.3	3.465	V	–
1.8 V Power Supply for line driver	V_{CCA2}	1.71	1.8	1.89	V	–
1.8 V Power Supply for PLL	V_{CCPLL}	1.71	1.8	1.89	V	–
1.8 V Power Supply for Digital core	V_{CCIK}	1.71	1.8	1.89	V	–
Input Voltage	V_{in}	0	–	V_{CC}	V	–
Junction Operating Temperature	T_j	0	25	115	°C	–

Table 61 DC Electrical Characteristics for 3.3 V Operation¹⁾

Parameter	Symbol	Values			Unit	Note / Test Condition
		Min.	Typ.	Max.		
Input Low Voltage	V_{IL}	–	–	0.8	V	TTL
Input High Voltage	V_{IH}	2.0	–	–	V	TTL
Output Low Voltage	V_{OL}	–	–	0.4	V	TTL
Output High Voltage	V_{OH}	2.4	–	–	V	TTL
Input Pull-up/down Resistance	R_I	–	50	–	k Ω	$V_{IL} = 0\text{ V}$ or $V_{IH} = V_{cc3o}$

1) Under $V_{cc3o} = 2.97\text{V} \sim 3.63\text{V}$, $T_j = 0\text{ }^\circ\text{C} \sim 115\text{ }^\circ\text{C}$

7.3 AC Characterization

7.3.1 XTAL/OSC Timing

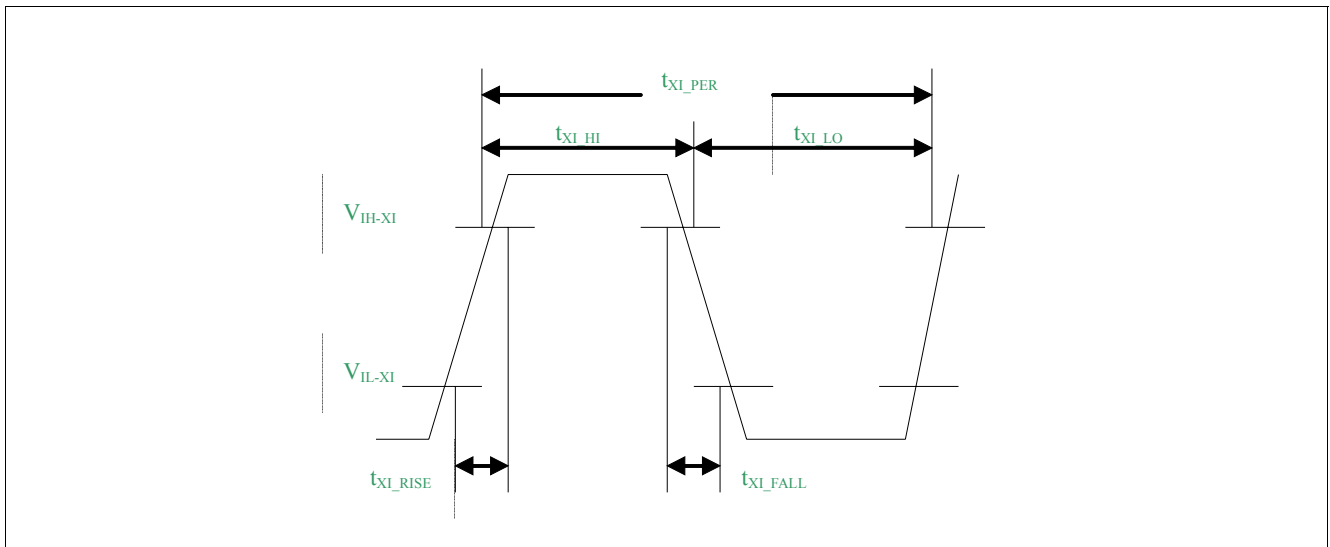

Figure 17 XTAL/OSC Timing

Table 62 XTAL/OSC Timing

Parameter	Symbol	Values			Unit	Note / Test Condition
		Min.	Typ.	Max.		
XI/OSCI Clock Period	t_{XI_PER}	40.0 - 50ppm	40.0	40.0 + 50ppm	ns	–
XI/OSCI Clock High	t_{XI_HI}	14	20.0	–	ns	–
XI/OSCI Clock Low	t_{XI_LO}	14	20.0	–	ns	–
XI/OSCI Clock Rise Time, V_{IL} (max) to V_{IH} (min.)	t_{XI_RISE}	–	–	4	ns	–
XI/OSCI Clock Fall Time, V_{IH} (min.) to V_{IL} (max)	t_{XI_FALL}	–	–	4	ns	–

7.3.2 Power On Reset

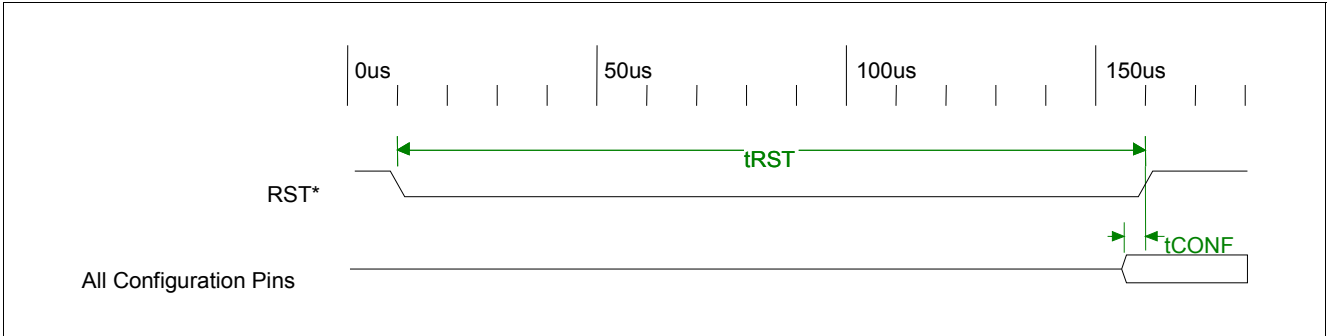

Figure 18 Power On Reset Timing

Table 63 Power On Reset Timing

Parameter	Symbol	Values			Unit	Note / Test Condition
		Min.	Typ.	Max.		
RST Low Period	t_{RST}	100	–	–	ms	–
Start of Idle Pulse Width	t_{CONF}	100	–	–	ns	–

7.3.3 EEPROM Interface Timing

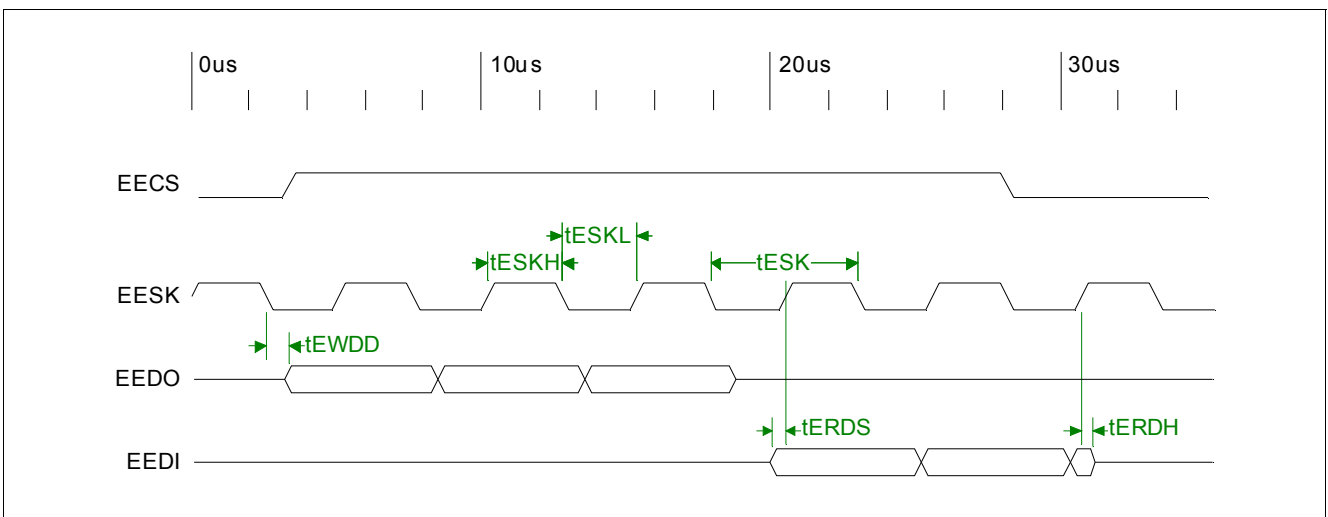

Figure 19 EEPROM Interface Timing

Table 64 EEPROM Interface Timing

Parameter	Symbol	Values			Unit	Note / Test Condition
		Min.	Typ.	Max.		
EESK Period	t_{ESK}	–	5120	–	ns	–
EESK Low Period	t_{ESKL}	2550	–	2570	ns	–
EESK High Period	t_{ESKH}	2550	–	2570	ns	–

Table 64 EEPROM Interface Timing (cont'd)

Parameter	Symbol	Values			Unit	Note / Test Condition
		Min.	Typ.	Max.		
EEDI to EESK Rising Setup Time	t_{ERDS}	10	–	–	ns	–
EEDI to EESK Rising Hold Time	t_{ERDH}	10	–	–	ns	–
EESK Falling to EEDO Output Delay Time	t_{EWDD}	–	–	20	ns	–

7.3.4 10Base-TX MII Input Timing

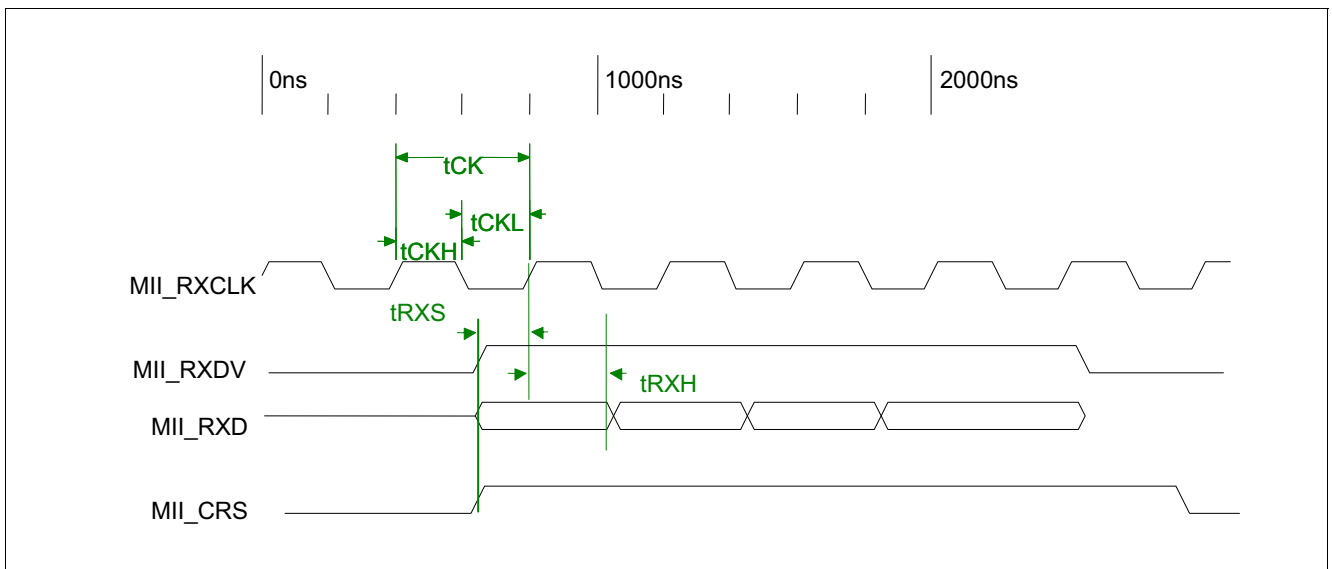

Figure 20 10Base-TX MII Input Timing

Table 65 10Base-TX MII Input Timing

Parameter	Symbol	Values			Unit	Note / Test Condition
		Min.	Typ.	Max.		
MII_RXCLK Period	t_{CK}	–	400	–	ns	–
MII_RXCLK Low Period	t_{CKL}	180	–	220	ns	–
MII_RXCLK High Period	t_{CKH}	180	–	220	ns	–
MII_CRD, MII_RXDV and MII_RXD to MII_RXCLK rising setup	t_{RXS}	10	–	–	ns	–
MII_CRD, MII_RXDV and MII_RXD to MII_RXCLK rising hold	t_{RXH}	10	–	–	ns	–

7.3.5 10Base-TX MII Output Timing

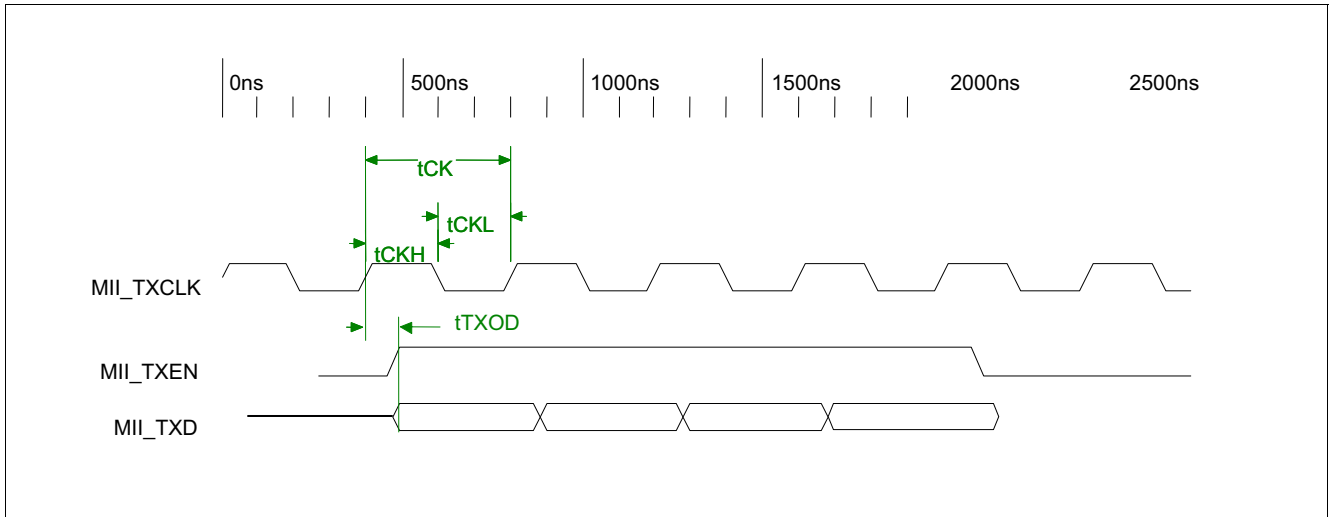

Figure 21 10Base-TX MII Output Timing

Table 66 10-Base-TX MII Output Timing

Parameter	Symbol	Values			Unit	Note / Test Condition
		Min.	Typ.	Max.		
MII_TXCLK Period	t_{CK}	–	400	–	ns	–
MII_TXCLK Low Period	t_{CKL}	180	–	220	ns	–
MII_TXCLK High Period	t_{CKH}	180	–	220	ns	–
MII_TXD, MII_TXEN to MII_TXCLK Rising Output Delay	t_{TXOD}	0	–	25	ns	–

7.3.6 100Base-TX MII Input Timing

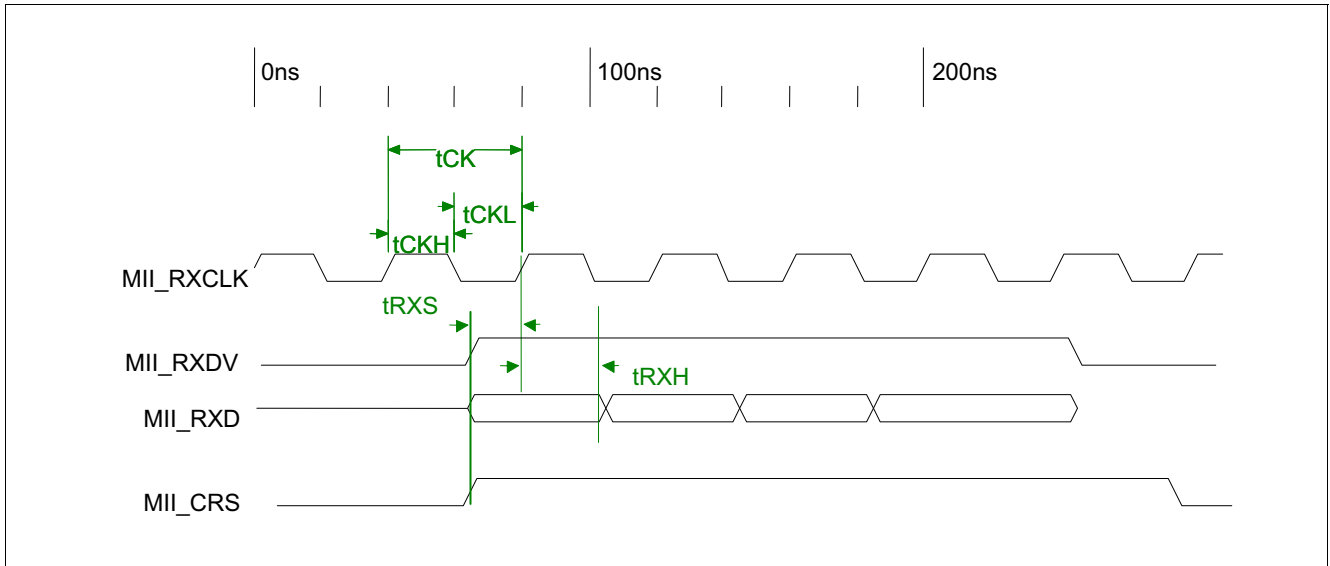

Figure 22 100Base-TX MII Input Timing

Table 67 100Base-TX MII Input Timing

Parameter	Symbol	Values			Unit	Note / Test Condition
		Min.	Typ.	Max.		
MII_RXCLK Period	t_{CK}	–	40	–	ns	–
MII_RXCLK Low Period	t_{CKL}	18	–	22	ns	–
MII_RXCLK High Period	t_{CKH}	18	–	22	ns	–
MII_CRS, MII_RXDV and MII_RXD to MII_RXCLK rising setup	t_{RXS}	10	–	–	ns	–
MII_CRS, MII_RXDV and MII_RXD to MII_RXCLK rising hold	t_{RXH}	10	–	–	ns	–

7.3.7 100Base-TX MII Output Timing

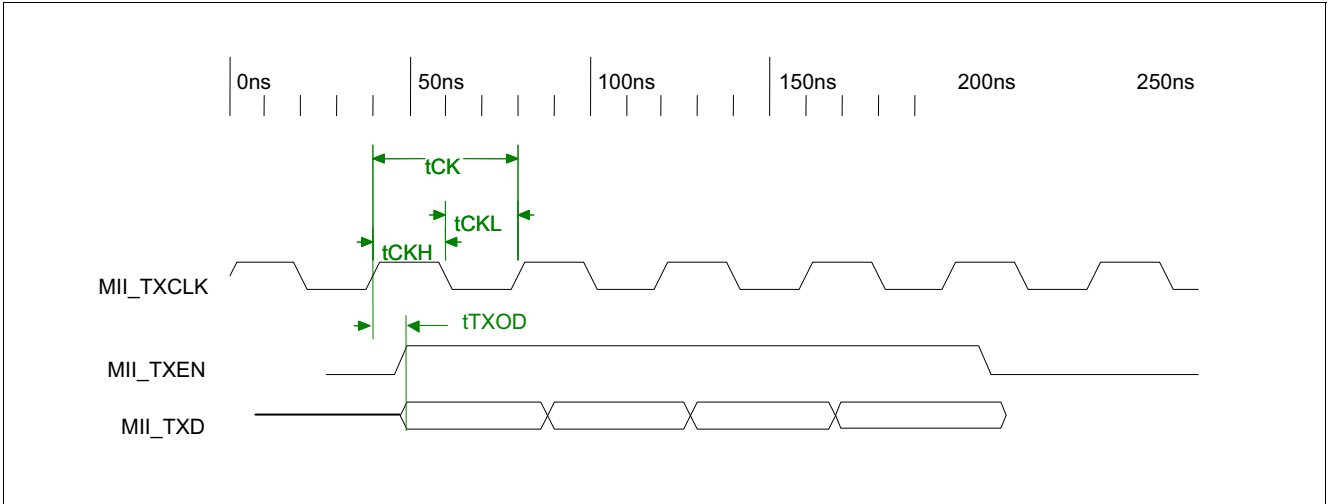

Figure 23 100Base-TX MII Output Timing

Table 68 100Base-TX MII Output Timing

Parameter	Symbol	Values			Unit	Note / Test Condition
		Min.	Typ.	Max.		
MII_TXCLK Period	t_{CK}	–	40	–	ns	–
MII_TXCLK Low Period	t_{CKL}	18	–	22	ns	–
MII_TXCLK High Period	t_{CKH}	18	–	22	ns	–
MII_TXD, MII_TXEN to MII_TXCLK Rising Output Delay	t_{TXOD}	0	–	25	ns	–

7.3.8 RMII REFCLK Input Timing

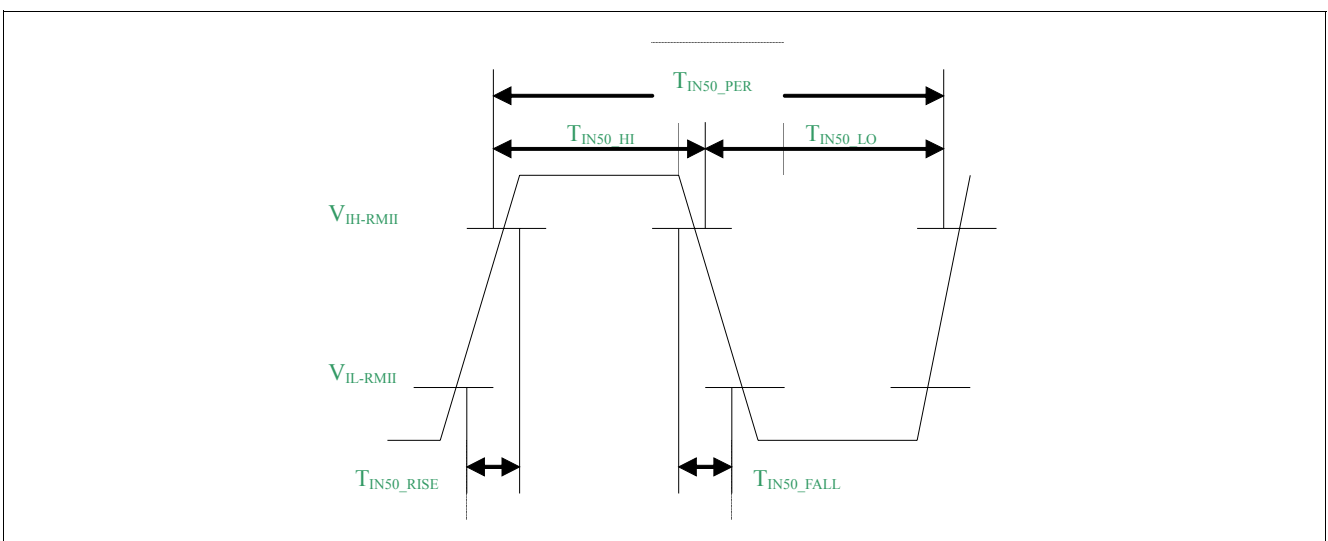

Figure 24 RMII REFCLK Input Timing

Table 69 RMI REFCLK Input Timing

Parameter	Symbol	Values			Unit	Note / Test Condition
		Min.	Typ.	Max.		
REFCLK Clock Period	t_{IN50_PER}	40.0 - 50ppm	40.0	40.0 + 50ppm	ns	–
REFCLK Clock High	t_{IN50_HI}	14	20.0	–	ns	–
REFCLK Clock Low	t_{IN50_LO}	14	20.0	–	ns	–
REFCLK Clock Rise Time, V_{IL} (max) to V_{IH} (min.)	t_{IN50_RISE}	–	–	2	ns	–
REFCLK Clock Fall Time, V_{IH} (min.) to V_{IL} (max)	t_{IN50_FALL}	–	–	2	ns	–

7.3.9 RMI REFCLK Output Timing

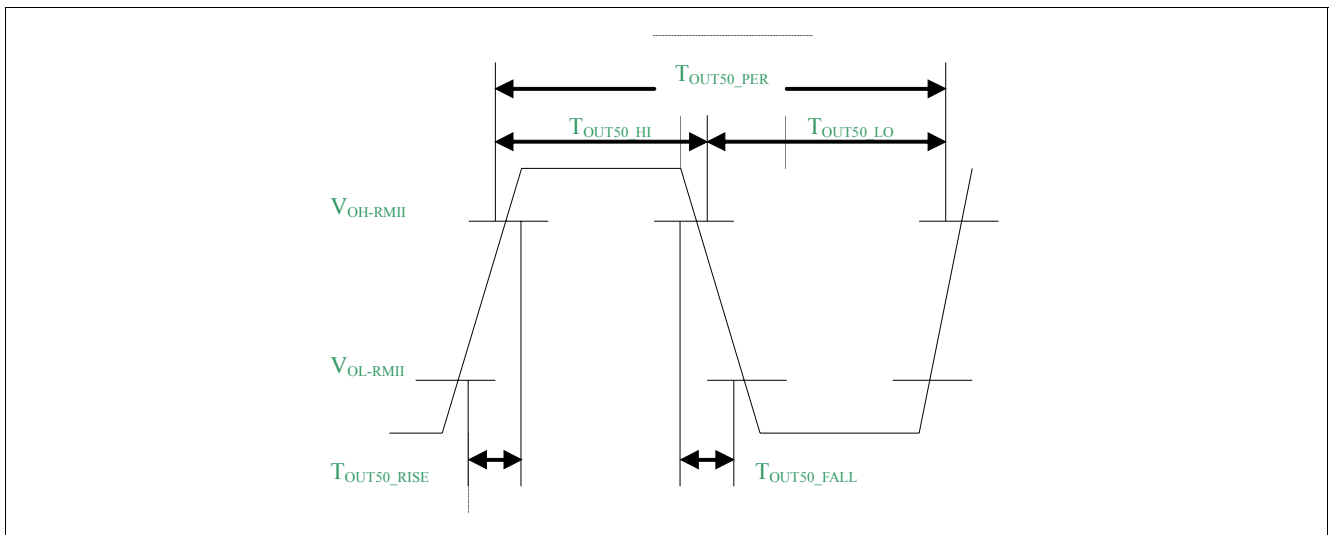

Figure 25 RMI REFCLK Output Timing

Table 70 RMI REFCLK Output Timing

Parameter	Symbol	Values			Unit	Note / Test Condition
		Min.	Typ.	Max.		
REFCLK Clock Period	t_{OUT50_PER}	40.0 - 50ppm	40.0	40.0 + 50ppm	ns	–
REFCLK Clock High	t_{OUT50_HI}	14	20.0	26	ns	–
REFCLK Clock Low	t_{OUT50_LO}	14	20.0	26	ns	–
REFCLK Clock Rise Time, V_{OL} (max) to V_{OH} (min.)	t_{OUT50_RISE}	–	–	2	ns	–
REFCLK Clock Fall Time, V_{OH} (min.) to V_{OL} (max)	t_{OUT50_FALL}	–	–	2	ns	–
REFCLK Clock Jittering (p-p)	t_{OUT50_JIT}	–	0.15	–	ns	–

7.3.10 Reduce MII Timing

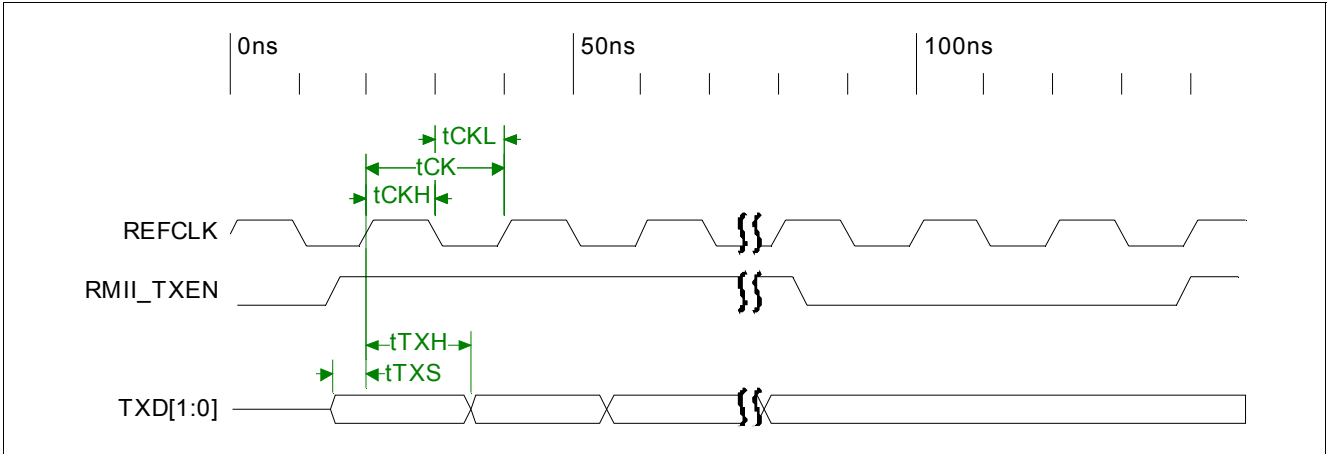

Figure 26 Reduce MII Timing (1 of 2)

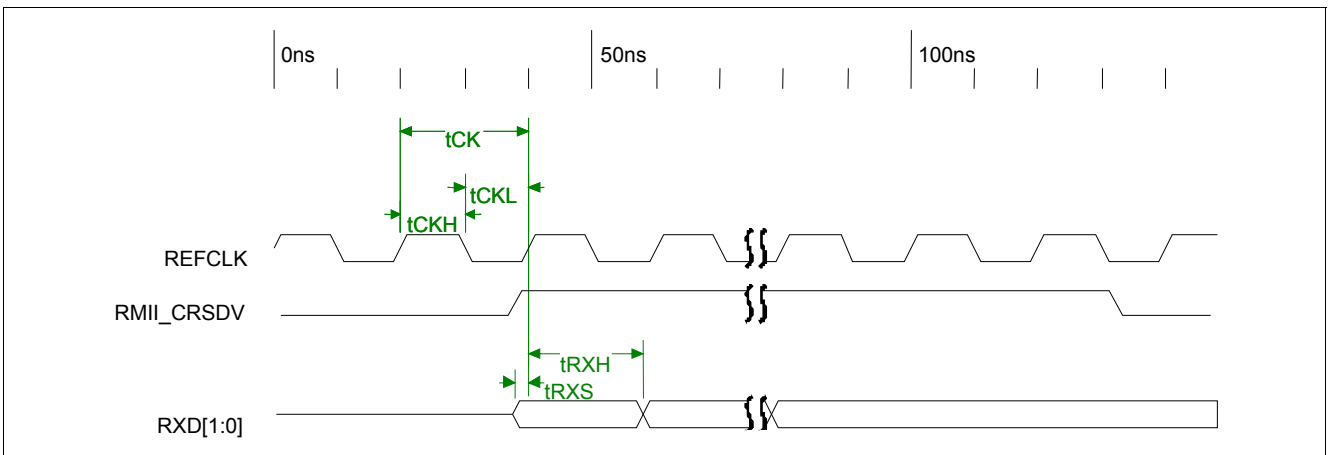

Figure 27 Reduce MII Timing (2 of 2)

Table 71 Reduce MII Timing

Parameter	Symbol	Values			Unit	Note / Test Condition
		Min.	Typ.	Max.		
RMII_REFCLK Period	t_{CK}	–	20	–	ns	–
RMII_REFCLK Low Period	t_{CKL}	–	10	–	ns	–
RMII_REFCLK High Period	t_{CKH}	–	10	–	ns	–
TXEN, TXD to REFCLK rising setup time	t_{TXS}	4	–	–	ns	–
TXE, TXD to REFCLK rising hold time	t_{TXH}	2	–	–	ns	–
CRSDV, RXD to REFCLK rising setup time	t_{RXS}	4	–	–	–	–
CRSDV, RXD to REFCLK rising hold time	t_{RXH}	2	–	–	–	–

7.3.11 GPSI (7-wire) Input Timing

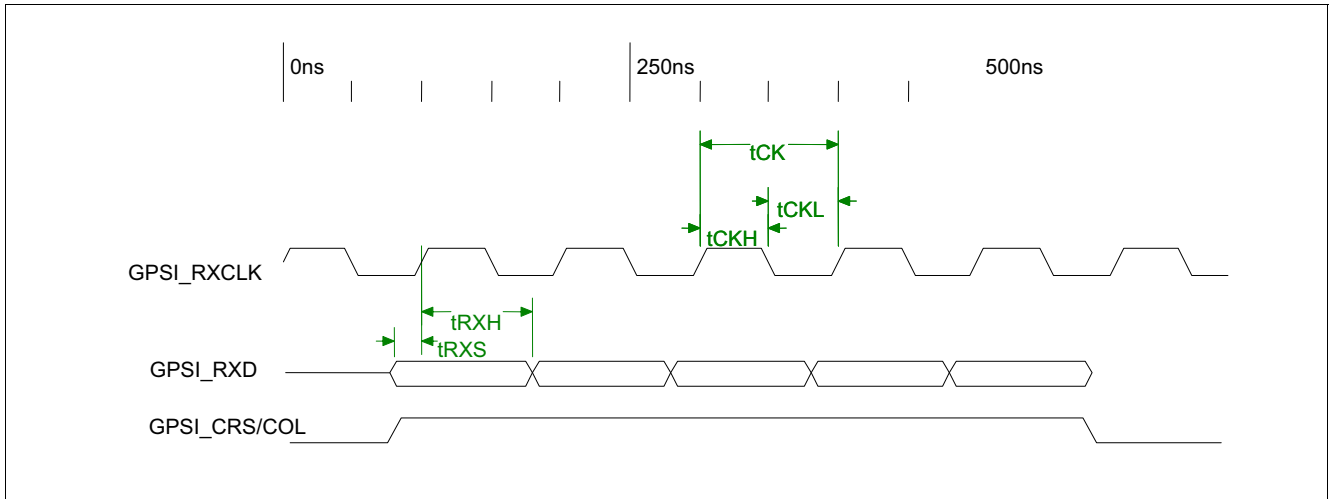

Figure 28 GPSI (7-wire) Input Timing

Table 72 GPSI (7-wire) Input Timing

Parameter	Symbol	Values			Unit	Note / Test Condition
		Min.	Typ.	Max.		
GPSI_RXCLK Period	t_{CK}	–	100	–	ns	–
GPSI_RXCLK Low Period	t_{CKL}	40	–	60	ns	–
GPSI_RXCLK High Period	t_{CKH}	40	–	60	ns	–
GPSI_RXD, GPSI_CRD/COL to GPSI_RXCLK Rising Setup Time	t_{RXS}	10	–	–	ns	–
GPSI_RXD, GPSI_CRD/COL to GPSI_RXCLK Rising HoldTime	t_{RXH}	10	–	–	ns	–

7.3.12 GPSI (7-wire) Output Timing

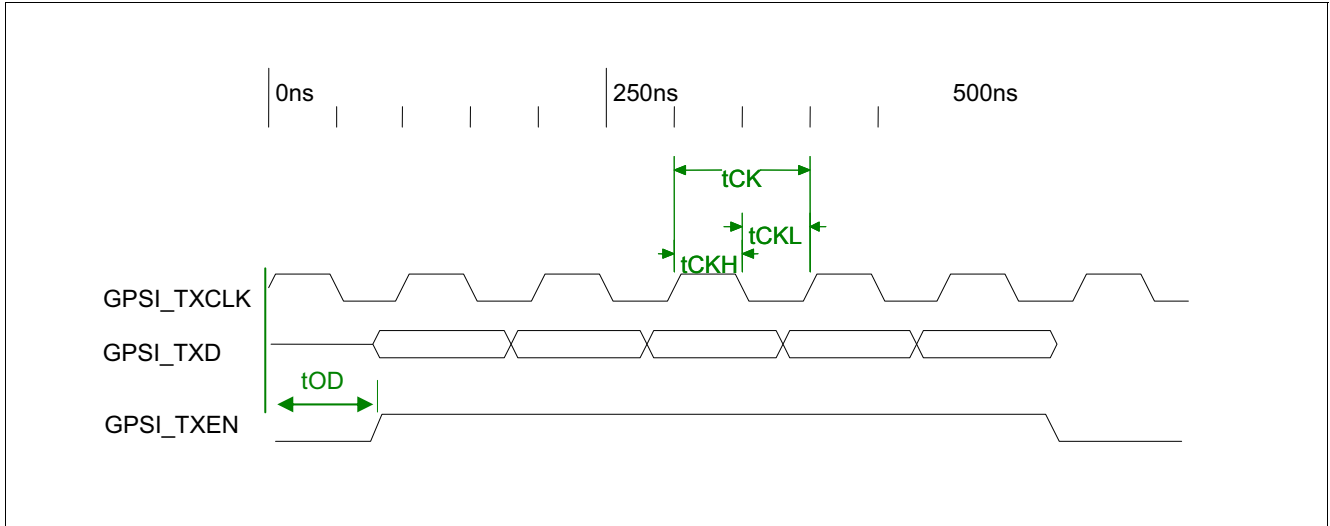

Figure 29 GPSI (7-wire) Output Timing

Table 73 GPSI (7-wire) Output Timing

Parameter	Symbol	Values			Unit	Note / Test Condition
		Min.	Typ.	Max.		
GPSI_TXCLK Period	t_{CK}	–	100	–	ns	–
GPSI_TXCLK Low Period	t_{CKL}	40	–	60	ns	–
GPSI_TXCLK High Period	t_{CKH}	40	–	60	ns	–
GPSI_TXCLK Rising to GPSI_TXEN/GPSI_TXD Output Delay	t_{OD}	50	–	70	ns	–

7.3.13 SDC/SDIO Timing

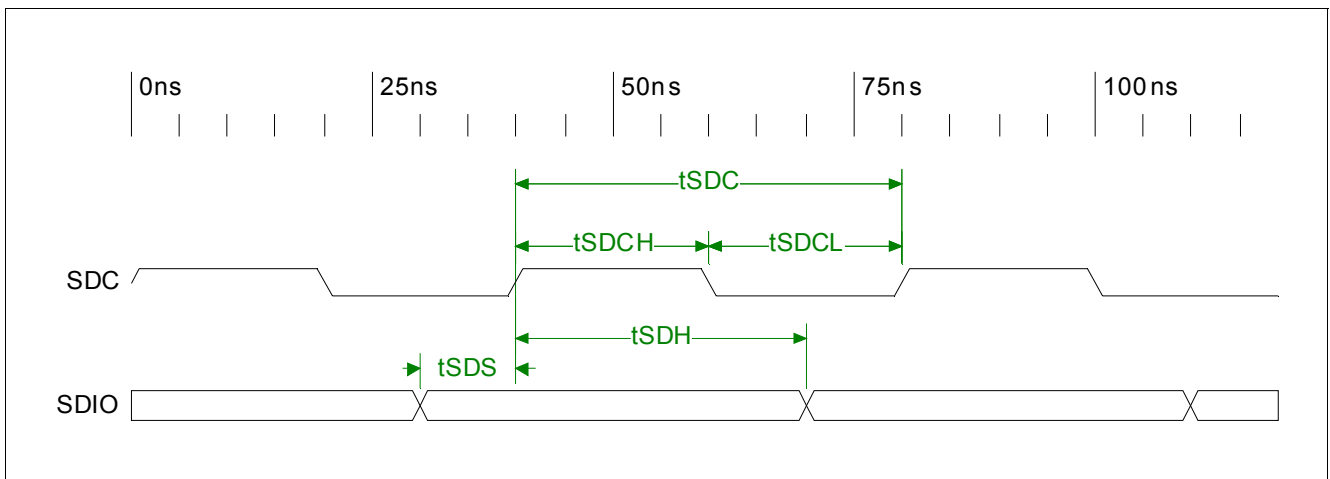

Figure 30 SDC/SDIO Timing

Table 74 SDC/SDIO Timing

Parameter	Symbol	Values			Unit	Note / Test Condition
		Min.	Typ.	Max.		
SDC Period	t_{CK}	20	–	–	ns	–
SDC Low Period	t_{CKL}	10	–	–	ns	–
SDC High Period	t_{CKH}	10	–	–	ns	–
SDIO to SDC rising setup time on read/write cycle	t_{SDS}	4	–	–	ns	–
SDIO to SDC rising hold time on read/write cycle	t_{SDH}	2	–	–	ns	–

8 Package Outlines

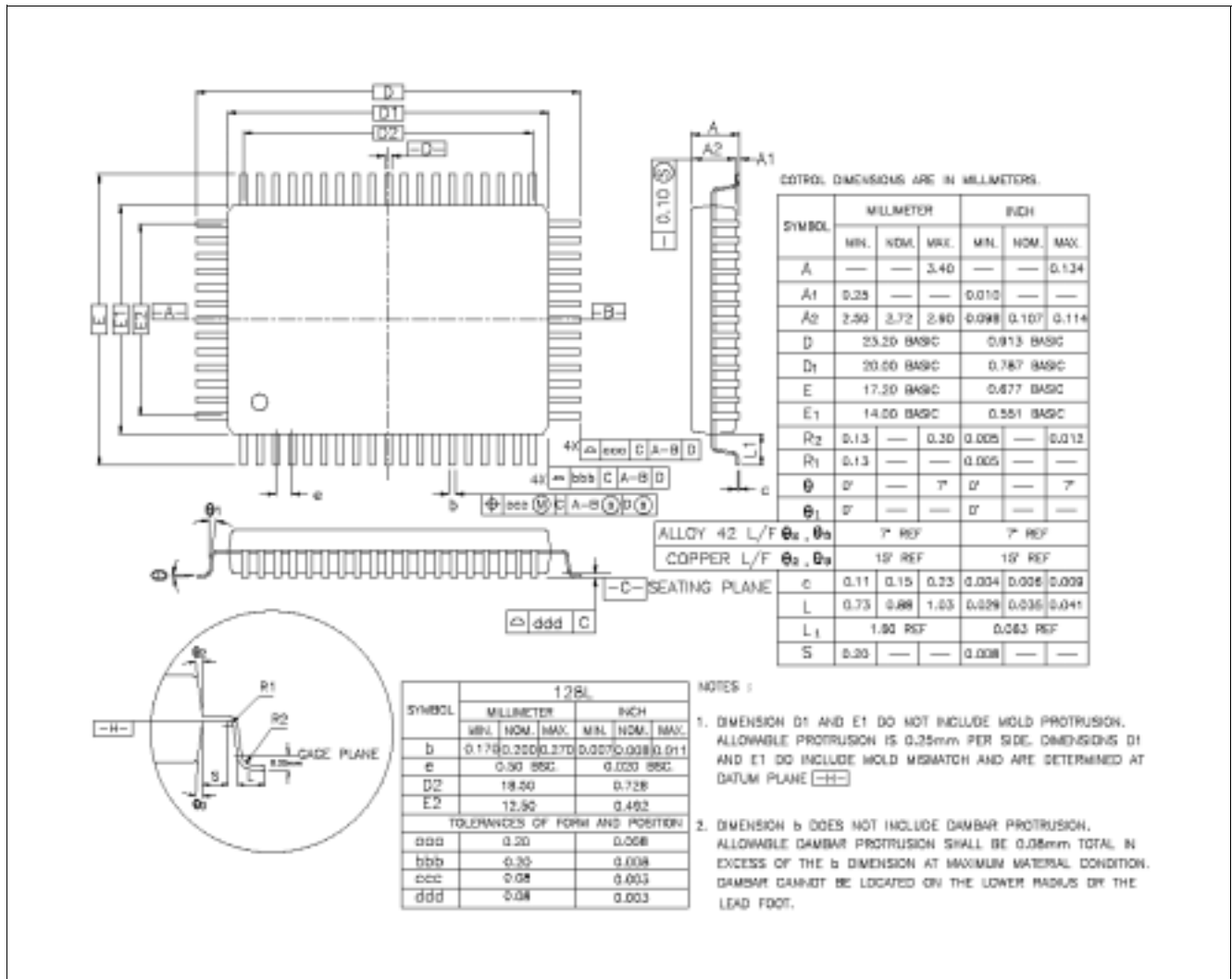

Figure 31 P-QFP-128 Outside Dimension

8.1 Package Information

Product Name	Product Type	Package
6-Port 10/100 Mbit/s Single Chip Ethernet Switch Controller	Samurai, ADM6996LC/LCX/LHX-AC-T-1), Version AC	P-QFP-128

Terminology

B

BER Bit Error Rate

C

CFI Canonical Format Indicator

COL Collision

CRC Cyclic Redundancy Check

CRS Carrier Sense

CS Chip Select

D

DA Destination Address

DI Data Input

DO Data Output

E

EDI EEPROM Data Input

EDO EEPROM Data Output

EECS EEPROM Chip Select

EESK EEPROM Clock

ESD End of Stream Delimiter

F

FEFI Far End Fault Indication

FET Field Effect Transistor

FLP Fast Link Pulse

G

GND Ground

GPSI General Purpose Serial Interface

I

IPG Inter-Packet Gap

L

LFSSR Linear Feedback Shift Register

M

MAC Media Access Controller

MDIX MDI Crossover

MII Media Independent Interface

N

NRZI Non Return to Zero Inverter

NRZ Non Return to Zero

P

PCS Physical Coding Sub-layer

PHY Physical Layer

PLL Phase Lock Loop

PMA Physical Medium Attachment

PMD	Physical Medium Dependent
Q	
QoS	Quality of Service
QFP	Quad Flat Package
R	
RST	Reset
RXCLK	Receive Clock
RXD	Receive Data
RXDV	Receive Data Valid
RXER	Receive Data Errors
RXN	Receive Negative (Analog receive differential signal)
RXP	Receive Positive (Analog receive differential signal)
S	
SA	Source Address
SOHO	Small Office Home Office
SSD	Start of Stream Delimiter
SQE	Signal Quality Error
T	
TOS	Type of Service
TP	Twisted Pair
TTL	Transistor Logic
TXCLK	Transmission Clock
TXD	Transmission Data
TXEN	Transmission Enable
TXN	Transmission Negative
TXP	Transmission Positive

www.infineon.com

Published by Infineon Technologies AG