

### FEATURES

- 128 position, digitally controlled potentiometer
- Operates from a +5 volts power supply with TTL signal inputs
- Wide analog voltage range of  $\pm 5$  volts
- Low-power CMOS
- 14-pin DIP or 16-pin SOIC for surface mount applications
- Default position on power up sets wiper position to 10% of active digital taps (3% of the total end-to-end resistance)
- Operating temperature range
  - Industrial temp. range:  $-40^{\circ}\text{C}$  to  $+85^{\circ}\text{C}$

| Resistance values | Resistance/Step |                |  | -3dB Point |
|-------------------|-----------------|----------------|--|------------|
|                   | Low End         | High End       |  |            |
| DS1666-10 10K     | 24 $\Omega$     | 152 $\Omega$   |  | 1.0 MHz    |
| DS1666-50 50K     | 122 $\Omega$    | 759 $\Omega$   |  | 200 kHz    |
| DS1666-100 100K   | 243 $\Omega$    | 1.519 $\Omega$ |  | 100 kHz    |

### PIN ASSIGNMENT

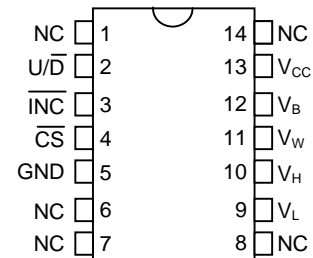

14-PIN DIP (300 MIL)  
See Mech. Drawings Section

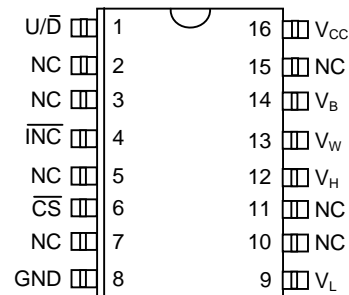

16-PIN SOIC (300 MIL)  
See Mech. Drawings Section

### PIN DESCRIPTIONS

- $V_H$  - High Terminal of Potentiometer
- $V_L$  - Low Terminal of Potentiometer
- $V_W$  - Wiper Terminal of Potentiometer
- $U/\bar{D}$  - Up/Down Control
- $\overline{INC}$  - Wiper Movement Control
- $\overline{CS}$  - Chip Select for Wiper Movement
- NC - No Connection
- $V_{CC}$  - 5V Power Supply Input
- GND - Ground
- $V_B$  - Substrate Bias Voltage (0 to -5V)

### DESCRIPTION

The DS1666 Audio Digital Resistor is a solid-state potentiometer composed of 127 digitally controlled resistive elements. Between each resistive section and both ends of the potentiometer are tap points multiplexed to the wiper. The position of the wiper on the resistance array is controlled by the  $\overline{CS}$ ,  $U/\bar{D}$  and  $\overline{INC}$  inputs. The taper of the DS1666 is shown in Figure 1.

The DS1666 is uniquely designed to provide a potentiometer that is pseudo-logarithmic rather than linear across its entire range. The lower half of the potentiometer advances 1% of total resistance for each 3% of scale advanced, providing for precise amplification of low volume signals. The upper half of the potentiometer advances 2% of resistance for every 1% of scale advanced, providing for the lower resolution gain required for high volume amplification.

## GRAPH OF AUDIO TAPER Figure 1

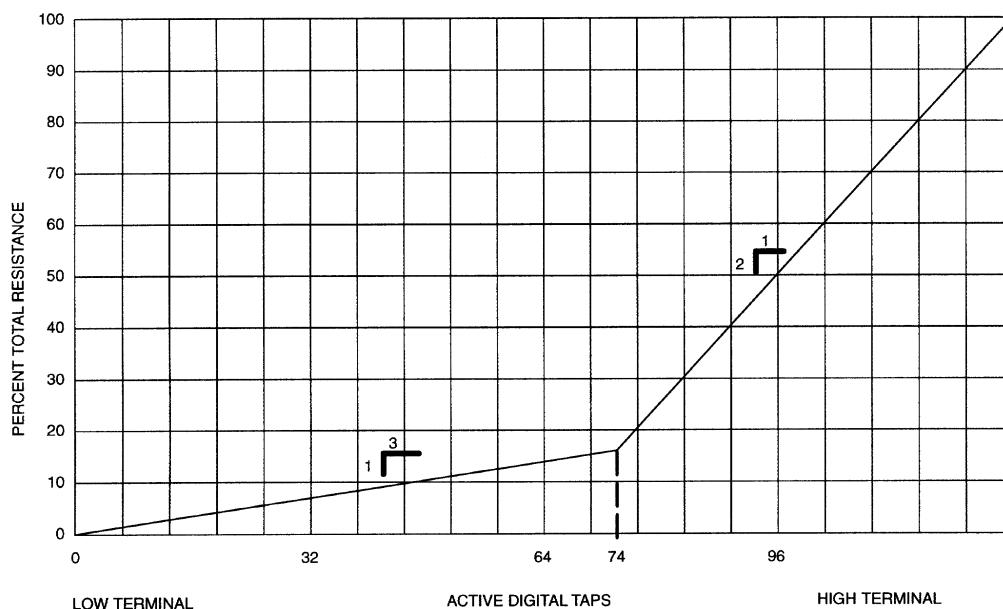

## OPERATION

The DS1666 has a total of 128 tap-points including the  $V_L$  and  $V_H$  terminals. A total of 127 resistive segments exist between the  $V_L$  and  $V_H$  terminals. These tap-points are accessible to the  $V_W$  terminal whose position is controlled via a 3-terminal control port. A block diagram of the DS1666 is shown in Figure 2.

The 3-terminal port of the DS1666 provides an increment/ decrement interface which is activated via a chip select input. This interface consists of the input signals  $\overline{CS}$ ,  $\overline{INC}$ , and  $U/\overline{D}$ . These input signals control a 7-bit up/down counter. The output of the 7-bit up/down counter controls a 1 of 128 decoder to select wiper position. The timing diagram for the 3-terminal interface control is shown in Figure 4.

## ANALOG CHARACTERISTICS

The DS1666 has a pseudo-logarithmic resistor array that resembles an audio taper potentiometer as shown in Figure 1. Taps on the lower portion of the potentiometer increment 0.25% of the total resistance and are specified to within  $\pm 0.5\%$  of the expected value. Taps on the higher portion increment 1.5% of the total resistance and are specified to within  $\pm 2.0\%$  of the expected value.

End-to-End Resistance Tolerance =  $\pm 20\%$

Temperature Coefficient = 750 PPM/ $^{\circ}\text{C}$  typical

## PIN DESCRIPTIONS

**V<sub>CC</sub>** - Power Supply. The DS1666 will support supply voltages ranging from +4.5 to +5.5 volts.

**GND** - Ground Terminal.

**V<sub>B</sub>** - Negative Bias. The DS1666 will support a negative bias ranging from 0 to -5 volts.

**H** - High-Terminal of Potentiometer. It is not required that this terminal be connected to a potential greater than the V<sub>L</sub> terminal. Voltage applied to the V<sub>H</sub> terminal can not exceed the power-supply voltage, (V<sub>CC</sub>), or go below the negative bias, (V<sub>B</sub>).

**V<sub>L</sub>** - Low-Terminal of Potentiometer. It is not required that this terminal be connected to a potential less than the V<sub>H</sub> terminal. Voltage applied to the V<sub>L</sub> terminal cannot exceed the power-supply voltage, (V<sub>CC</sub>), or go below the negative bias (V<sub>B</sub>).



**V<sub>w</sub>** - Wiper of the Potentiometer. Its position on the resistor array is controlled by the 3-terminal control port. Voltage applied to the wiper cannot exceed the power-supply voltage, V<sub>CC</sub>, or go below the negative bias (V<sub>B</sub>).

**$\overline{\text{CS}}$**  - Chip Select. The  $\overline{\text{CS}}$  input is used to activate the control port of the DS1666. This input is active low. When in a high-state, activity on the  $\overline{\text{INC}}$  and U/ $\overline{\text{D}}$  port pins will not affect or change wiper position.

**$\overline{\text{INC}}$**  - Wiper Movement Control. This input provides for wiper position changes when the  $\overline{\text{CS}}$  pin is low. Wiper position changes will occur one position per high-to-low transition of this input signal. Position changes will not occur if the  $\overline{\text{CS}}$  pin is in a high-state.

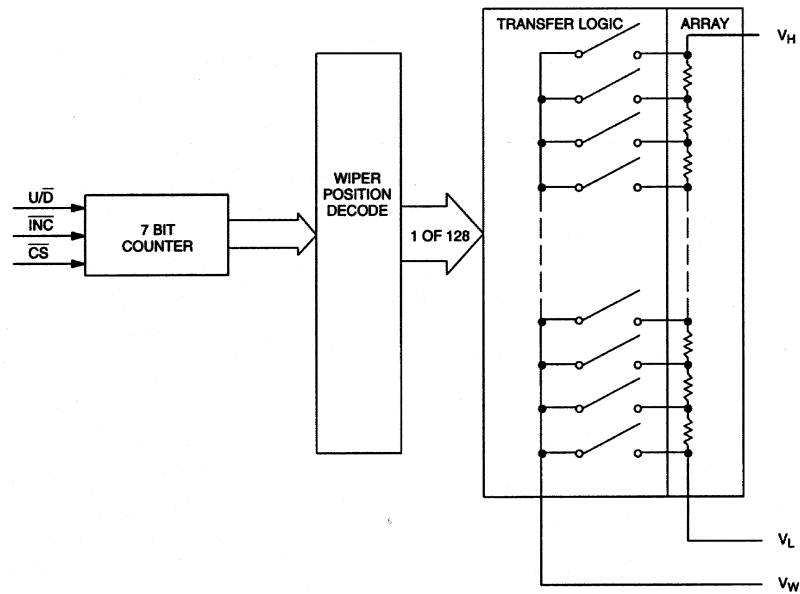
**U/ $\overline{\text{D}}$**  - Up/Down Control. This input sets the direction of wiper movement. When in a high-state and  $\overline{\text{CS}}$  is low, any high-to-low transition on  $\overline{\text{INC}}$  will cause a one position movement of the wiper towards the V<sub>H</sub> terminal. When in a low-state and  $\overline{\text{CS}}$  is low, any high-to-low transitions on  $\overline{\text{INC}}$  will cause the position of the wiper to move towards the V<sub>L</sub> terminal.

**BLOCK DIAGRAM** Figure 2**MODE SELECTION** Figure 3

| $\overline{CS}$ | $\overline{INC}$  | $\overline{U/D}$ | MODE       |
|-----------------|---|------------------|------------|
| L               |  | H                | WIPER UP   |
| L               |  | L                | WIPER DOWN |
| H               | X   | X                | INACTIVE   |

**ABSOLUTE MAXIMUM RATINGS\***

|   |                      |
|---|----------------------|
| Voltage on $\overline{CS}$ , $\overline{INC}$ , $U/\overline{D}$ and $U/\overline{D}$ and $V_{CC}$ Relative to Ground | -0.5V to +7.0V       |
| Voltage on $V_H$ , $V_L$ and $V_W$ Relative to Ground   | -6.5V to +6.5V       |
| Voltage on $V_B$  | -6.5V to GND         |
| Operating Temperature   | -40° to +85°C        |
| Storage Temperature   | -55°C to +125°C      |
| Soldering Temperature   | 260°C for 10 seconds |

\* This is a stress rating only and functional operation of the device at these or any other conditions above those indicated in the operation sections of this specification is not implied. Exposure to absolute maximum rating conditions for extended periods of time may affect reliability.

**RECOMMENDED DC OPERATING CONDITIONS** (-40°C to +85°C)

| PARAMETER                     | SYMBOL   | MIN       | TYP | MAX          | UNITS | NOTES |
|-------------------------------|----------|-----------|-----|--------------|-------|-------|
| Supply Voltage                | $V_{CC}$ | +4.5      | 5.0 | 5.5          | V     | 1     |
| Input Logic 1                 | $V_{IH}$ | 2.0       |     | $V_{CC}+0.5$ | V     | 1     |
| Input Logic 0                 | $V_{IL}$ | -0.5      |     | +0.8         | V     | 1     |
| $V_H$ , $V_L$ , $V_W$ Voltage | $V_R$    | $V_B-0.3$ |     | $V_{CC}+0.3$ | V     | 1, 3  |
| $V_B$ Voltage                 | $V_B$    | -5.5      |     | GND          | V     | 1     |

**DC ELECTRICAL CHARACTERISTICS** (-40°C to +85°C;  $V_{CC} = 5.0V \pm 10\%$ )

| PARAMETER        | SYMBOL   | MIN | TYP | MAX | UNITS    | NOTES |
|------------------|----------|-----|-----|-----|----------|-------|
| Supply Current   | $I_{CC}$ |     | 0.2 | 4.5 | mA       | 4     |
| Input Leakage    | $I_{LI}$ | -1  |     | +1  | $\mu A$  |       |
| Wiper Resistance | $R_W$    |     | 350 | 900 | $\Omega$ | 2     |
| Wiper Current    | $I_W$    |     |     | 1   | mA       |       |

**CAPACITANCE** ( $t_A=25^\circ C$ )

| PARAMETER   | SYMBOL   | CONDITION        | TYP | MAX | UNITS | NOTES |
|-------------|----------|------------------|-----|-----|-------|-------|
| Capacitance | $C_{IN}$ | $t_A=25^\circ C$ | 6   |     | pF    |       |

**ANALOG RESISTOR CHARACTERISTICS** (-40°C to +85°C;  $V_{CC} = 5.0V \pm 10\%$ )

| PARAMETER                     | SYMBOL       | MIN  | TYP | MAX  | UNITS      | NOTES |
|-------------------------------|--------------|------|-----|------|------------|-------|
| Total Resistance              |              |      |     |      |            |       |
| “-10”                         |              |      | 10  |      | K $\Omega$ | 5     |
| “-50”                         |              |      | 50  |      | K $\Omega$ | 5     |
| “-100”                        |              |      | 100 |      | K $\Omega$ | 5     |
| End-to-End Resistor Tolerance |              | -20  |     | +20  | %          | 8     |
| Absolute Tolerance            |              |      |     |      |            |       |
| Low End (0.25% Increments)    |              | -0.5 |     | +0.5 | %          | 6     |
| High End (1.5% Increments)    |              | -2.0 |     | +2.0 | %          | 6     |
| -3 dB Cutoff Frequency        | $f_{CUTOFF}$ |      |     |      | MHz        | 7     |
| Temperature Coefficient       |              |      | 750 |      | ppm/°C     |       |

**AC ELECTRICAL CHARACTERISTICS** (-40°C to +85°C;  $V_{CC} = 5.0V \pm 10\%$ )

| PARAMETER   | SYMBOL   | MIN | TYP | MAX | UNITS   | NOTES |
|---|----------|-----|-----|-----|---------|-------|
| $\overline{CS}$ to $\overline{INC}$ Setup         | $t_{CI}$ | 100 |     |     | ns      |       |
| $\overline{INC}$ High to U/ $\overline{D}$ Change | $t_{ID}$ | 100 |     |     | ns      |       |
| U/ $\overline{D}$ to $\overline{INC}$ Setup       | $t_{DI}$ | 1   |     |     | $\mu$ s |       |
| $\overline{INC}$ Low Period                       | $t_{IL}$ | 500 |     |     | ns      |       |
| $\overline{INC}$ High Period                      | $t_{IH}$ | 1   |     |     | $\mu$ s |       |
| $\overline{INC}$ Low to Wiper Change              | $t_{IW}$ |     |     | 200 | ns      |       |

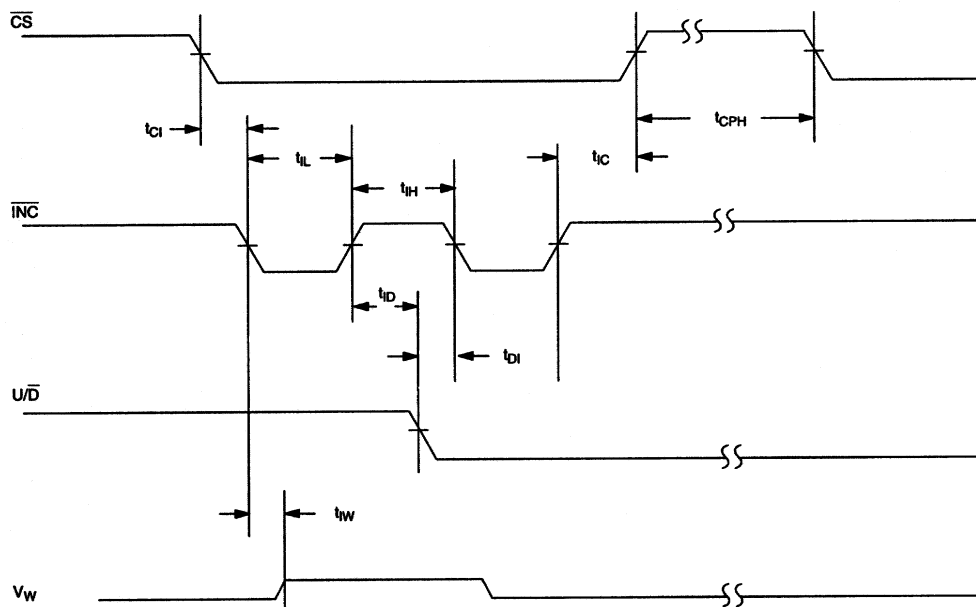
**AC TIMING** Figure 4**NOTES:**

1. All Voltages are referenced to ground.
2. Typical Values are for  $T_A=25^\circ\text{C}$  and nominal supply voltages.
3. Resistors input voltages cannot go below  $V_B$  or exceed  $V_{CC}$  by the amounts shown.
4. Maximum current specifications are based on the clock rate of  $\overline{\text{INC}}$  input. This specification represents the current required when changing the wiper position.
5. The DS1666 is available in three end-to-end resistor values. These include  $10\text{K}\Omega$  for the DS1666-10;  $50\text{K}\Omega$  for the DS1666-50; and  $100\text{K}\Omega$  for the DS1666-100.
6. Absolute tolerance is used to compare measured wiper voltage versus expected wiper voltage as determined by wiper position.
7. -3dB cutoff frequency characteristics for the DS1666 depend on potentiometer total resistance. The DS1666-10 is 1 MHz; the DS1666-50 is 200 KHz; and the DS1666-100 is 100 KHz.
8. Valid at  $25^\circ\text{C}$  only

**AC TEST CONDITIONS**

Input Pulse Levels            0V to 3V  
 Input Rise and Fall Times    10 ns

**DS1666 ORDERING INFORMATION**

| <b>ORDERING NUMBER</b> | <b>PACKAGE</b>     | <b>OPERATING TEMPERATURE</b> | <b>VERSION</b> |
|------------------------|--------------------|------------------------------|----------------|
| DS1666-010             | 14L DIP            | -40°C TO +85°C               | 10 kΩ          |
| DS1666-050             | 14L DIP            | -40°C TO +85°C               | 50 kΩ          |
| DS1666-100             | 14L DIP            | -40°C TO +85°C               | 100 kΩ         |
| DS1666S-010*           | 16L SOIC (300-mil) | -40°C TO +85°C               | 10 kΩ          |
| DS1666S-050*           | 16L SOIC (300-mil) | -40°C TO +85°C               | 50 kΩ          |
| DS1666S-100*           | 16L SOIC (300-mil) | -40°C TO +85°C               | 100 kΩ         |

\* Add "/T & R" for tape and reel packaging.



---

## **DATA SHEET REVISION SUMMARY**

The following represent the key differences between 07/26/93 and 06/18/97 version of the DS1666 data sheet. Please review this summary carefully.

1. Remove commercial temp grade reference.
2. Add order info table.
3. Improve operating description and add “ANALOG Resistor CHARACTERISTICS”.