

# TLV5621E LOW-POWER QUADRUPLE 8-BIT DIGITAL-TO-ANALOG CONVERTER

SLAS138 – APRIL 1996

- 2.7-V to 5.5-V Single-Supply Operation
- Three 8-Bit Voltage Output DACs
- One-Half Power 8-Bit Voltage Output DAC
- Fast Serial Interface . . . 1 MHz Max
- Simple Two-Wire Interface In Single Buffered Mode
- High-Impedance Reference Inputs For Each DAC
- Programmable for 1 or 2 Times Output Range
- Simultaneous-Update Facility In Double-Buffered Mode
- Internal Power-On Reset
- Low Power Consumption
- Half-Buffered Output
- Power-Down Mode

## applications

- Programmable Voltage Sources
- Digitally-Controlled Amplifiers/Attenuators
- Cordless/Wireless Communications
- Automatic Test Equipment
- Portable Test Equipment
- Process Monitoring and Control
- Signal Synthesis

D OR N PACKAGE  
(TOP VIEW)

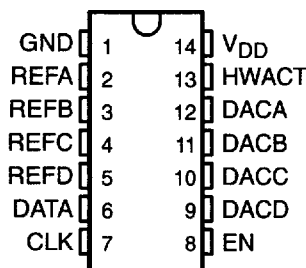

## description

The TLV5621E is a quadruple 8-bit voltage output digital-to-analog converter (DAC) with buffered reference inputs (high impedance). The DAC produces an output voltage that ranges between either one or two times the reference voltages and GND, and the DAC is monotonic. The device is simple to use since it operates from a single supply of 2.7 V to 5.5 V. A power-on reset function is incorporated to provide repeatable start-up conditions. A global hardware shut-down terminal and the capability to shut down each individual DAC with software are provided to minimize power consumption.

Digital control of the TLV5621E is over a simple 3-wire serial bus that is CMOS compatible and easily interfaced to all popular microprocessor and microcontroller devices. A TLV5621E 11-bit command word consists of eight bits of data, two DAC select bits, and a range bit for selection between the times one or times two output range. The TLV5621E digital inputs feature Schmitt triggers for high noise immunity. The DAC registers are double buffered which allows a complete set of new values to be written to the device, and then under control of the HWACT signal, all of the DAC outputs are updated simultaneously.

The 14-terminal small-outline (D) package allows digital control of analog functions in space-critical applications. The TLV5621E does not require external trimming. The TLV5621E is characterized for operation from -25°C to 85°C.



Please be aware that an important notice concerning availability, standard warranty, and use in critical applications of Texas Instruments semiconductor products and disclaimers thereto appears at the end of this data sheet.

PRODUCTION DATA information is current as of publication date. Products conform to specifications per the terms of Texas Instruments standard warranty. Production processing does not necessarily include testing of all parameters.

 **TEXAS  
INSTRUMENTS**

POST OFFICE BOX 655303 • DALLAS, TEXAS 75265

Copyright © 1996, Texas Instruments Incorporated

# TLV5621E LOW-POWER QUADRUPLE 8-BIT DIGITAL-TO-ANALOG CONVERTER

SLAS138 – APRIL 1996

## AVAILABLE OPTIONS

PACKAGE		
T <sub>A</sub>	SMALL OUTLINE (D)	PLASTIC DIP (N)
-20°C to 85°C	TLV5621ED	TLV5621EN

## functional block diagram

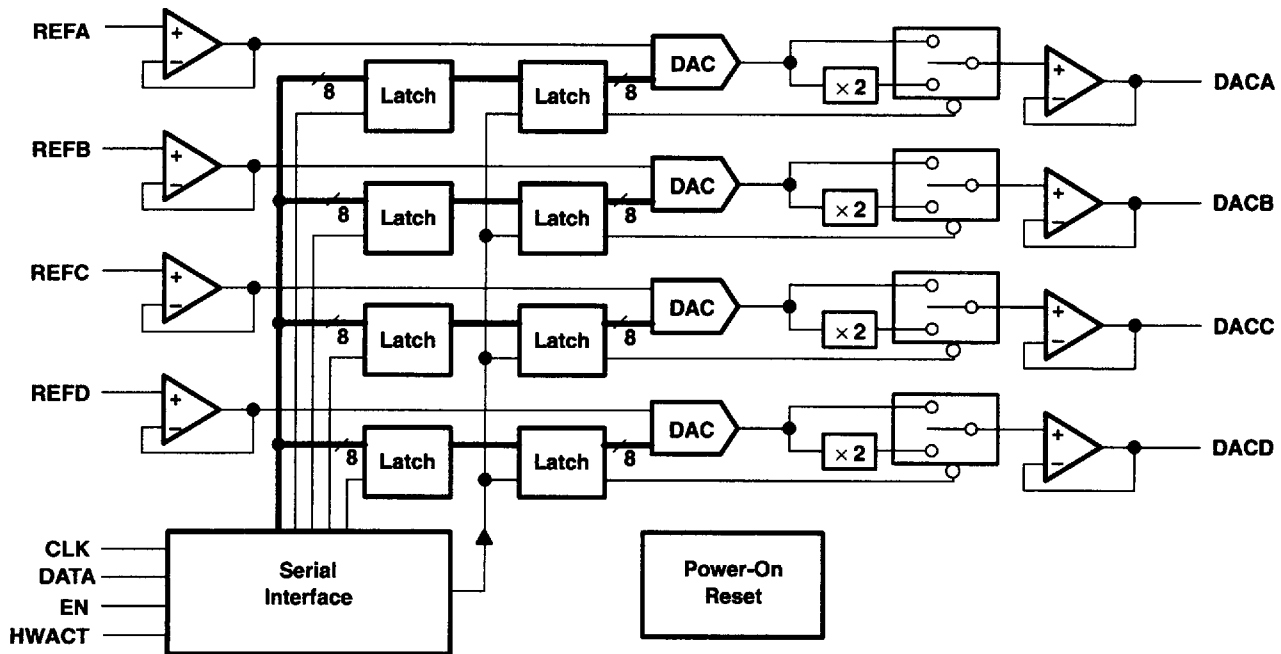

## Terminal Functions

TERMINAL NAME	NO.	I/O	DESCRIPTION
CLK	7	I	Serial-interface clock, data enters on the negative edge
DACA	12	O	DAC A analog output
DACB	11	O	DAC B analog output
DACC	10	O	DAC C analog output
DACD	9	O	DAC D analog output
DATA	6	I	Serial-interface digital-data input
EN	8	I	Input enable
GND	1		Ground return and reference
HWACT	13	I	Global hardware activate
REFA	2	I	Reference voltage input to DACA
REFB	3	I	Reference voltage input to DACB
REFC	4	I	Reference voltage input to DACC
REFD	5	I	Reference voltage input to DACD
V <sub>DD</sub>	14		Positive supply voltage

# TLV5621E

## LOW-POWER QUADRUPLE 8-BIT DIGITAL-TO-ANALOG CONVERTER

SLAS138 – APRIL 1996

### detailed description

The TLV5621 is implemented using four resistor-string DACs. The core of each DAC is a single resistor with 256 taps, corresponding to the 256 possible codes listed in Table 1. One end of each resistor string is connected to GND and the other end is fed from the output of the reference input buffer. Monotonicity is maintained by use of the resistor strings. Linearity depends upon the matching of the resistor elements and upon the performance of the output buffer. Because the inputs are buffered, the DACs always present a high-impedance load to the reference source.

Each DAC output is buffered by a configurable-gain output amplifier, which can be programmed to times one or times two gain.

On power-up, the DACs are reset to CODE 0.

Each output voltage is given by:

$$V_O(\text{DACAIBICID}) = \text{REF} \times \frac{\text{CODE}}{256} \times (1 + \text{RNG bit value})$$

where CODE is in the range 0 to 255 and the range (RNG) bit is a 0 or 1 within the serial control word.

**Table 1. Ideal-Output Transfer**

D7	D6	D5	D4	D3	D2	D1	D0	OUTPUT VOLTAGE
0	0	0	0	0	0	0	0	GND
0	0	0	0	0	0	0	1	$(1/256) \times \text{REF} (1+\text{RNG})$
•	•	•	•	•	•	•	•	•
•	•	•	•	•	•	•	•	•
0	1	1	1	1	1	1	1	$(127/256) \times \text{REF} (1+\text{RNG})$
1	0	0	0	0	0	0	0	$(128/256) \times \text{REF} (1+\text{RNG})$
•	•	•	•	•	•	•	•	•
•	•	•	•	•	•	•	•	•
1	1	1	1	1	1	1	1	$(255/256) \times \text{REF} (1+\text{RNG})$

### data interface

The data interface has two modes of operation; single and double buffered. Both modes serially clock in bits of data using DATA and CLK whenever EN is high. When EN is low, CLK is disabled and data cannot be loaded into the buffers.

In the single buffered mode, the DAC outputs are updated on the last/twelfth falling edge of CLK, so this mode only requires a two-wire interface with EN tied high (see Figure 1 and Figure 2).

In the double buffered mode (startup default), the outputs of the DACs are updated on the falling edge of the EN strobe (see Figure 3 and Figure 4). This allows multiple devices to share data and clock lines by having only separate EN lines.



POST OFFICE BOX 655303 • DALLAS, TEXAS 75265

# TLV5621E

## LOW-POWER QUADRUPLE 8-BIT DIGITAL-TO-ANALOG CONVERTER

SLAS138 – APRIL 1996

---

### single-buffer mode (MODE = 1)

When a two wire interface is used, EN is tied high and the input to the device is always active; therefore, random data can be clocked into the input latch. In order to regain word synchronization, twelve zeros are clocked in as shown in Figure 1, and then a data or control word is clocked in. In Figure 1, the MODE bit is set to one, and a control word is clocked in with the DAC outputs becoming active after the last falling edge of the control word.

Figure 2 shows valid data being written to a DAC, note that CLK is held low while the data is invalid. Data can be written to all four DACs and then the control word is clocked in which sets the MODE bit to 1. At the end of the control word, the data is latched to the inputs of the DACs.

Note that once the MODE bit has been set, it is not possible to clear it, i.e., it is not possible to move from single to double-buffered mode.



POST OFFICE BOX 655303 • DALLAS, TEXAS 75265

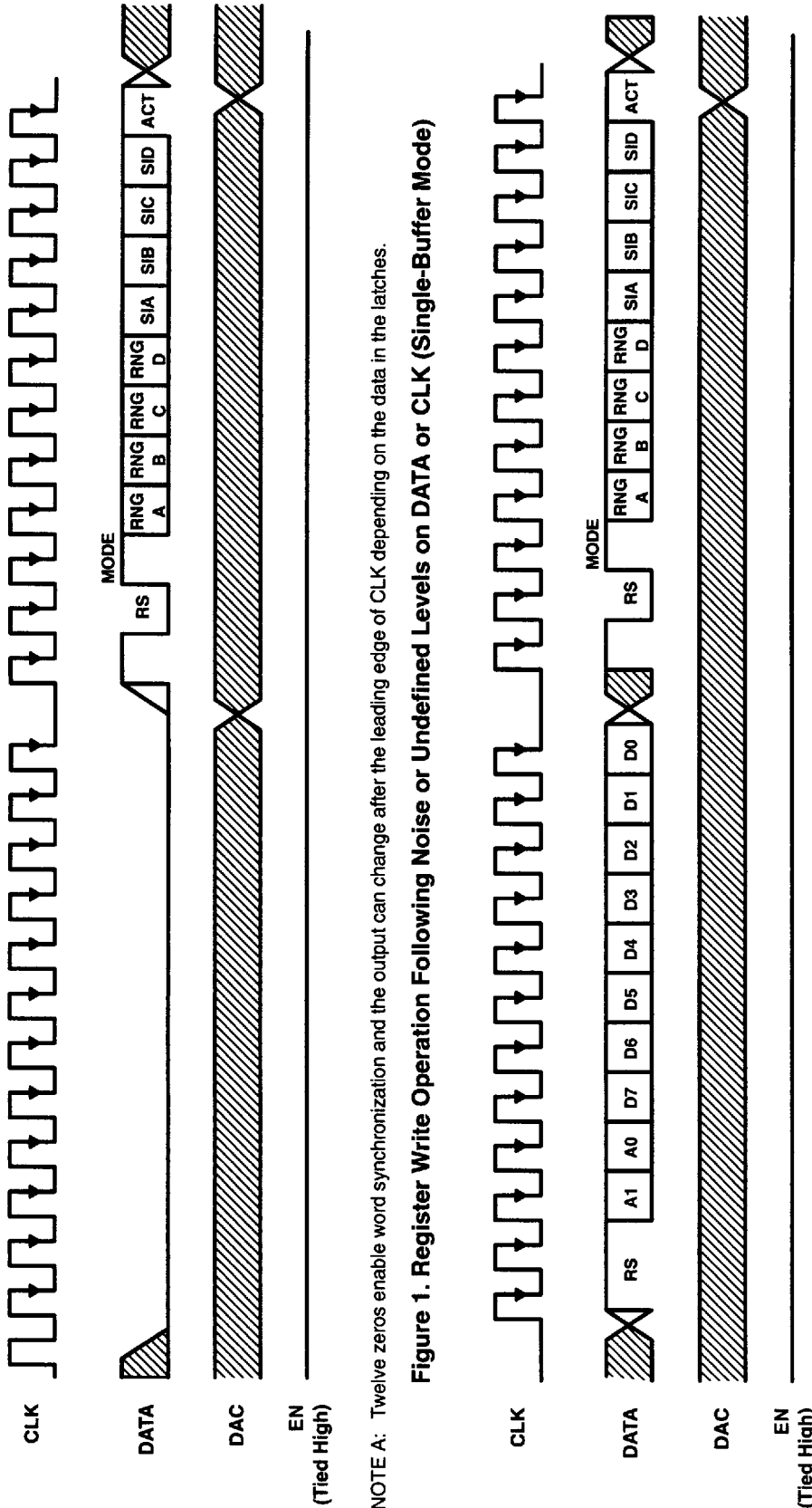

# TLV5621E LOW-POWER QUADRUPLE 8-BIT DIGITAL-TO-ANALOG CONVERTER

SLAS138 – APRIL 1996

## double-buffered mode (MODE = 0)

In this mode, data is only latched to the output of the DACs on the falling edge of the EN strobe. Therefore, all four DACs can be written to before updating their outputs.

Any number of input data blocks can be written with all having the same length. Subsequent data blocks simply overwrite previous ones with the same address until EN goes low.

Multiple data blocks can be written in any sequence provided signal timing limits are met. The negative going edge of EN terminates and latches all data.

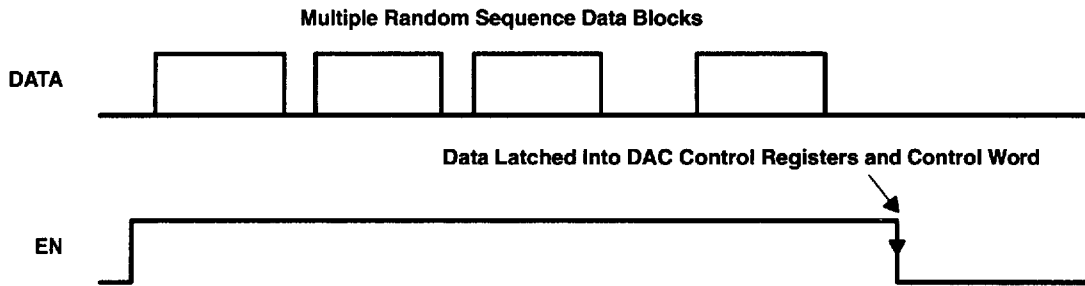
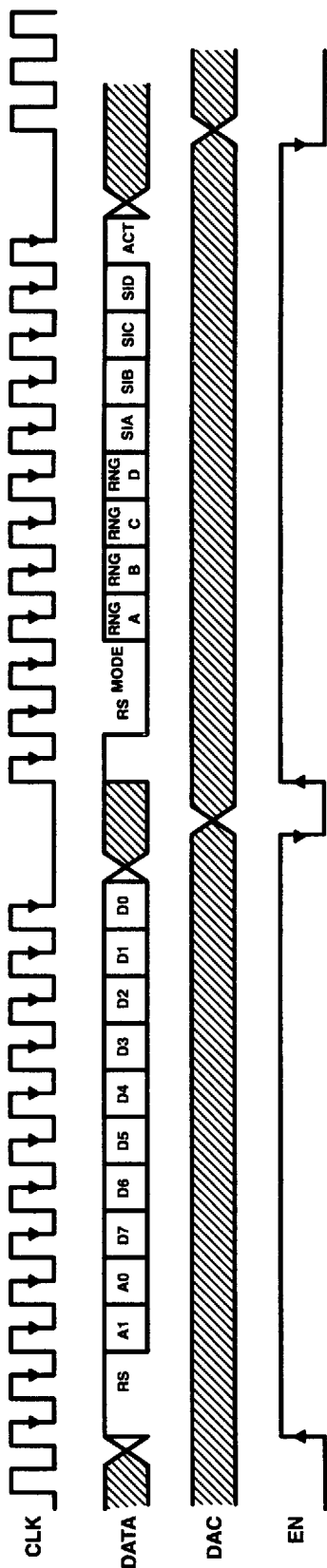

Figure 3. Data and Control Serial Control



NOTE A: Data is written to the output of a DAC, and the data is latched to the output on the falling edge of EN. A control word then selects double-buffered mode. When the range is changed, the output changes on the falling edge of EN.

Figure 4. First Nonzero Write Operation After Startup

# TLV5621E LOW-POWER QUADRUPLE 8-BIT DIGITAL-TO-ANALOG CONVERTER

SLAS138 – APRIL 1996

## control register

The control register contains ten active bits. Four bits are range select bits as on the TLC5620. The register also contains a software shutdown bit (ACT) and four shutdown inhibit bits (SIA, SIB, SIC, SID). The shutdown inhibit bits act on each DAC (DACA through DACD). The mode select bit is used to change between single and double buffered modes. The bits in the control register are listed in Table 2.

**Table 2. Control Register Bits**

BIT	FUNCTION
MODE	Selection bit for type of interface (see data interface section)
RNG A	Range select bit for DACA, 0 = $\times 1$ , 1 = $\times 2$
RNG B	Range select bit for DACB, 0 = $\times 1$ , 1 = $\times 2$
RNG C	Range select bit for DACC, 0 = $\times 1$ , 1 = $\times 2$
RNG D	Range select bit for DACD, 0 = $\times 1$ , 1 = $\times 2$
SIA	Shutdown inhibit bit for DACA
SIB	Shutdown inhibit bit for DACB
SIC	Shutdown inhibit bit for DACC
SID	Shutdown inhibit bit for DACD
ACT	Software shutdown bit

The Six bits inhibit the actions of the shutdown bits as shown in Table 3. When the ACT bit is 1 or the HWACT signal is high (active), the inhibit bits act as enable bits in inverse logic terms. The ACT software shutdown bit and HWACT (asynchronously acting hardware terminal) are logically ORed together.

This configuration allows any combination of DACs to be shut down to save power.

**Table 3. Shutdown Inhibit Bits and HWACT Signal**

Six	ACT	HWACT	DACx STATUS
0	0	L	Shutdown (see Note 1)
0	0	H	Shutdown
0	1	L	Shutdown
0	1	H	Active (see Note 1)
1	0	L	Active
1	0	H	Active
1	1	L	Active
1	1	H	Active

NOTE 1: Sense of HWACT terminal and ACT bit were changed from early versions of this specification.

The values of the input address select bits, A0 and A1, and the updated DAC are listed in Table 4.

**Table 4. Serial Input Decode**

INPUT ADDRESS SELECT BITS		DAC UPDATED
A1	A0	
0	0	DACA
0	1	DACB
1	0	DACC
1	1	DACD



# TLV5621E LOW-POWER QUADRUPLE 8-BIT DIGITAL-TO-ANALOG CONVERTER

SLAS138 – APRIL 1996

## power-on reset

Power-on reset circuitry is available on the TLV5621E. The threshold to trigger a power-on reset is 1.95 V typical (1.4 V min and 2.5 V max). For a power-on reset, all DACs are shut down. The control register bit values and states after a power-on reset are listed in Table 5.

**Table 5. Control Register Bit Values and States After Power-On Reset**

BIT	VALUE	STATE AFTER POWER-ON RESET
MODE	0	Double buffer mode selected
RNG A	1	Range $\times 2$
RNG B	1	Range $\times 2$
RNG C	1	Range $\times 2$
RNG D	1	Range $\times 2$
SIA	0	Shutdown affects DACA according to ACT state
SIB	0	Shutdown affects DACB according to ACT state
SIC	0	Shutdown affects DACC according to ACT state
SID	0	Shutdown affects DACD according to ACT state
ACT	0	DACs in shutdown state



POST OFFICE BOX 655303 • DALLAS, TEXAS 75265

# TLV5621E LOW-POWER QUADRUPLE 8-BIT DIGITAL-TO-ANALOG CONVERTER

SLAS138 – APRIL 1996

## linearity, offset, and gain error using single-end supplies

When an amplifier is operated from a single supply, the voltage offset can still be either positive or negative. With a positive offset, the output voltage changes on the first code change. With a negative offset the output voltage may not change with the first code depending on the magnitude of the offset voltage.

The output amplifier, with a negative voltage offset, attempts to drive the output to a negative voltage. However, because the most negative supply rail is ground, the output cannot drive to a negative voltage.

So when the output offset voltage is negative, the output voltage remains at zero until the input code value produces a sufficient output voltage to overcome the inherent negative offset voltage, resulting in the transfer function shown in Figure 5.

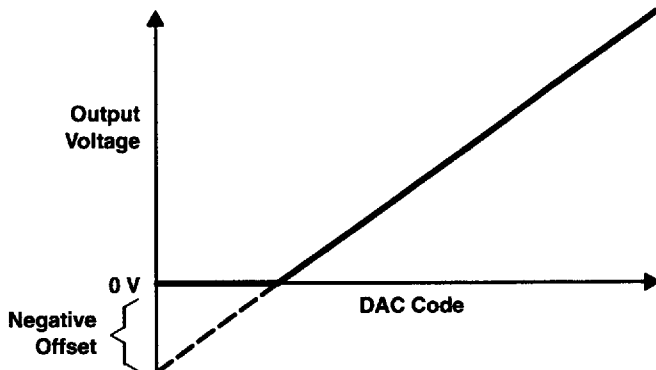

Figure 5. Effect of Negative Offset (Single Supply)

This negative offset error, not the linearity error, produces the breakpoint. The transfer function would have followed the dotted line if the output buffer could drive to a negative voltage.

For a DAC, linearity is measured between zero input code (all inputs 0) and full scale code (all inputs 1) after offset and full scale are adjusted out or accounted for in some way. However, single-supply operation does not allow for adjustment when the offset is negative due to the breakpoint in the transfer function. So the linearity in the unipolar mode is measured between full scale code and the lowest code which produces a positive output voltage.

The code is calculated from the maximum specification for the negative offset.

## equivalent inputs and outputs

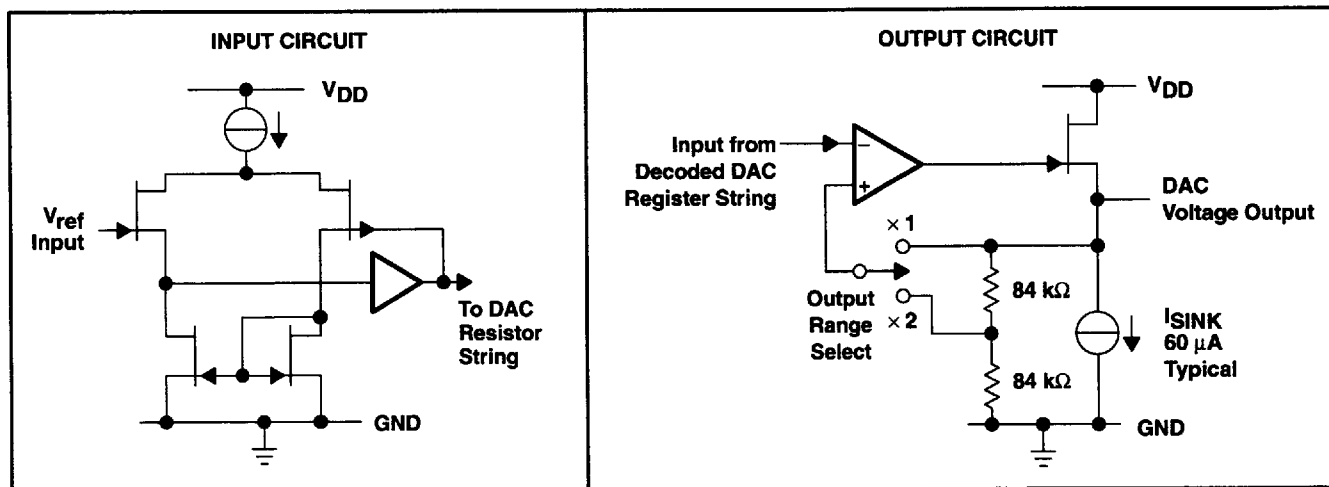

# TLV5621E

## LOW-POWER QUADRUPLE 8-BIT DIGITAL-TO-ANALOG CONVERTER

SLAS138 – APRIL 1996

### absolute maximum ratings over operating free-air temperature range (unless otherwise noted)†

Supply voltage ( $V_{DD} - GND$ )	7 V
Digital input voltage range	$GND - 0.3 V$ to $V_{DD} + 0.3 V$
Reference input voltage range, $V_{ID}$	$GND - 0.3 V$ to $V_{DD} + 0.3 V$
Operating free-air temperature range, $T_A$	$-25^{\circ}C$ to $85^{\circ}C$
Storage temperature range, $T_{stg}$	$-50^{\circ}C$ to $150^{\circ}C$
Lead temperature 1,6 mm (1/16 inch) from case for 10 seconds	$230^{\circ}C$

† Stresses beyond those listed under “absolute maximum ratings” may cause permanent damage to the device. These are stress ratings only, and functional operation of the device at these or any other conditions beyond those indicated under “recommended operating conditions” is not implied. Exposure to absolute-maximum-rated conditions for extended periods may affect device reliability.

### recommended operating conditions

	MIN	NOM	MAX	UNIT
Supply voltage, $V_{DD}$ (see Note 2)	2.7	3.3	5.5	V
High-level digital input voltage, $V_{IH}$	$0.8 V_{DD}$			V
Low-level digital input voltage, $V_{IL}$	$0.2 V_{DD}$			V
Reference voltage, $V_{ref}$ [AIBICID], x1 gain	GND	$V_{DD} - 1.5$		V
Load resistance, $R_L$	10			k $\Omega$
Setup time, data input, $t_{su}(DATA-CLK)$ (see Figure 6)	50			ns
Hold time, data input valid after $CLK\downarrow$ , $t_h(DATA-CLK)$ (see Figure 6)	50			ns
Setup time, $CLK\downarrow$ to $EN\downarrow$ , $t_{su}(CLK-EN)$ (see Figure 7)	100			ns
Setup time, $EN\uparrow$ to $CLK\downarrow$ , $t_{su}(EN-CLK)$ (see Figure 7) (see Note 3)	100			ns
Pulse duration, EN low, $t_w(EN)$ (see Figure 7) (see Note 3)	200			ns
Pulse duration, CLK high, $t_w(CLK)$ (see Figure 6) (see Note 3)	400			ns
CLK frequency	1			MHz
Operating free-air temperature, $T_A$	-25	85		$^{\circ}C$

- NOTES: 2. The device operates over the supply voltage range of 2.7 V to 5.5 V. Over this voltage range the device responds correctly to data input by changing the output voltage but conversion accuracy is not specified over this extended range.  
 3. This is specified by design but is not production tested.



# TLV5621E

## LOW-POWER QUADRUPLE 8-BIT DIGITAL-TO-ANALOG CONVERTER

SLAS138 – APRIL 1996

electrical characteristics over recommended operating free-air temperature range,  
 $V_{DD} = 3\text{ V to }3.6\text{ V}$ ,  $V_{ref} = 1.25\text{ V}$ ,  $GND = 0\text{ V}$ ,  $R_L = 10\text{ k}\Omega$ ,  $C_L = 100\text{ pF}$ ,  $\times 1$  gain output range  
 (unless otherwise noted)

PARAMETER		TEST CONDITIONS	MIN	TYP	MAX	UNIT
$V_{Omax}$	Maximum full-scale output voltage	$V_{ref} = 1.5\text{ V}$ , open circuit output, $\times 2$ gain	$V_{DD} - 100$	2		mV
$I_{IH}(\text{digital})$	High-level digital input current	$V_I = V_{DD}$			$\pm 10$	$\mu\text{A}$
$I_{IL}(\text{digital})$	Low-level digital input current	$V_I = 0\text{ V}$			$\pm 10$	$\mu\text{A}$
$I_{O}(\text{sink})$	Output sink current, DACA	DAC code 0	5			$\mu\text{A}$
	Output sink current, DACB, DACC, DADC	DAC code 0	20			$\mu\text{A}$
$I_{O}(\text{source})$	Output source current	Each DAC output, DAC code 255	1			mA
$C_i$	Input capacitance			15		pF
	Reference input capacitance	A, B, C, D inputs		15		
$I_{DD}$	Supply current	$V_{DD} = 3.6\text{ V}$		1	1.5	mA
		$V_{DD} = 5\text{ V}$		1	1.5	mA
$I_{DD}(\text{active})$	Supply current, one low power DAC active	$V_{DD} = 3.6\text{ V}$ (see Note 4)		150	250	$\mu\text{A}$
$I_{DD}(\text{shutdown})$	Supply current, all DACs shut down	$V_{DD} = 3.6\text{ V}$ (see Note 4)		50	100	$\mu\text{A}$
$I_{ref}$	Reference input current	A, B, C, D inputs			$\pm 10$	$\mu\text{A}$
$E_L$	Integral linearity error	$V_{ref} = 1.25\text{ V}$ , $\times 2$ gain (see Notes 5 and 13)			$\pm 1$	LSB
$E_D$	Differential linearity error	$V_{ref} = 1.25\text{ V}$ , $\times 2$ gain (see Notes 6 and 13)		$\pm 0.1$	$\pm 0.9$	LSB
$E_{ZS}$	Zero-scale error	$V_{ref} = 1.25\text{ V}$ , $\times 2$ gain (see Note 7)	0		30	mV
	Zero-scale error temperature coefficient	$V_{ref} = 1.25\text{ V}$ , $\times 2$ gain (see Note 8)		10		$\mu\text{V}/^\circ\text{C}$
	Zero-scale error supply rejection			2		mV/V
$E_{FS}$	Full-scale error	$V_{ref} = 1.25\text{ V}$ , $\times 2$ gain (see Note 9)			$\pm 60$	mV
	Full-scale error temperature coefficient	$V_{ref} = 1.25\text{ V}$ , $\times 2$ gain (see Note 10)		$\pm 25$		$\mu\text{V}/^\circ\text{C}$
	Full-scale error supply rejection			2		mV/V
PSRR	Power-supply sensitivity	See Notes 11 and 12		0.5		mV/V
	Feedback resistor network resistance			168		k $\Omega$

- NOTES:
- This is measured with no load (open circuit output),  $V_{ref} = 1.25\text{ V}$ , range =  $\times 2$ .
  - Integral nonlinearity (INL) is the maximum deviation of the output from the line between zero and full scale (excluding the effects of zero code and full-scale errors).
  - Differential nonlinearity (DNL) is the difference between the measured and ideal 1 LSB amplitude change of any two adjacent codes. Monotonic means the output voltage changes in the same direction (or remains constant) as a change in the digital input code.
  - Zero-scale error is the deviation from zero voltage output when the digital input code is zero.
  - Zero-scale error temperature coefficient is given by:  $ZSETC = [ZSE(T_{max}) - ZSE(T_{min})]/V_{ref} \times 10^6/(T_{max} - T_{min})$ .
  - Full-scale error is the deviation from the ideal full-scale output ( $V_{ref} - 1\text{ LSB}$ ) with an output load of  $10\text{ k}\Omega$ .
  - Full-scale temperature coefficient is given by:  $FSETC = [FSE(T_{max}) - FSE(T_{min})]/V_{ref} \times 10^6/(T_{max} - T_{min})$ .
  - Zero-scale error rejection ratio (ZSE-RR) is measured by varying the  $V_{DD}$  voltage from  $4.5\text{ V}$  to  $5.5\text{ V}$  dc and measuring the effect of this signal on the zero-code output voltage.
  - Full-scale error rejection ratio (FSE-RR) is measured by varying the  $V_{DD}$  voltage from  $3\text{ V}$  to  $3.6\text{ V}$  dc and measuring the effect of this signal on the full-scale output voltage.
  - Linearity is only specified for DAC codes 1 through 255.



# TLV5621E

## LOW-POWER QUADRUPLE 8-BIT DIGITAL-TO-ANALOG CONVERTER

SLAS138 – APRIL 1996

**operating characteristics over recommended operating free-air temperature range,  $V_{DD} = 3\text{ V to }3.6\text{ V}$ ,  $V_{ref} = 1.25\text{ V}$ ,  $GND = 0\text{ V}$ ,  $R_L = 10\text{ k}\Omega$ ,  $C_L = 100\text{ pF}$ ,  $\times 1$  gain output range (unless otherwise noted)**

PARAMETER	TEST CONDITIONS	MIN	TYP	MAX	UNIT
Output slew rate, rising (DACA)			0.8		V/ $\mu$ s
Output slew rate, falling (DACA)			0.5		V/ $\mu$ s
Output slew rate (DACB, DACC, DACD)			1		V/ $\mu$ s
Output settling time, rising (DACA)	To 1/2 LSB, $V_{DD} = 3\text{ V}$		20		$\mu$ s
Output settling time, falling (DACA)	To 1/2 LSB, $V_{DD} = 3\text{ V}$		75		$\mu$ s
Output settling time, rising (DACB, DACC, DACD)	To 1/2 LSB, $V_{DD} = 3\text{ V}$		10		$\mu$ s
Output settling time, falling (DACB, DACC, DACD)	To 1/2 LSB, $V_{DD} = 3\text{ V}$		75		$\mu$ s
Output settling time, HWACT or ACT $\uparrow$ to output volts (DACA) (see Note 14)	To 1/2 LSB, $V_{DD} = 3\text{ V}$		40	120 $\uparrow$	$\mu$ s
Output settling time, HWACT or ACT $\uparrow$ to output volts (DACB, DACC, DACD) (see Note 14)	To 1/2 LSB, $V_{DD} = 3\text{ V}$		25	75 $\uparrow$	$\mu$ s
Large-signal bandwidth	Measured at $-3\text{ dB}$ point		100		kHz
Digital crosstalk	CLK = 1-MHz square wave measured at DACA–DACD		-50		dB
Reference feedthrough	A, B, C, D inputs (see Note 15)		-60		dB
Channel-to-channel isolation	A, B, C, D inputs (see Note 16)		-60		dB
Channel-to-channel isolation when in shutdown	A, B, C, D inputs		-40		dB
Reference bandwidth (DACA)	See Note 17		20		kHz
Reference bandwidth (DACB, DACC, DACD)	See Note 17		100		kHz

$\uparrow$  This is specified by characterization but is not production tested.

NOTES: 14. The ACT bit is latched on EN $\downarrow$ .

15. Reference feedthrough is measured at any DAC output with an input code = 00 hex with a  $V_{ref}$  input = 1 V dc + 1 V $_{pp}$  at 10 kHz.
16. Channel-to-channel isolation is measured by setting the input code of one DAC to FF hex and the code of all other DACs to 00 hex with  $V_{ref}$  input = 1 V dc + 1 V $_{pp}$  at 10 kHz.
17. Reference bandwidth is the  $-3\text{ dB}$  bandwidth with an ideal input at  $V_{ref} = 1.25\text{ V dc} + 2\text{ V}_{pp}$  and with a digital input code of full-scale (range set to  $\times 1$  and  $V_{DD} = 5\text{ V}$ ).



POST OFFICE BOX 655303 • DALLAS, TEXAS 75265

# TLV5621E LOW-POWER QUADRUPLE 8-BIT DIGITAL-TO-ANALOG CONVERTER

SLAS138 – APRIL 1996

## PARAMETER MEASUREMENT INFORMATION

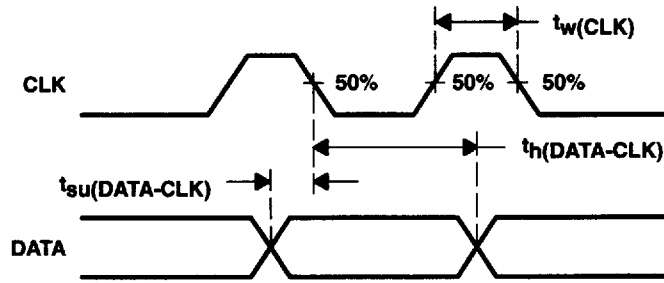

Figure 6. Timing of DATA Relative to CLK

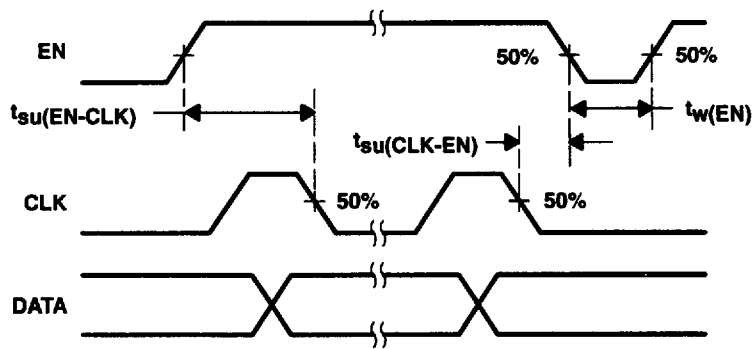

Figure 7. Timing of CLK Relative to EN

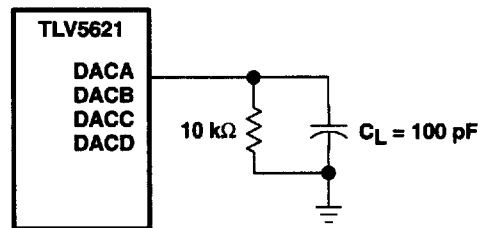

Figure 8. Slewing Settling Time and Linearity Measurements

# TLV5621E

## LOW-POWER QUADRUPLE 8-BIT DIGITAL-TO-ANALOG CONVERTER

SLAS138 – APRIL 1996

### TYPICAL CHARACTERISTICS

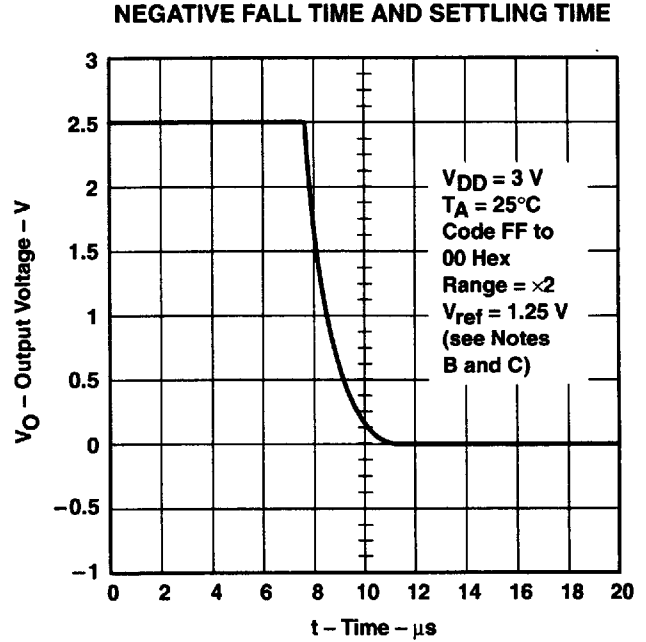
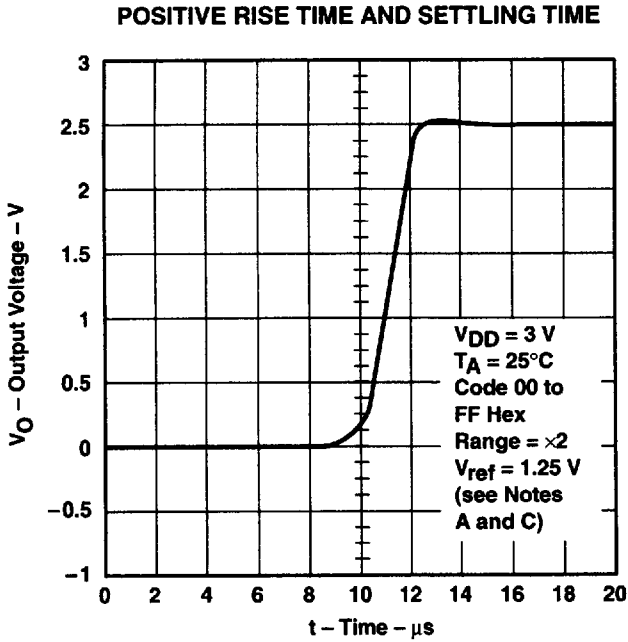

- NOTES: A. Rise time = 2.05  $\mu\text{s}$ , positive slew rate = 0.96 V/ $\mu\text{s}$ , settling time = 4.5  $\mu\text{s}$ .  
 B. Fall time = 4.25  $\mu\text{s}$ , negative slew rate = 0.46 V/ $\mu\text{s}$ , settling time = 8.5  $\mu\text{s}$ .  
 C. For DACB, DACC, and DACD

**Figure 9**

**Figure 10**

# TLV5621E LOW-POWER QUADRUPLE 8-BIT DIGITAL-TO-ANALOG CONVERTER

SLAS138 – APRIL 1996

## TYPICAL CHARACTERISTICS

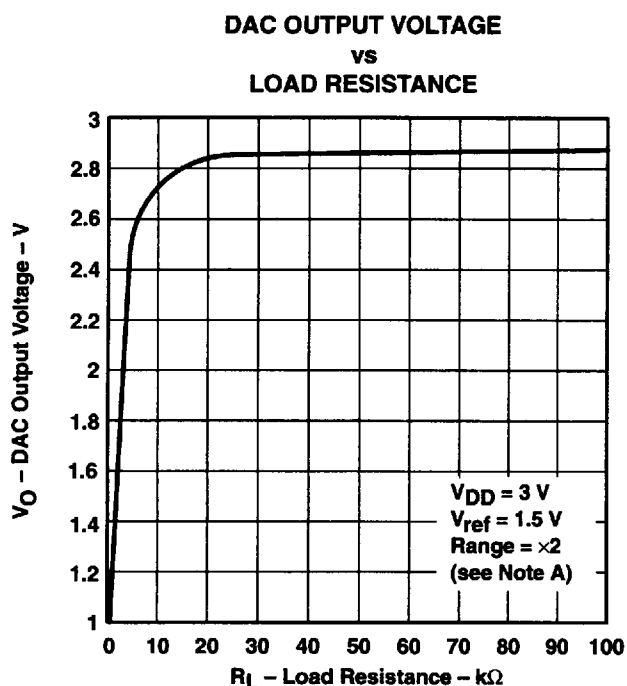

NOTE A: For DACB, DACC, and DACD

Figure 11

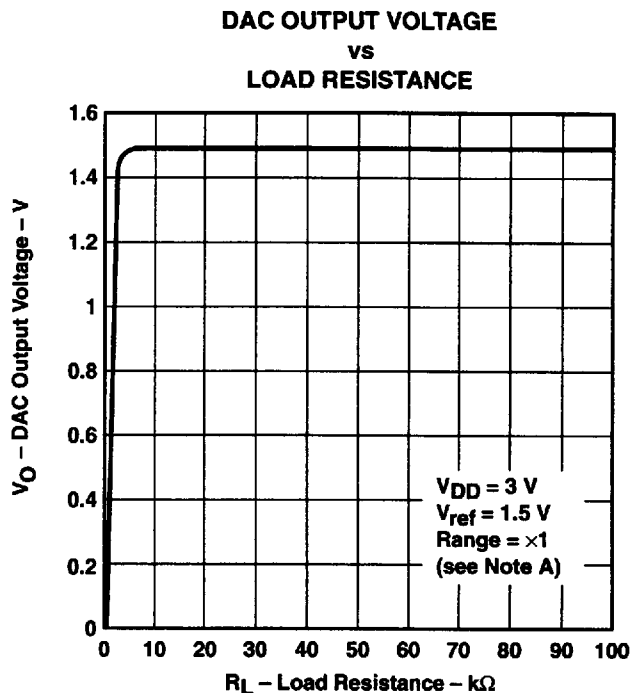

NOTE A: For DACB, DACC, and DACD

Figure 12

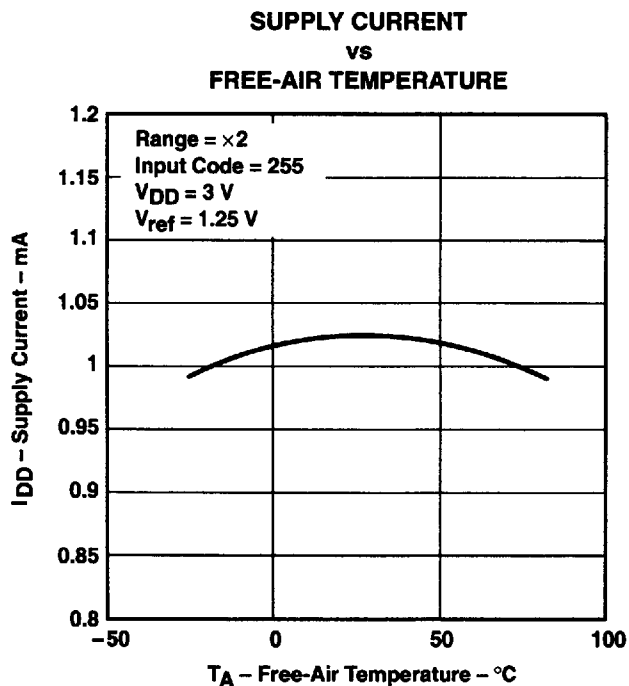

Figure 13



POST OFFICE BOX 655303 • DALLAS, TEXAS 75265



APPLICATION INFORMATION

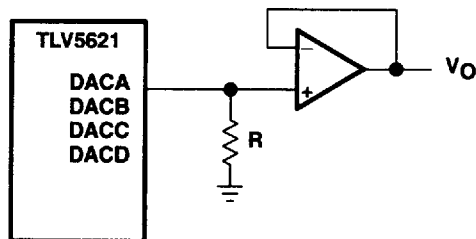

NOTE A: Resistor  $R \geq 10 \text{ k}\Omega$

Figure 14. Output Buffering Scheme

# TLV5621E LOW-POWER QUADRUPLE 8-BIT DIGITAL-TO-ANALOG CONVERTER

SLAS138 - APRIL 1996

## MECHANICAL DATA

D (R-PDSO-G\*\*)

PLASTIC SMALL-OUTLINE PACKAGE

14 PIN SHOWN

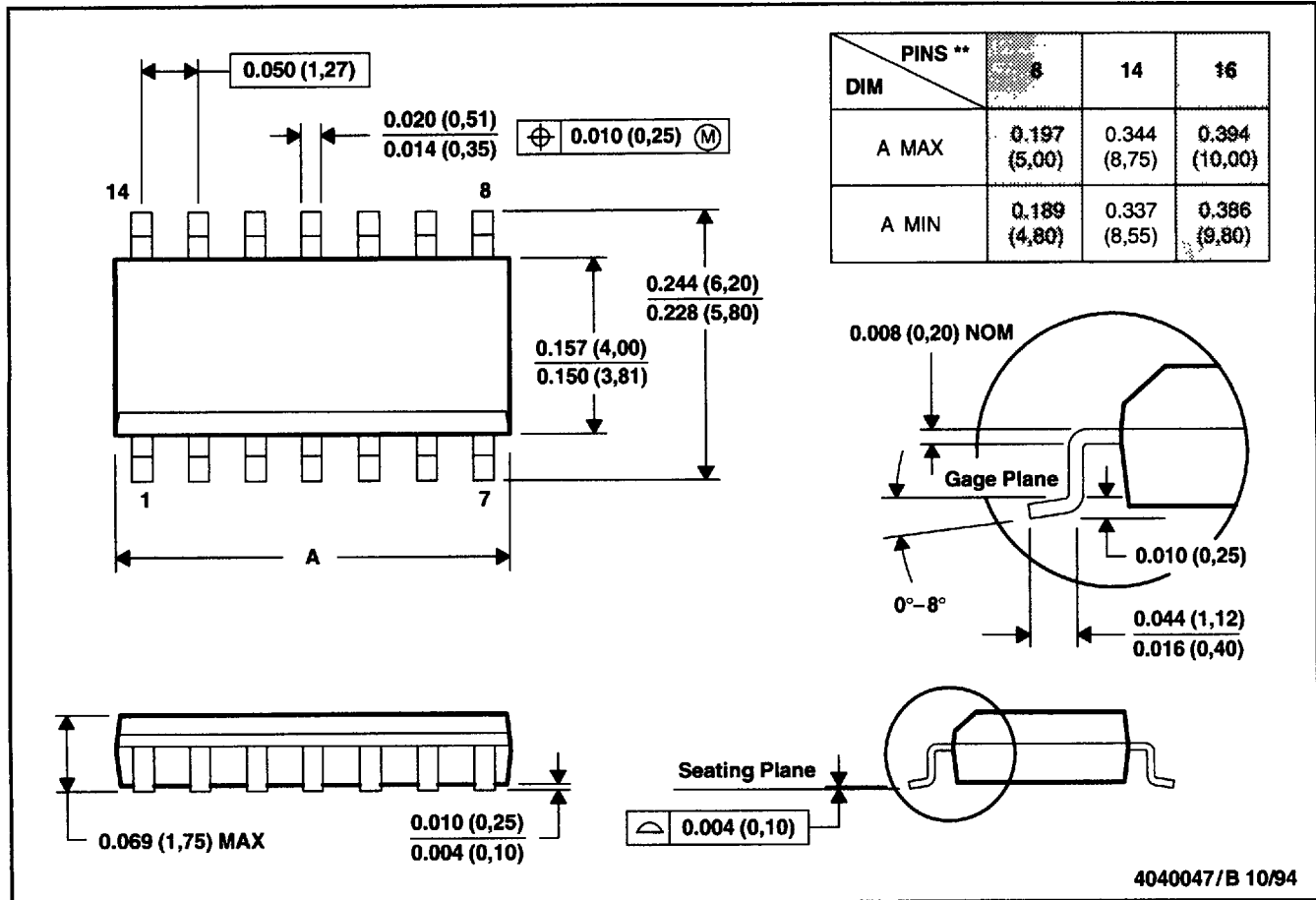

- NOTES: A. All linear dimensions are in inches (millimeters).  
 B. This drawing is subject to change without notice.  
 C. Body dimensions do not include mold flash or protrusion not to exceed 0.006 (0,15).  
 D. Four center pins are connected to die mount pad.  
 E. Falls within JEDEC MS-012

# TLV5621E LOW-POWER QUADRUPLE 8-BIT DIGITAL-TO-ANALOG CONVERTER

SLAS138 – APRIL 1996

## MECHANICAL DATA

**N (R-PDIP-T\*\*)**

**PLASTIC DUAL-IN-LINE PACKAGE**

16 PIN SHOWN

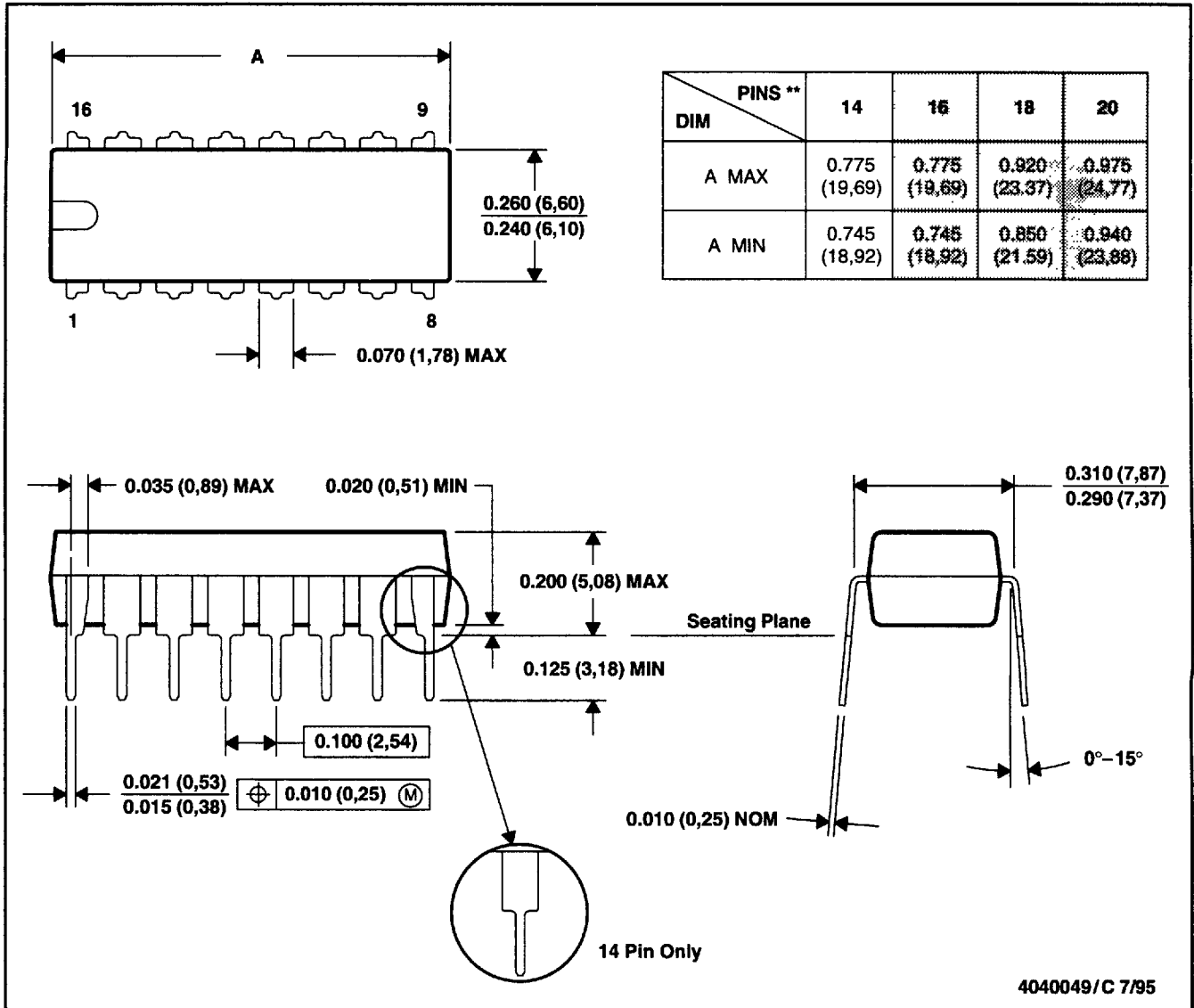

- NOTES: A. All linear dimensions are in inches (millimeters).  
 B. This drawing is subject to change without notice.  
 C. Falls within JEDEC MS-001 (20-pin package is shorter than MS-001)



POST OFFICE BOX 655303 • DALLAS, TEXAS 75265