

### FEATURES

- 16-bit resolution and monotonicity**
- Dynamic power control for thermal management**
- Current and voltage output pins connectable to a single terminal**
- Current output ranges: 0 mA to 20 mA, 4 mA to 20 mA, or 0 mA to 24 mA**
- ±0.05% total unadjusted error (TUE) maximum**
- Voltage output ranges (with 20% overrange): 0 V to 5 V, 0 V to 10 V, ±5 V, and ±10 V**
- ±0.04% total unadjusted error (TUE) maximum**
- User programmable offset and gain**
- On-chip diagnostics**
- On-chip reference (±10 ppm/°C maximum)**
- −40°C to +105°C temperature range**

### APPLICATIONS

- Process control
- Actuator control
- Programmable logic controllers (PLCs)
- HART network connectivity

### GENERAL DESCRIPTION

The AD5755-1 is a quad, voltage and current output digital-to-analog converter (DAC) that operates with a power supply range from −26.4 V to +33 V. On-chip dynamic power control minimizes package power dissipation in current mode. This is

achieved by regulating the voltage on the output driver from 7.4 V to 29.5 V using a dc-to-dc boost converter optimized for minimum on-chip power dissipation. Each channel has a corresponding CHART pin so that HART signals can be coupled onto the current output of the AD5755-1.

The device uses a versatile 3-wire serial interface that operates at clock rates of up to 30 MHz and is compatible with standard SPI, QSPI™, MICROWIRE™, DSP, and microcontroller interface standards. The interface also features optional CRC-8 packet error checking, as well as a watchdog timer that monitors activity on the interface.

### PRODUCT HIGHLIGHTS

1. Dynamic power control for thermal management.
2. 16-bit performance.
3. Multichannel.
4. HART compliant.

### COMPANION PRODUCTS

- Product Family:** AD5755, AD5757
- HART Modem:** AD5700, AD5700-1
- External References:** ADR445, ADR02
- Digital Isolators:** ADuM1410, ADuM1411
- Power:** ADP2302, ADP2303
- Additional companion products on the [AD5755-1 product page](#)*

### FUNCTIONAL BLOCK DIAGRAM

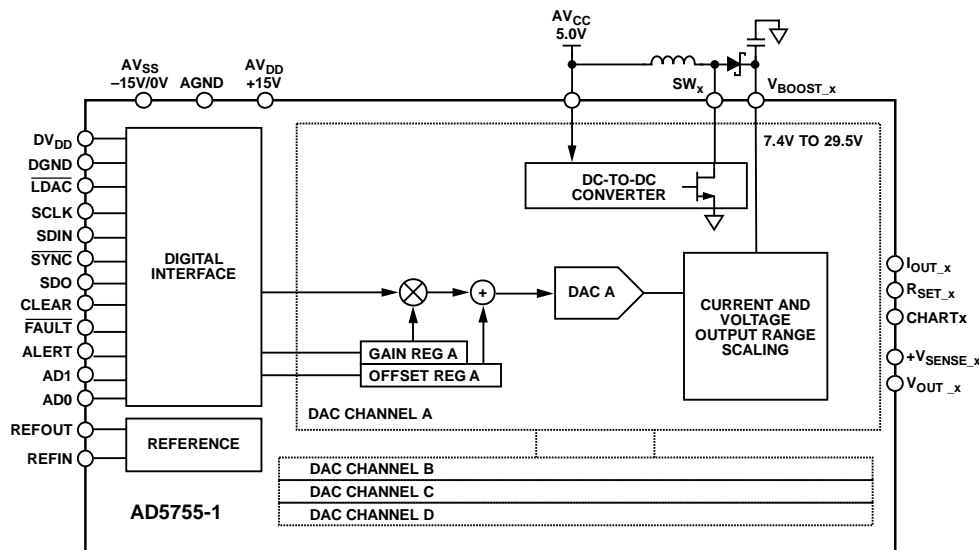

NOTES  
1. x = A, B, C, AND D.

Figure 1.

Rev. H

[Document Feedback](#)

Information furnished by Analog Devices is believed to be accurate and reliable. However, no responsibility is assumed by Analog Devices for its use, nor for any infringements of patents or other rights of third parties that may result from its use. Specifications subject to change without notice. No license is granted by implication or otherwise under any patent or patent rights of Analog Devices. Trademarks and registered trademarks are the property of their respective owners.

## TABLE OF CONTENTS

Features .....	1	Device Features.....	40
Applications .....	1	Output Fault.....	40
General Description .....	1	Voltage Output Short-Circuit Protection.....	40
Product Highlights .....	1	Digital Offset and Gain Control.....	40
Companion Products.....	1	Status Readback During a Write.....	40
Functional Block Diagram .....	1	Asynchronous Clear .....	41
Revision History .....	3	Packet Error Checking .....	41
Detailed Functional Block Diagram .....	4	Watchdog Timer .....	41
Specifications .....	5	Output Alert.....	41
AC Performance Characteristics.....	8	Internal Reference .....	41
Timing Characteristics .....	9	External Current Setting Resistor .....	41
Absolute Maximum Ratings .....	12	HART Connectivity.....	42
ESD Caution.....	12	Digital Slew Rate Control.....	42
Pin Configuration and Function Descriptions .....	13	Power Dissipation control .....	43
Typical Performance Characteristics.....	16	DC-to-DC Converters .....	43
Voltage Outputs .....	16	AI <sub>CC</sub> Supply Requirements—Static.....	44
Current Outputs .....	20	AI <sub>CC</sub> Supply Requirements—Slewing.....	44
DC-to-DC Block.....	24	Applications Information .....	46
Reference .....	25	Voltage and Current Output Ranges on the Same Terminal	46
General.....	26	.....	46
Terminology.....	27	Current Output Mode with Internal R <sub>SET</sub> .....	46
Theory of Operation .....	29	Precision Voltage Reference Selection .....	46
DAC Architecture .....	29	Driving Inductive Loads .....	47
Power-On State of the AD5755-1 .....	29	Transient Voltage Protection .....	47
Serial Interface .....	30	Microprocessor Interfacing .....	47
Transfer Function .....	30	Layout Guidelines .....	47
Registers.....	31	Galvanically Isolated Interface .....	48
Programming Sequence to Write/Enable the Output		Industrial HART Capable Analog Output Application—	
Correctly.....	32	Shared V <sub>OUT_x</sub> and I <sub>OUT_x</sub> Pin .....	49
Changing and Reprogramming the Range.....	32	Outline Dimensions.....	50
Data Registers .....	33	Ordering Guide .....	50
Control Registers.....	35		
Readback Operation .....	38		

**REVISION HISTORY****3/2021—Rev. G to Rev. H**

Changes to $t_6$ Parameter, Table 3 .....	9
Changes to Figure 8 .....	13
Updated Outline Dimensions .....	50
Changes to Ordering Guide.....	50

**4/2017—Rev. F to Rev. G**

Changes to Table 1, $DI_{CC}$ Parameter .....	8
Changes to Table 3.....	9
Changes to Figure 3 and Figure 4 .....	10
Changes to Figure 5 .....	11
Changes to the Readback Operation Section .....	38
Deleted Table 28 and Table 29, Renumbered Sequentially.....	38
Changes to Status Readback During a Write Section .....	40
Changes to Packet Error Checking Section.....	41
Updated Outline Dimensions .....	50

**9/2014—Rev. E to Rev. F**

Changes to Thermal Hysteresis Parameter, Table 1 .....	7
Changes to Table 3.....	9
Changes to Figure 4 .....	10
Added Figure 5; Renumbered Sequentially.....	11
Changes to Table 5.....	14
Changes to Figure 56 through Figure 59 .....	24
Change to Figure 70 and Figure 71 .....	26
Change to Voltage Reference Thermal Hysteresis Definition.....	27
Changes to Table 7.....	31
Changes to Offset Register Section, Table 12, and Table 14.....	34
Changes to Software Register Section, Table 22, and Table 23.....	37
Changes to Readback Operation Section, Added Table 28 and Table 29; Renumbered Sequentially .....	38
Changes to Status Register Section, Table 31, and Table 32 .....	40
Changes to Status Readback During a Write Section .....	41
Changes to Packet Error Checking Section.....	42
Changes to HART Connectivity Section .....	43
Changes to Table 36.....	44

**11/2012—Rev. D to Rev. E**

Changes to Figure 2 .....	4
Changed Thermal Impedance from 20°C/W to 28°C/W.....	12
Changes to Pin 6 Description.....	13
Changes to Pin 27 Description.....	14
Changes to Figure 26 .....	19
Changes to DUT_AD1, DUT_AD0 Description, Table 9 .....	33
Changes to Packet Error Checking Section and Internal Reference Section .....	41
Changes to Figure 81 .....	43
Changes to Figure 86 .....	47
Changes to Figure 89 .....	49

**7/2012—Rev. C to Rev. D**

Changes to Figure 89 .....	49
Updated Outline Dimensions .....	50

**5/2012—Rev. B to Rev. C**

Changes to Companion Products Section.....	1
Changes to Figure 2 .....	3
Changes to Table 5.....	15
Changes to Figure 22 .....	18
Added Industrial HART Capable Analog Output Application—Shared $V_{OUT\_X}$ and $I_{OUT\_X}$ Pin Section and Figure 89, Renumbered Sequentially .....	49
Updated Outline Dimensions .....	50

**11/2011—Rev. A to Rev. B**

Removed Voltage Output Test Conditions/Comments, Table 1 .5	
Changed Headroom and Footroom Test Conditions/Comments, Table 1 .....	5
Changes to Figure 4 .....	10
Changes to Figure 5 .....	11
Changes to SCLK Description, Table 5 .....	13
Changes to Figure 12 .....	16
Changes to Figure 21 .....	18
Changes to Figure 37 .....	20
Changes to Figure 44.....	22
Changes to Figure 71 .....	29
Changes to Power-On State of the AD5755-1 Section .....	30
Changes to Table 17.....	35
Changes to Readback Operation section and Table 26 .....	38
Changes to Voltage Output Short-Circuit Protection Section.	40
Changes to Figure 78 .....	41
Changes to Figure 82 .....	44
Changes to Figure 83, Figure 84, and Figure 85 .....	45
Changes to Transient Voltage Protection Section and Figure 86 .	47
Changes to Galvanically Isolated Interface Section .....	48

**5/2011—Rev. 0 to Rev. A**

Removed Endnote 6 (Table 1) .....	6
Changed $AV_{DD}$ Minimum Value from 10.8 V to 9 V .....	6
Changed $AI_{SS}$ Minimum Value from -1.4 mA to -1.7 mA.....	7
Changed $AV_{DD}$ Voltage in Pin 19 Description .....	13
Changes to Ordering Guide .....	48

**4/2011—Revision 0: Initial Version**

DETAILED FUNCTIONAL BLOCK DIAGRAM

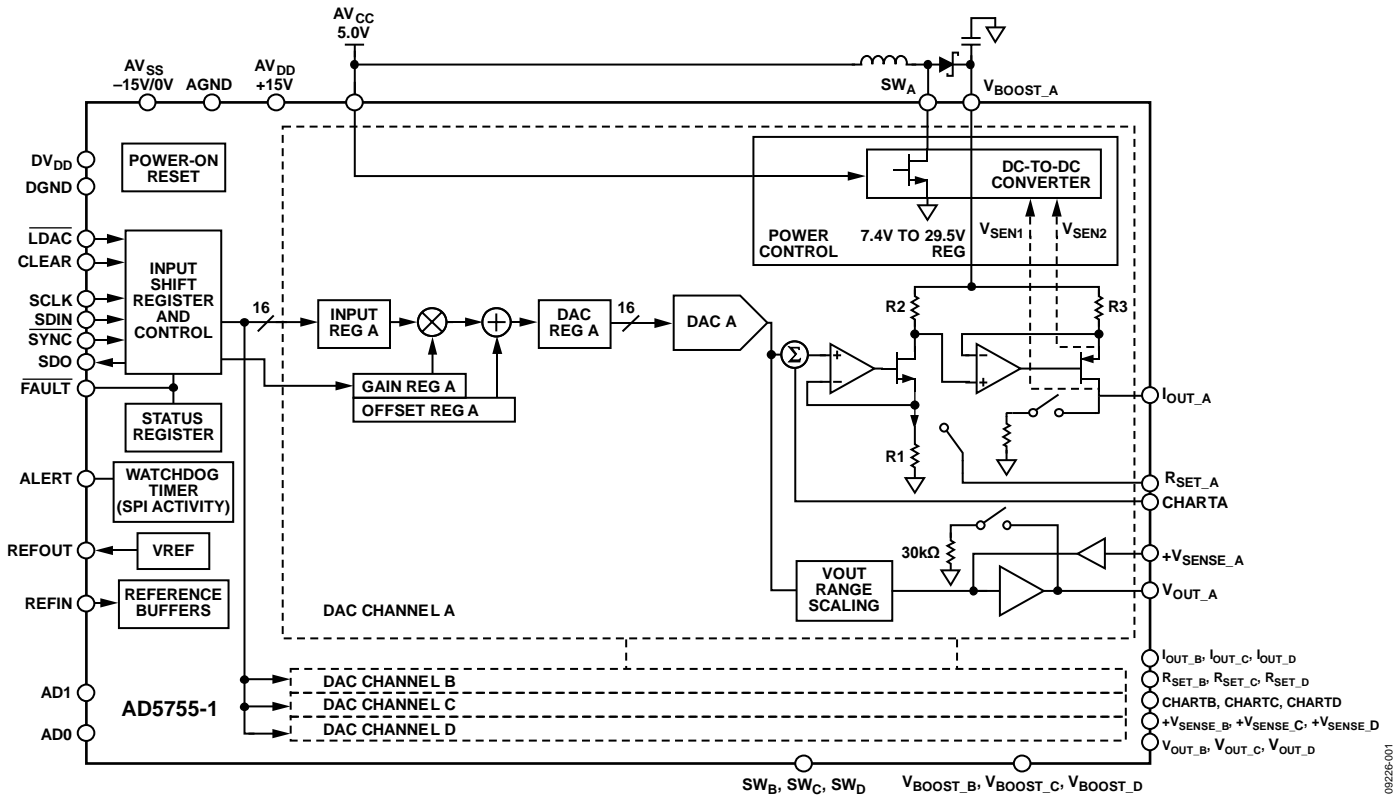

Figure 2.

## SPECIFICATIONS

$AV_{DD} = V_{BOOST,x} = 15\text{ V}$ ;  $AV_{SS} = -15\text{ V}/0\text{ V}$ ;  $DV_{DD} = 2.7\text{ V}$  to  $5.5\text{ V}$ ;  $AV_{CC} = 4.5\text{ V}$  to  $5.5\text{ V}$ ; dc-to-dc converter disabled;  $AGND = DGND = GND_{SW,x} = 0\text{ V}$ ;  $REFIN = 5\text{ V}$ ; voltage outputs:  $R_L = 1\text{ k}\Omega$ ,  $C_L = 220\text{ pF}$ ; current outputs:  $R_L = 300\ \Omega$ ; all specifications  $T_{MIN}$  to  $T_{MAX}$ , unless otherwise noted.

Table 1.

Parameter <sup>1</sup>	Min	Typ	Max	Unit	Test Conditions/Comments
<b>VOLTAGE OUTPUT</b>					
Output Voltage Ranges	0		5	V	
	0		10	V	
	-5		+5	V	
	-10		+10	V	
	0		6	V	
	0		12	V	
	-6		+6	V	
	-12		+12	V	
<b>ACCURACY BIPOLAR SUPPLY</b>					
Resolution	16			Bits	$AV_{SS} = -15\text{ V}$ , loaded and unloaded
Total Unadjusted Error (TUE)	-0.04		+0.04	% FSR	
	-0.03	$\pm 0.0032$	+0.03	% FSR	$T_A = 25^\circ\text{C}$
TUE Long-Term Stability		35		ppm FSR	Drift after 1000 hours, $T_J = 150^\circ\text{C}$
Relative Accuracy (INL)	-0.006	$\pm 0.0012$	+0.006	% FSR	0 V to 5 V, 0 V to 10 V, $\pm 5\text{ V}$ , $\pm 10\text{ V}$ ranges
	-0.008	$\pm 0.0012$	+0.008	% FSR	On overranges
Differential Nonlinearity (DNL)	-1		+1	LSB	Guaranteed monotonic
Zero-Scale Error	-0.03	$\pm 0.002$	+0.03	% FSR	
Zero-Scale $TC^2$		$\pm 2$		ppm FSR/ $^\circ\text{C}$	
Bipolar Zero Error	-0.03	$\pm 0.002$	+0.03	% FSR	
Bipolar Zero $TC^2$		$\pm 1$		ppm FSR/ $^\circ\text{C}$	
Offset Error	-0.03	$\pm 0.002$	+0.03	% FSR	
Offset $TC^2$		$\pm 2$		ppm FSR/ $^\circ\text{C}$	
Gain Error	-0.03	$\pm 0.004$	+0.03	% FSR	
Gain $TC^2$		$\pm 3$		ppm FSR/ $^\circ\text{C}$	
Full-Scale Error	-0.03	$\pm 0.002$	+0.03	% FSR	
Full-Scale $TC^2$		$\pm 2$		ppm FSR/ $^\circ\text{C}$	
<b>ACCURACY UNIPOLAR SUPPLY<sup>2</sup></b>					
Total Unadjusted Error (TUE)	-0.06	$\pm 0.025$	+0.06	% FSR	$AV_{SS} = 0\text{ V}$
Relative Accuracy (INL) <sup>3</sup>	-0.009		+0.009	% FSR	
Differential Nonlinearity (DNL)	-1		+1	LSB	Guaranteed monotonic
Zero-Scale Error		+0.22		% FSR	
Offset Error	-0.07	$\pm 0.025$	+0.07	% FSR	
Gain Error	-0.07	$\pm 0.015$	+0.07	% FSR	
Full-Scale Error	-0.06	$\pm 0.015$	+0.06	% FSR	
<b>OUTPUT CHARACTERISTICS<sup>2</sup></b>					
Headroom		1	2.2	V	With respect to $V_{BOOST}$ supply
Footroom		0.7	1.4	V	With respect to the $AV_{SS}$ supply, bipolar output ranges
Output Voltage Drift vs. Time		20		ppm FSR	Drift after 1000 hours, $\frac{3}{4}$ scale output, $T_J = 150^\circ\text{C}$ , $AV_{SS} = -15\text{ V}$
Short-Circuit Current	12/6	16/8		mA	Programmable by user, defaults to 16 mA typical level
Load	1			k $\Omega$	For specified performance

Parameter <sup>1</sup>	Min	Typ	Max	Unit	Test Conditions/Comments
Capacitive Load Stability			10	nF	External compensation capacitor of 220 pF connected
DC Output Impedance		0.06	2	$\mu$ F	
DC PSRR		50		$\mu$ V/V	
DC Crosstalk		24		$\mu$ V	
CURRENT OUTPUT					
Output Current Ranges	0		24	mA	
	0		20	mA	
	4		20	mA	
Resolution	16			Bits	
ACCURACY (EXTERNAL R <sub>SET</sub> )					Assumes ideal resistor, see the External Current Setting Resistor section for more information
Total Unadjusted Error (TUE)	-0.05	$\pm$ 0.009	+0.05	% FSR	Drift after 1000 hours, T <sub>J</sub> = 150°C
TUE Long-Term Stability		100		ppm FSR	
Relative Accuracy (INL)	-0.006		+0.006	% FSR	Guaranteed monotonic
Differential Nonlinearity (DNL)	-1		+1	LSB	
Offset Error	-0.05	$\pm$ 0.005	+0.05	% FSR	
Offset Error Drift <sup>2</sup>		$\pm$ 4		ppm FSR/°C	
Gain Error	-0.05	$\pm$ 0.004	+0.05	% FSR	
Gain TC <sup>2</sup>		$\pm$ 3		ppm FSR/°C	
Full-Scale Error	-0.05	$\pm$ 0.008	+0.05	% FSR	
Full-Scale TC <sup>2</sup>		$\pm$ 5		ppm FSR/°C	
DC Crosstalk		0.0005		% FSR	External R <sub>SET</sub>
ACCURACY (INTERNAL R <sub>SET</sub> )					
Total Unadjusted Error (TUE) <sup>4,5</sup>	-0.14		+0.14	% FSR	T <sub>A</sub> = 25°C
	-0.11	$\pm$ 0.009	+0.11	% FSR	
TUE Long-Term Stability		180		ppm FSR	Drift after 1000 hours, T <sub>J</sub> = 150°C
Relative Accuracy (INL)	-0.006		+0.006	% FSR	T <sub>A</sub> = 25°C
Relative Accuracy (INL)	-0.004		+0.004	% FSR	
Differential Nonlinearity (DNL)	-1		+1	LSB	Guaranteed monotonic
Offset Error <sup>4,5</sup>	-0.05		+0.05	% FSR	T <sub>A</sub> = 25°C
	-0.04	$\pm$ 0.007	+0.04	% FSR	
Offset Error Drift <sup>2</sup>		$\pm$ 6		ppm FSR/°C	T <sub>A</sub> = 25°C
Gain Error	-0.12		+0.12	% FSR	
	-0.06	$\pm$ 0.002	+0.06	% FSR	T <sub>A</sub> = 25°C
Gain TC <sup>2</sup>		$\pm$ 9		ppm FSR/°C	T <sub>A</sub> = 25°C
Full-Scale Error <sup>4,5</sup>	-0.14		+0.14	% FSR	
	-0.1	$\pm$ 0.007	+0.1	% FSR	T <sub>A</sub> = 25°C
Full-Scale TC <sup>2</sup>		$\pm$ 14		ppm FSR/°C	Internal R <sub>SET</sub>
DC Crosstalk <sup>5</sup>		-0.011		% FSR	
OUTPUT CHARACTERISTICS <sup>2</sup>					
Current Loop Compliance Voltage		V <sub>BOOST_x</sub> - 2.4	V <sub>BOOST_x</sub> - 2.7	V	Drift after 1000 hours, ¾ scale output, T <sub>J</sub> = 150°C
Output Current Drift vs. Time		90		ppm FSR	
		140		ppm FSR	
Resistive Load			1000	$\Omega$	
Output Impedance		100		M $\Omega$	The dc-to-dc converter has been characterized with a maximum load of 1 k $\Omega$ , chosen such that compliance is not exceeded; see Figure 54 and DC-DC MaxV bits in Table 25
DC PSRR		0.02	1	$\mu$ A/V	

Parameter <sup>1</sup>	Min	Typ	Max	Unit	Test Conditions/Comments
<b>REFERENCE INPUT/OUTPUT</b>					
Reference Input <sup>2</sup>					
Reference Input Voltage	4.95	5	5.05	V	For specified performance
DC Input Impedance	45	150		MΩ	
Reference Output					
Output Voltage	4.995	5	5.005	V	T <sub>A</sub> = 25°C
Reference TC <sup>2</sup>	-10	±5	+10	ppm/°C	
Output Noise (0.1 Hz to 10 Hz) <sup>2</sup>		7		μV p-p	
Noise Spectral Density <sup>2</sup>		100		nV/√Hz	At 10 kHz
Output Voltage Drift vs. Time <sup>2</sup>		180		ppm	Drift after 1000 hours, T <sub>J</sub> = 150°C
Capacitive Load <sup>2</sup>		1000		nF	
Load Current		9		mA	See Figure 65
Short-Circuit Current		10		mA	
Line Regulation <sup>2</sup>		3		ppm/V	See Figure 65
Load Regulation <sup>2</sup>		95		ppm/mA	See Figure 65
Thermal Hysteresis <sup>2</sup>		200		ppm	
<b>DC-TO-DC</b>					
Switch					
Switch On Resistance		0.425		Ω	
Switch Leakage Current		10		nA	
Peak Current Limit		0.8		A	
Oscillator					
Oscillator Frequency	11.5	13	14.5	MHz	This oscillator is divided down to give the dc-to-dc converter switching frequency
Maximum Duty Cycle		89.6		%	At 410 kHz dc-to-dc switching frequency
<b>DIGITAL INPUTS<sup>2</sup></b>					
JEDEC compliant					
V <sub>IH</sub> , Input High Voltage	2			V	
V <sub>IL</sub> , Input Low Voltage			0.8	V	
Input Current	-1		+1	μA	Per pin
Pin Capacitance		2.6		pF	Per pin
<b>DIGITAL OUTPUTS<sup>2</sup></b>					
SDO, ALERT					
V <sub>OL</sub> , Output Low Voltage			0.4	V	Sinking 200 μA
V <sub>OH</sub> , Output High Voltage	DVDD - 0.5			V	Sourcing 200 μA
High Impedance Leakage Current	-1		+1	μA	
High Impedance Output Capacitance		2.5		pF	
<b>FAULT</b>					
V <sub>OL</sub> , Output Low Voltage			0.4	V	10 kΩ pull-up resistor to DVDD
V <sub>OL</sub> , Output Low Voltage		0.6		V	At 2.5 mA
V <sub>OH</sub> , Output High Voltage	3.6			V	10 kΩ pull-up resistor to DVDD
<b>POWER REQUIREMENTS</b>					
AV <sub>DD</sub>	9		33	V	
AV <sub>SS</sub>	-26.4		-10.8/0	V	
DV <sub>DD</sub>	2.7		5.5	V	
AV <sub>CC</sub>	4.5		5.5	V	

Parameter <sup>1</sup>	Min	Typ	Max	Unit	Test Conditions/Comments
$I_{DD}$		8.6	10.5	mA	Voltage output mode on all channels, output unloaded, over supplies
$I_{SS}$		7	7.5	mA	Current output mode on all channels
	-11	-8.8		mA	Voltage output mode on all channels, output unloaded, over supplies
	-1.7			mA	Current output mode on all channels
$I_{CC}$		4	6	mA	$V_{IH} = DV_{DD}$ , $V_{IL} = DGND$ , internal oscillator running, over supplies
$I_{CC}$			1	mA	Output unloaded, over supplies
$I_{BOOST}$			2.7	mA	Per channel, voltage output mode, output unloaded, over supplies
$I_{BOOST}^6$			1	mA	Per channel, current output mode, 0 mA output
Power Dissipation		173		mW	$AV_{DD} = +15\text{ V}$ , $AV_{SS} = -15\text{ V}$ , dc-to-dc converter enable, current output mode, outputs disabled

<sup>1</sup> Temperature range:  $-40^{\circ}\text{C}$  to  $+105^{\circ}\text{C}$ ; typical at  $+25^{\circ}\text{C}$ .

<sup>2</sup> Guaranteed by design and characterization; not production tested.

<sup>3</sup> For voltage output ranges in unipolar supply mode, the INL and TUE are measured beginning from Code 4096.

<sup>4</sup> For current outputs with internal  $R_{SET}$ , the offset, full-scale, and TUE measurements exclude dc crosstalk. The measurements are made with all four channels enabled loaded with the same code.

<sup>5</sup> See the Current Output Mode with Internal  $R_{SET}$  section for more explanation of the dc crosstalk.

<sup>6</sup> Efficiency plots in Figure 56, Figure 57, Figure 58, and Figure 59 include the  $I_{BOOST}$  quiescent current.

## AC PERFORMANCE CHARACTERISTICS

$AV_{DD} = V_{BOOST\_x} = 15\text{ V}$ ;  $AV_{SS} = -15\text{ V}$ ;  $DV_{DD} = 2.7\text{ V}$  to  $5.5\text{ V}$ ;  $AV_{CC} = 4.5\text{ V}$  to  $5.5\text{ V}$ ; dc-to-dc converter disabled;  $AGND = DGND = GND_{SW\_x} = 0\text{ V}$ ;  $REFIN = 5\text{ V}$ ; voltage outputs:  $R_L = 2\text{ k}\Omega$ ,  $C_L = 220\text{ pF}$ ; current outputs:  $R_L = 300\ \Omega$ ; all specifications  $T_{MIN}$  to  $T_{MAX}$ , unless otherwise noted.

Table 2.

Parameter <sup>1</sup>	Min	Typ	Max	Unit	Test Conditions/Comments
DYNAMIC PERFORMANCE					
Voltage Output					
Output Voltage Settling Time		11		$\mu\text{s}$	5 V step to $\pm 0.03\%$ FSR, 0 V to 5 V range
			18	$\mu\text{s}$	10 V step to $\pm 0.03\%$ FSR, 0 V to 10 V range
			13	$\mu\text{s}$	100 mV step to 1 LSB (16-bit LSB), 0 V to 10 V range
Slew Rate		1.9		$\text{V}/\mu\text{s}$	0 V to 10 V range
Power-On Glitch Energy		150		nV-sec	
Digital-to-Analog Glitch Energy		6		nV-sec	
Glitch Impulse Peak Amplitude		25		mV	
Digital Feedthrough		1		nV-sec	
DAC to DAC Crosstalk		2		nV-sec	0 V to 10 V range
Output Noise (0.1 Hz to 10 Hz Bandwidth)		0.15		LSB p-p	16-bit LSB, 0 V to 10 V range
Output Noise Spectral Density		150		$\text{nV}/\sqrt{\text{Hz}}$	Measured at 10 kHz, midscale output, 0 V to 10 V range
AC PSRR		83		dB	200 mV 50 Hz/60 Hz sine wave superimposed on power supply voltage
Current Output					
Output Current Settling Time		15		$\mu\text{s}$	To 0.1% FSR (0 mA to 24 mA)
		See test conditions/ comments		ms	See Figure 50, Figure 51, and Figure 52
Output Noise (0.1 Hz to 10 Hz Bandwidth)		0.15		LSB p-p	16-bit LSB, 0 mA to 24 mA range
Output Noise Spectral Density		0.5		$\text{nA}/\sqrt{\text{Hz}}$	Measured at 10 kHz, midscale output, 0 mA to 24 mA range

<sup>1</sup> Guaranteed by design and characterization; not production tested.



**TIMING CHARACTERISTICS**

$V_{DD} = V_{BOOST\_X} = 15\text{ V}$ ;  $V_{SS} = -15\text{ V}$ ;  $DV_{DD} = 2.7\text{ V to }5.5\text{ V}$ ;  $AV_{CC} = 4.5\text{ V to }5.5\text{ V}$ ; dc-to-dc converter disabled;  $AGND = DGND = GND$ ;  $SW_X = 0\text{ V}$ ;  $REFIN = 5\text{ V}$ ; voltage outputs:  $R_L = 1\text{ k}\Omega$ ,  $C_L = 220\text{ pF}$ ; current outputs:  $R_L = 300\ \Omega$ ; all specifications  $T_{MIN}$  to  $T_{MAX}$ , unless otherwise noted.

**Table 3.**

Parameter <sup>1, 2, 3</sup>	Limit at $T_{MIN}$ , $T_{MAX}$	Unit	Description
$t_1$	50	ns min	SCLK cycle time
$t_2$	17	ns min	SCLK high time
$t_3$	17	ns min	SCLK low time
$t_4$	20	ns min	$\overline{SYNC}$ falling edge to SCLK falling edge setup time
$t_5$	15	ns min	24 <sup>th</sup> /32 <sup>nd</sup> SCLK falling edge to $\overline{SYNC}$ rising edge (see Figure 79)
$t_6$	2	$\mu\text{s}$ min	$\overline{SYNC}$ high time following a configuration write
	5	$\mu\text{s}$ min	$\overline{SYNC}$ high time following a DAC update write
	20	$\mu\text{s}$ min	$\overline{SYNC}$ high time following a DAC update write (slew rate control enabled)
$t_7$	15	ns min	Data setup time
$t_8$	10	ns min	Data hold time
$t_9$	20	$\mu\text{s}$ min	$\overline{SYNC}$ rising edge to $\overline{LDAC}$ falling edge (applies to any channel with digital slew rate control enabled; single DAC updated)
	5	$\mu\text{s}$ min	$\overline{SYNC}$ rising edge to $\overline{LDAC}$ falling edge (applies to any channel with digital slew rate control disabled; single DAC updated)
$t_{10}$	10	ns min	$\overline{LDAC}$ pulse width low
$t_{11}$	520	ns max	$\overline{LDAC}$ falling edge to DAC output response time
$t_{12}$	See the AC Performance Characteristics section	$\mu\text{s}$ max	DAC output settling time
$t_{13}$	5	$\mu\text{s}$ min	CLEAR high time
$t_{14}$	9	$\mu\text{s}$ max	CLEAR activation time
$t_{15}$	45	ns max	SCLK rising edge to SDO valid
$t_{16}$	5	$\mu\text{s}$ min	$\overline{SYNC}$ rising edge to DAC output response time ( $\overline{LDAC} = 0$ ) (single DAC updated)
$t_{17}$	500	ns min	$\overline{LDAC}$ falling edge to $\overline{SYNC}$ rising edge
$t_{18}$	1	$\mu\text{s}$ min	$\overline{RESET}$ pulse width

<sup>1</sup> Guaranteed by design and characterization; not production tested.

<sup>2</sup> All input signals are specified with  $t_R = t_F = 5\text{ ns}$  (10% to 90% of  $DV_{DD}$ ) and timed from a voltage level of 1.2 V.

<sup>3</sup> See Figure 3, Figure 4, Figure 6, and Figure 7.

Timing Diagrams

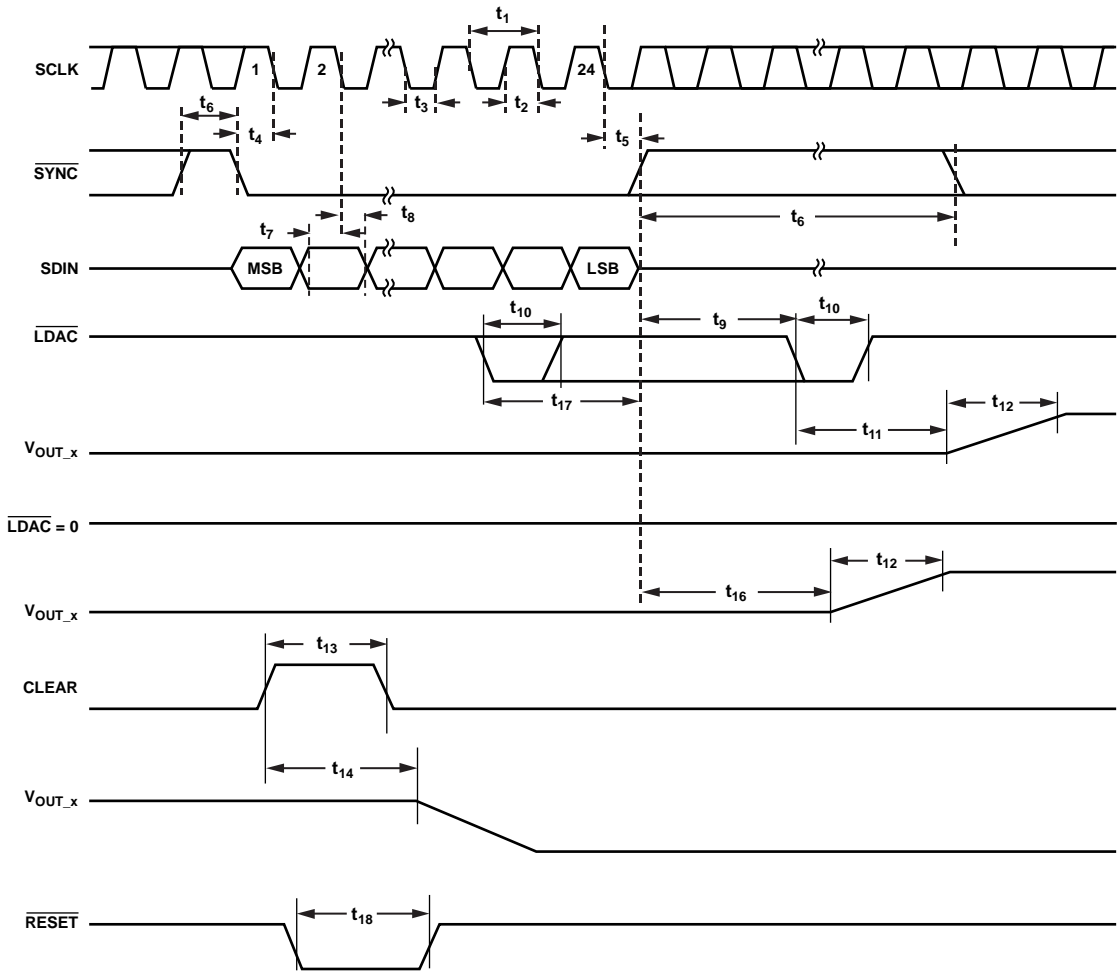

Figure 3. Serial Interface Timing Diagram

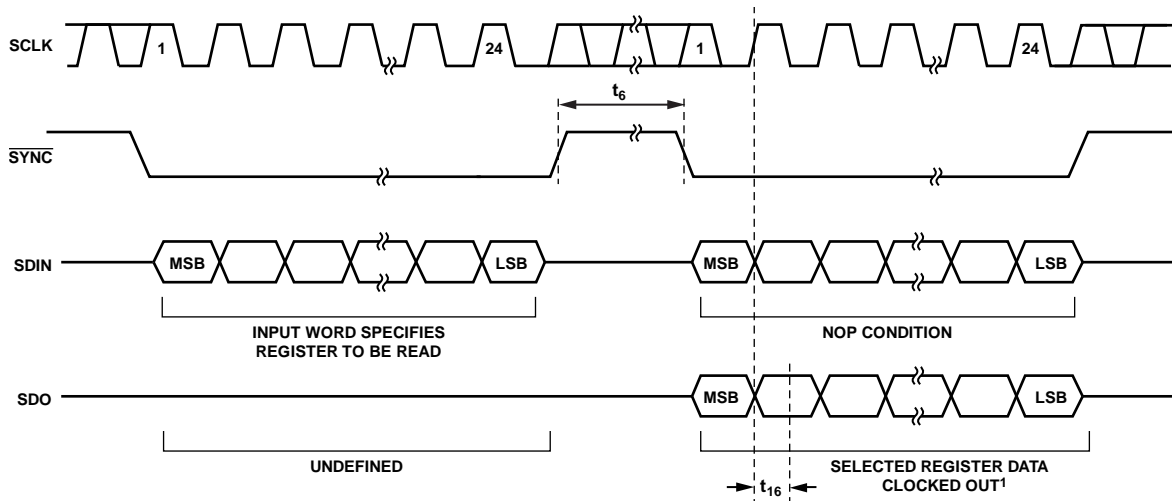
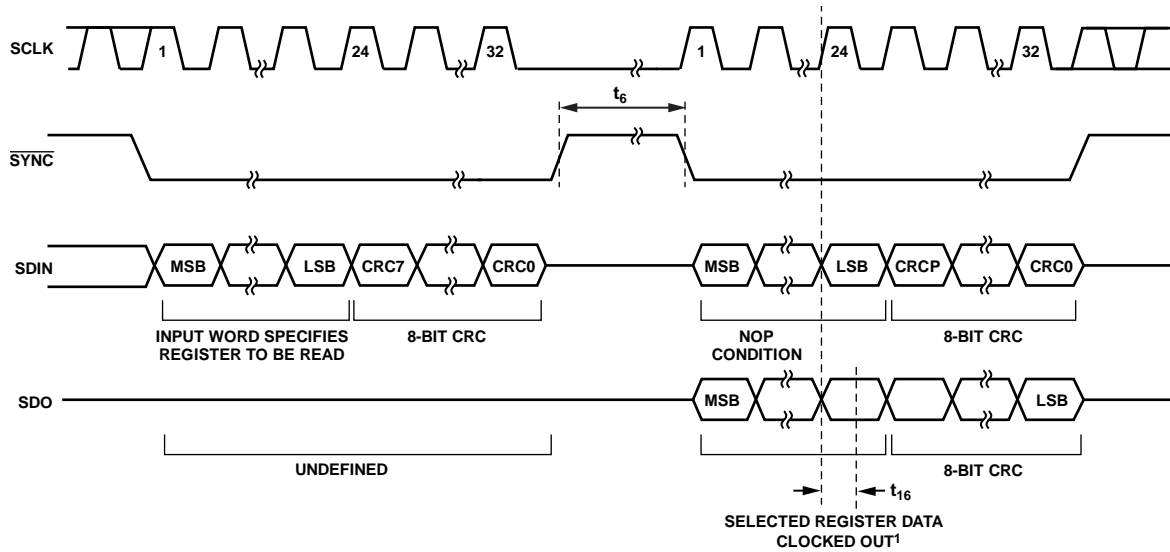
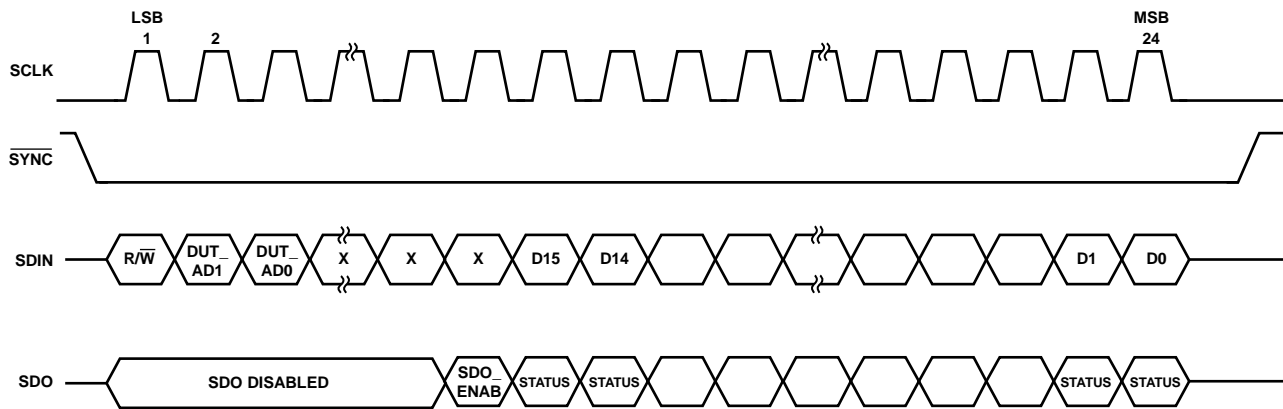

Figure 4. Readback Timing Diagram (Packet Error Checking Disabled)



08226-004



08226-004

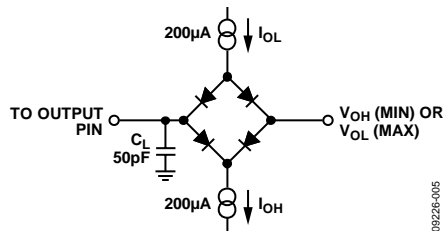

08226-005

## ABSOLUTE MAXIMUM RATINGS

$T_A = 25^\circ\text{C}$ , unless otherwise noted. Transient currents of up to 100 mA do not cause SCR latch-up.

**Table 4.**

Parameter	Rating
$AV_{DD}$ , $V_{BOOST\_x}$ to AGND, DGND	-0.3 V to +33 V
$AV_{SS}$ to AGND, DGND	+0.3 V to -28 V
$AV_{DD}$ to $AV_{SS}$	-0.3 V to +60 V
$AV_{CC}$ to AGND	-0.3 V to +7 V
$DV_{DD}$ to DGND	-0.3 V to +7 V
Digital Inputs to DGND	-0.3 V to $DV_{DD} + 0.3\text{ V}$ or +7 V (whichever is less)
Digital Outputs to DGND	-0.3 V to $DV_{DD} + 0.3\text{ V}$ or +7 V (whichever is less)
REFIN, REFOUT to AGND	-0.3 V to $AV_{DD} + 0.3\text{ V}$ or +7 V (whichever is less)
$V_{OUT\_x}$ to AGND	$AV_{SS}$ to $V_{BOOST\_x}$ or 33 V if using the dc-to-dc circuitry
+ $V_{SENSE\_x}$ to AGND	$AV_{SS}$ to $V_{BOOST\_x}$ or 33 V if using the dc-to-dc circuitry
$I_{OUT\_x}$ to AGND	$AV_{SS}$ to $V_{BOOST\_x}$ or 33 V if using the dc-to-dc circuitry
$SW_x$ to AGND	-0.3 to +33 V
AGND, $GNDSW_x$ to DGND	-0.3 V to +0.3 V
Operating Temperature Range ( $T_A$ )	
Industrial <sup>1</sup>	-40°C to +105°C
Storage Temperature Range	-65°C to +150°C
Junction Temperature ( $T_J$ max)	125°C
64-Lead LFCSP	
$\theta_{JA}$ Thermal Impedance <sup>2</sup>	28°C/W
Power Dissipation	$(T_J \text{ max} - T_A)/\theta_{JA}$
Lead Temperature	JEDEC industry standard
Soldering	J-STD-020

<sup>1</sup> Power dissipated on chip must be derated to keep the junction temperature below 125°C.

<sup>2</sup> Based on a JEDEC 4-layer test board.

Stresses above those listed under Absolute Maximum Ratings may cause permanent damage to the device. This is a stress rating only; functional operation of the device at these or any other conditions above those indicated in the operational section of this specification is not implied. Exposure to absolute maximum rating conditions for extended periods may affect device reliability.

### ESD CAUTION



#### ESD (electrostatic discharge) sensitive device.

Charged devices and circuit boards can discharge without detection. Although this product features patented or proprietary protection circuitry, damage may occur on devices subjected to high energy ESD. Therefore, proper ESD precautions should be taken to avoid performance degradation or loss of functionality.

# PIN CONFIGURATION AND FUNCTION DESCRIPTIONS

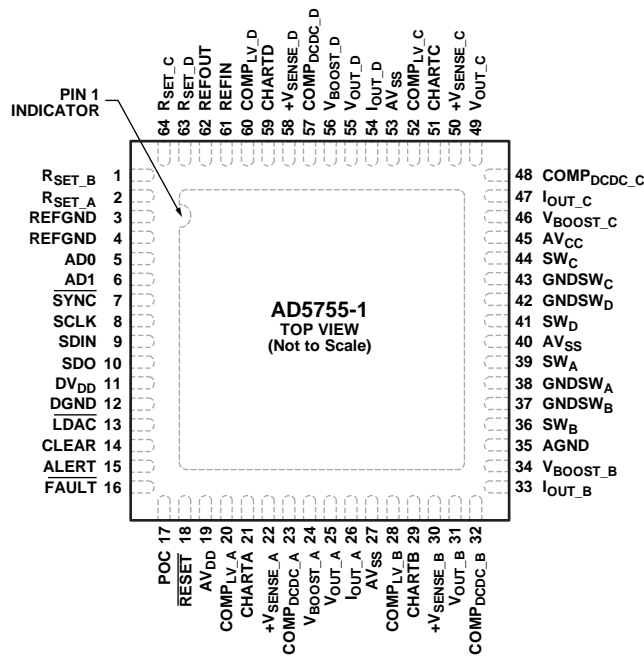

**NOTES**  
 1. THE EXPOSED PAD SHOULD BE CONNECTED TO THE POTENTIAL OF THE AV<sub>SS</sub> PIN, OR, ALTERNATIVELY, IT CAN BE LEFT ELECTRICALLY UNCONNECTED. IT IS RECOMMENDED THAT THE PAD BE THERMALLY CONNECTED TO A COPPER PLANE FOR ENHANCED THERMAL PERFORMANCE.

Figure 8. Pin Configuration

Table 5. Pin Function Descriptions

Pin No.	Mnemonic	Description
1	R <sub>SET_B</sub>	An external, precision, low drift 15 kΩ current setting resistor can be connected to this pin to improve the I <sub>OUT_B</sub> temperature drift performance. See the Device Features section.
2	R <sub>SET_A</sub>	An external, precision, low drift 15 kΩ current setting resistor can be connected to this pin to improve the I <sub>OUT_A</sub> temperature drift performance. See the Device Features section.
3, 4	REFGND	Ground Reference Point for Internal Reference.
5	AD0	Address Decode for the Device Under Test (DUT) on the Board.
6	AD1	Address Decode for the DUT on the Board. It is not recommended to tie both AD1 and AD0 low when using PEC, see the Packet Error Checking section.
7	<u>SYNC</u>	Active Low Input. This is the frame synchronization signal for the serial interface. While <u>SYNC</u> is low, data is transferred in on the falling edge of SCLK.
8	SCLK	Serial Clock Input. Data is clocked into the input shift register on the falling edge of SCLK. This operates at clock speeds of up to 30 MHz.
9	SDIN	Serial Data Input. Data must be valid on the falling edge of SCLK.
10	SDO	Serial Data Output. Used to clock data from the serial register in readback mode. See Figure 4 and Figure 6.
11	DV <sub>DD</sub>	Digital Supply. The voltage range is from 2.7 V to 5.5 V.
12	<u>DGND</u>	Digital Ground.
13	<u>LDAC</u>	Load DAC, Active Low Input. This is used to update the DAC register and consequently the DAC outputs. When tied permanently low, the addressed DAC data register is updated on the rising edge of <u>SYNC</u> . If <u>LDAC</u> is held high during the write cycle, the DAC input register is updated, but the DAC output update only takes place at the falling edge of <u>LDAC</u> (see Figure 3). Using this mode, all analog outputs can be updated simultaneously. The <u>LDAC</u> pin must not be left unconnected.

Pin No.	Mnemonic	Description
14	CLEAR	Active High, Edge Sensitive Input. Asserting this pin sets the output current and voltage to the preprogrammed clear code bit setting. Only channels enabled to be cleared are cleared. See the Device Features section for more information. When CLEAR is active, the DAC output register cannot be written to.
15	ALERT	Active High Output. This pin is asserted when there has been no SPI activity on the interface pins for a predetermined time. See the Device Features section for more information.
16	FAULT	Active Low Output. This pin is asserted low when an open circuit in current mode is detected, a short circuit in voltage mode is detected, a PEC error is detected, or an overtemperature is detected (see the Device Features section). Open-drain output.
17	POC	Power-On Condition. This pin determines the power-on condition and is read during power-on or, alternatively, after a device reset. If POC = 0, the device is powered up with the voltage and current channels in tristate mode. If POC = 1, the device is powered up with a 30 k $\Omega$ pull-down resistor to ground on the voltage output channel, and the current channel is in tristate mode.
18	RESET	Hardware Reset, Active Low Input.
19	AV <sub>DD</sub>	Positive Analog Supply. The voltage range is from 9 V to 33 V.
20	COMP <sub>LV_A</sub>	Optional Compensation Capacitor Connection for V <sub>OUT_A</sub> Output Buffer. Connecting a 220 pF capacitor between this pin and the V <sub>OUT_A</sub> pin allows the voltage output to drive up to 2 $\mu$ F. Note that the addition of this capacitor reduces the bandwidth of the output amplifier, increasing the settling time.
21	CHARTA	HART Input Connection for DAC Channel A. For more information, see the HART Connectivity section. If unused, leave as an open circuit.
22	+V <sub>SENSE_A</sub>	Sense Connection for the Positive Voltage Output Load Connection for V <sub>OUT_A</sub> .
23	COMP <sub>DCDC_A</sub>	DC-to-DC Compensation Capacitor. Connect a 10 nF capacitor from this pin to ground. Used to regulate the feedback loop of the Channel A dc-to-dc converter. Alternatively, if using an external compensation resistor, place a resistor in series with a capacitor to ground from this pin (see the DC-to-DC Converter Compensation Capacitors and the I <sub>CC</sub> Supply Requirements—Slewing sections in the Device Features section for more information).
24	V <sub>BOOST_A</sub>	Supply for Channel A Current Output Stage (see Figure 74). This is also the supply for the V <sub>OUT_x</sub> stage, which is regulated to 15 V by the dc-to-dc converter. To use the dc-to-dc feature of the device, connect as shown in Figure 81.
25	V <sub>OUT_A</sub>	Buffered Analog Output Voltage for DAC Channel A.
26	I <sub>OUT_A</sub>	Current Output Pin for DAC Channel A.
27	AV <sub>SS</sub>	Negative Analog Supply. Voltage range is from 0 V to –26.4 V.
28	COMP <sub>LV_B</sub>	Optional Compensation Capacitor Connection for V <sub>OUT_B</sub> Output Buffer. Connecting a 220 pF capacitor between this pin and the V <sub>OUT_B</sub> pin allows the voltage output to drive up to 2 $\mu$ F. Note that the addition of this capacitor reduces the bandwidth of the output amplifier, increasing the settling time.
29	CHARTB	HART Input Connection for DAC Channel B. For more information, see the HART Connectivity section. If unused, leave as an open circuit.
30	+V <sub>SENSE_B</sub>	Sense Connection for the Positive Voltage Output Load Connection for V <sub>OUT_B</sub> .
31	V <sub>OUT_B</sub>	Buffered Analog Output Voltage for DAC Channel B.
32	COMP <sub>DCDC_B</sub>	DC-to-DC Compensation Capacitor. Connect a 10 nF capacitor from this pin to ground. Used to regulate the feedback loop of the Channel B dc-to-dc converter. Alternatively, if using an external compensation resistor, place a resistor in series with a capacitor to ground from this pin (see the DC-to-DC Converter Compensation Capacitors and I <sub>CC</sub> Supply Requirements—Slewing sections in the Device Features section for more information).
33	I <sub>OUT_B</sub>	Current Output Pin for DAC Channel B.
34	V <sub>BOOST_B</sub>	Supply for Channel B Current Output Stage (see Figure 74). This is also the supply for the V <sub>OUT_x</sub> stage, which is regulated to 15 V by the dc-to-dc converter. To use the dc-to-dc feature of the device, connect as shown in Figure 81.
35	AGND	Ground Reference Point for Analog Circuitry. This must be connected to 0 V.
36	SW <sub>B</sub>	Switching Output for Channel B DC-to-DC Circuitry. To use the dc-to-dc feature of the device, connect as shown in Figure 81.
37	GND <sub>SW_B</sub>	Ground Connection for DC-to-DC Switching Circuit. This pin must always be connected to ground.
38	GND <sub>SW_A</sub>	Ground Connection for DC-to-DC Switching Circuit. This pin must always be connected to ground.
39	SW <sub>A</sub>	Switching Output for Channel A DC-to-DC Circuitry. To use the dc-to-dc feature of the device, connect as shown in Figure 81.
40	AV <sub>SS</sub>	Negative Analog Supply Pin. The voltage range is from –10.8 V to –26.4 V. This pin can be connected to 0 V if using the device in unipolar supply mode.

Pin No.	Mnemonic	Description
41	SW <sub>D</sub>	Switching Output for Channel D DC-DC Circuitry. To use the dc-to-dc feature of the device, connect as shown in Figure 81.
42	GNDSW <sub>D</sub>	Ground Connections for DC-to-DC Switching Circuit. This pin must always be connected to ground.
43	GNDSW <sub>C</sub>	Ground Connections for DC-to-DC Switching Circuit. This pin must always be connected to ground.
44	SW <sub>C</sub>	Switching Output for Channel C DC-to-DC Circuitry. To use the dc-to-dc feature of the device, connect as shown in Figure 81.
45	AV <sub>CC</sub>	Supply for DC-to-DC Circuitry.
46	V <sub>BOOST_C</sub>	Supply for Channel C Current Output Stage (see Figure 74). This is also the supply for the V <sub>OUT_x</sub> stage, which is regulated to 15 V by the dc-to-dc converter. To use the dc-to-dc feature of the device, connect as shown in Figure 81.
47	I <sub>OUT_C</sub>	Current Output Pin for DAC Channel C.
48	COMP <sub>DCDC_C</sub>	DC-to-DC Compensation Capacitor. Connect a 10 nF capacitor from this pin to ground. Used to regulate the feedback loop of the Channel C dc-to-dc converter. Alternatively, if using an external compensation resistor, place a resistor in series with a capacitor to ground from this pin (see the DC-to-DC Converter Compensation Capacitors and AICC Supply Requirements—Slewing sections in the Device Features section for more information).
49	V <sub>OUT_C</sub>	Buffered Analog Output Voltage for DAC Channel C.
50	+V <sub>SENSE_C</sub>	Sense Connection for the Positive Voltage Output Load Connection for V <sub>OUT_C</sub> .
51	CHARTC	HART Input Connection for DAC Channel C. For more information, see the HART Connectivity section. If unused, leave as an open circuit.
52	COMP <sub>LV_C</sub>	Optional Compensation Capacitor Connection for V <sub>OUT_C</sub> Output Buffer. Connecting a 220 pF capacitor between this pin and the V <sub>OUT_C</sub> pin allows the voltage output to drive up to 2 μF. Note that the addition of this capacitor reduces the bandwidth of the output amplifier, increasing the settling time.
53	AV <sub>SS</sub>	Negative Analog Supply Pin.
54	I <sub>OUT_D</sub>	Current Output Pin for DAC Channel D.
55	V <sub>OUT_D</sub>	Buffered Analog Output Voltage for DAC Channel D.
56	V <sub>BOOST_D</sub>	Supply for Channel D Current Output Stage (see Figure 74). This is also the supply for the V <sub>OUT_x</sub> stage, which is regulated to 15 V by the dc-to-dc converter. To use the dc-to-dc feature of the device, connect as shown in Figure 81.
57	COMP <sub>DCDC_D</sub>	DC-to-DC Compensation Capacitor. Connect a 10 nF capacitor from this pin to ground. Used to regulate the feedback loop of the Channel D dc-to-dc converter. Alternatively, if using an external compensation resistor, place a resistor in series with a capacitor to ground from this pin (see the DC-to-DC Converter Compensation Capacitors and AICC Supply Requirements—Slewing sections in the Device Features section for more information).
58	+V <sub>SENSE_D</sub>	Sense Connection for the Positive Voltage Output Load Connection for V <sub>OUT_D</sub> .
59	CHARTD	HART Input Connection for DAC Channel D. For more information, see the HART Connectivity section. If unused, leave as an open circuit.
60	COMP <sub>LV_D</sub>	Optional Compensation Capacitor Connection for V <sub>OUT_D</sub> Output Buffer. Connecting a 220 pF capacitor between this pin and the V <sub>OUT_D</sub> pin allows the voltage output to drive up to 2 μF. Note that the addition of this capacitor reduces the bandwidth of the output amplifier, increasing the settling time.
61	REFIN	External Reference Voltage Input.
62	REFOUT	Internal Reference Voltage Output. Place a 0.1 μF capacitor between REFOUT and REFGND. REFOUT must be connected to REFIN to use the internal reference.
63	R <sub>SET_D</sub>	An external, precision, low drift 15 kΩ current setting resistor can be connected to this pin to improve the I <sub>OUT_D</sub> temperature drift performance. See the Device Features section.
64	R <sub>SET_C</sub>	An external, precision, low drift 15 kΩ current setting resistor can be connected to this pin to improve the I <sub>OUT_C</sub> temperature drift performance. See the Device Features section.
	EPAD	Exposed Pad. Connect this exposed pad to the potential of the AV <sub>SS</sub> pin, or, alternatively, leave it electrically unconnected. It is recommended that the pad be thermally connected to a copper plane for enhanced thermal performance.

# TYPICAL PERFORMANCE CHARACTERISTICS

## VOLTAGE OUTPUTS

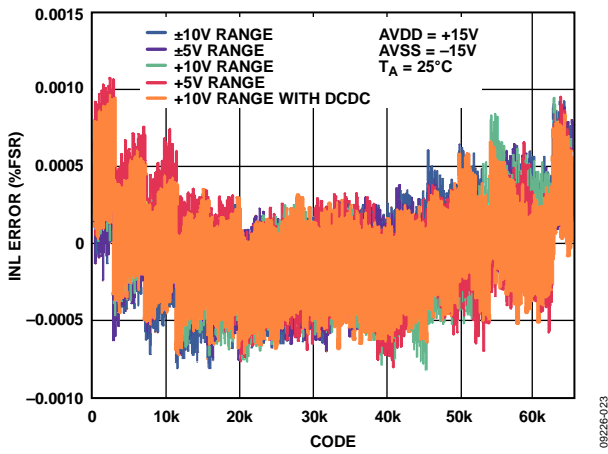

Figure 9. Integral Nonlinearity Error vs. DAC Code

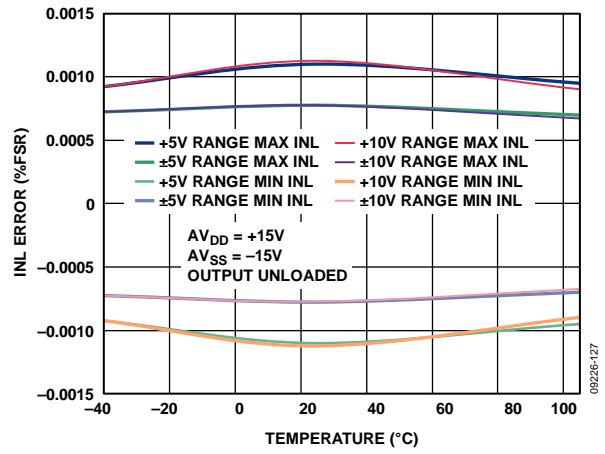

Figure 12. Integral Nonlinearity Error vs. Temperature

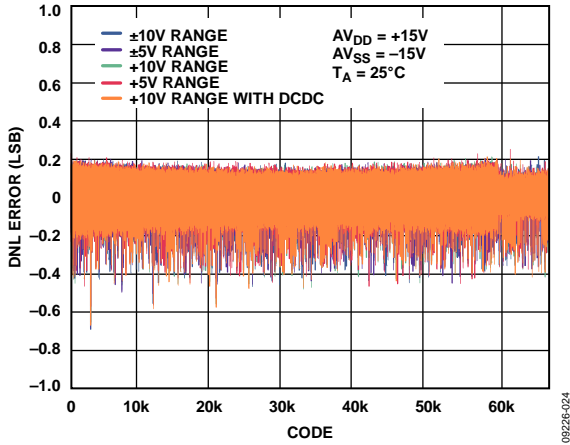

Figure 10. Differential Nonlinearity Error vs. DAC Code

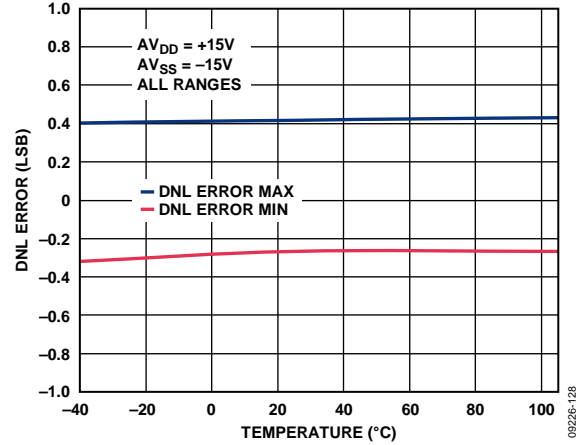

Figure 13. Differential Nonlinearity Error vs. Temperature

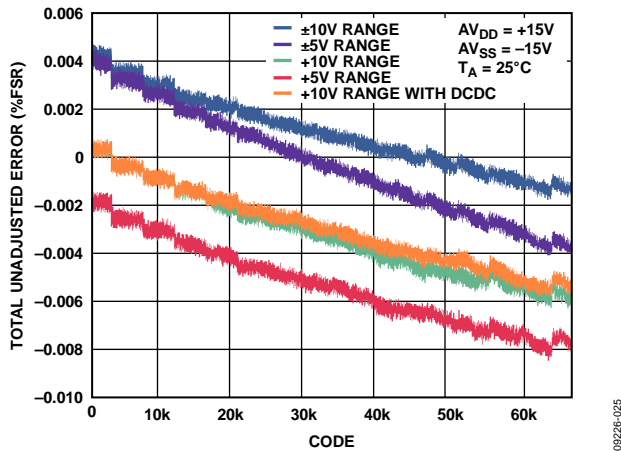

Figure 11. Total Unadjusted Error vs. DAC Code

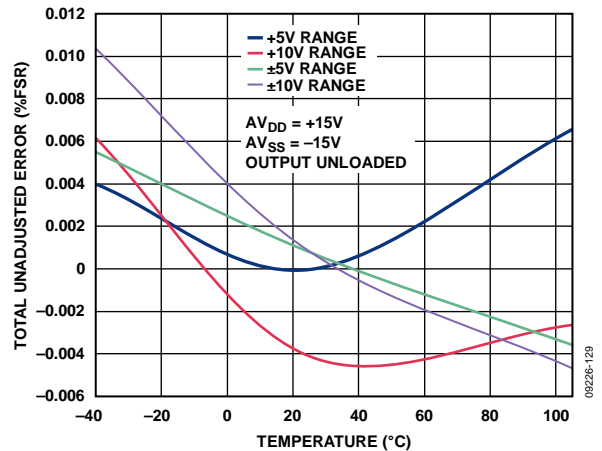

Figure 14. Total Unadjusted Error vs. Temperature



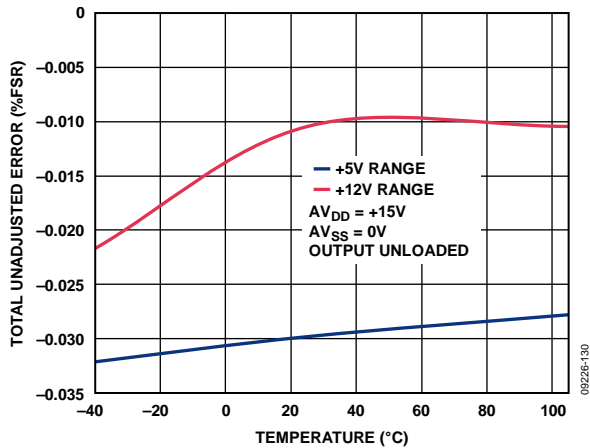

Figure 15. Total Unadjusted Error vs. Temperature, Single Supply

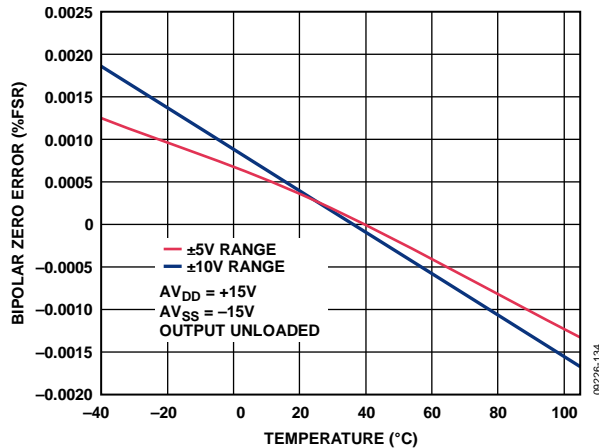

Figure 18. Bipolar Zero Error vs. Temperature

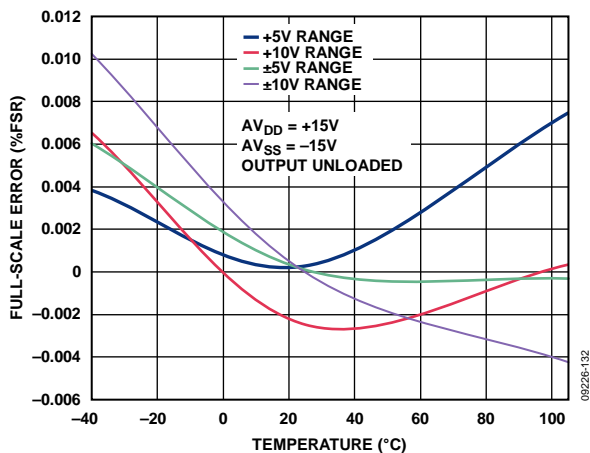

Figure 16. Full-Scale Error vs. Temperature

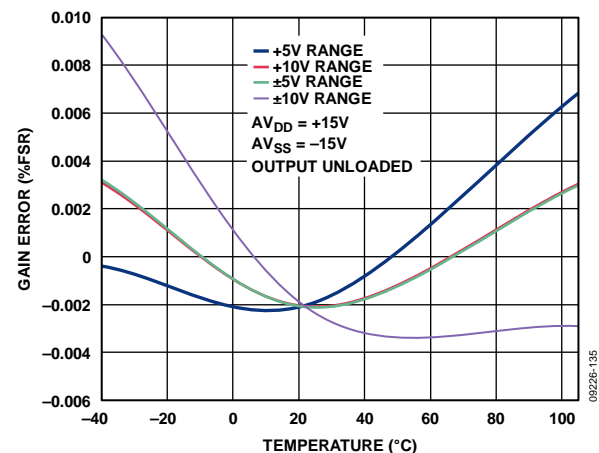

Figure 19. Gain Error vs. Temperature

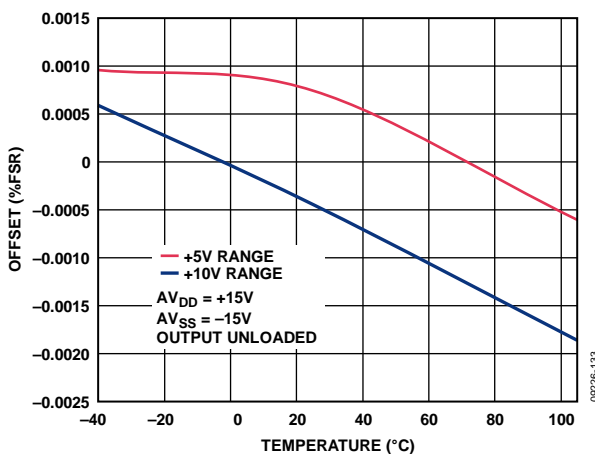

Figure 17. Offset Error vs. Temperature

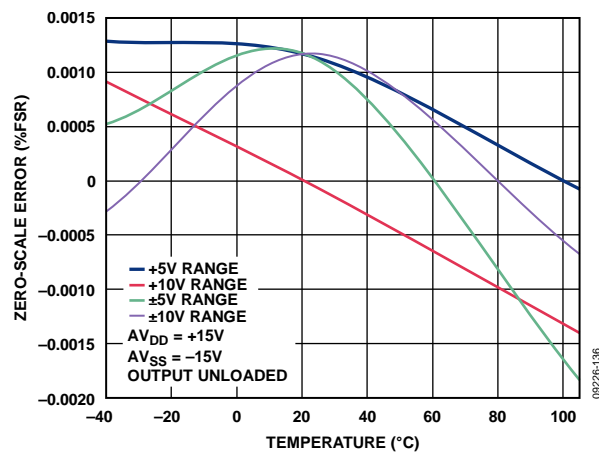

Figure 20. Zero-Scale Error vs. Temperature

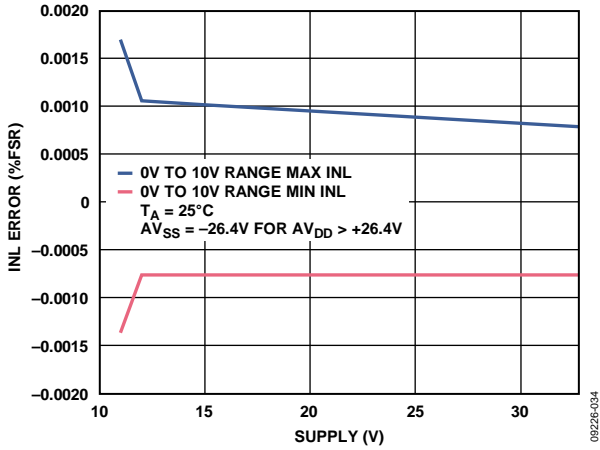

Figure 21. Integral Nonlinearity Error vs. AVDD/AVSS

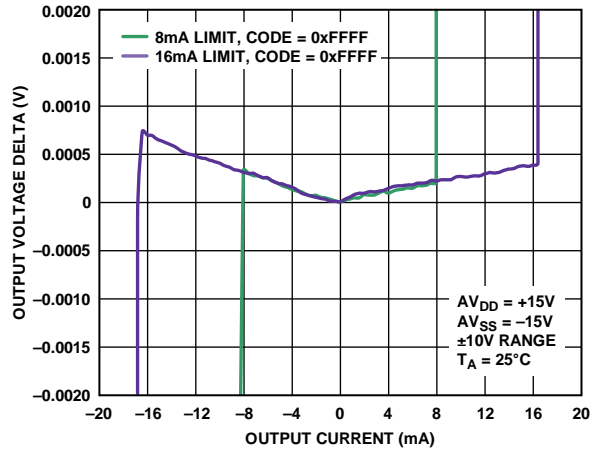

Figure 24. Source and Sink Capability of Output Amplifier

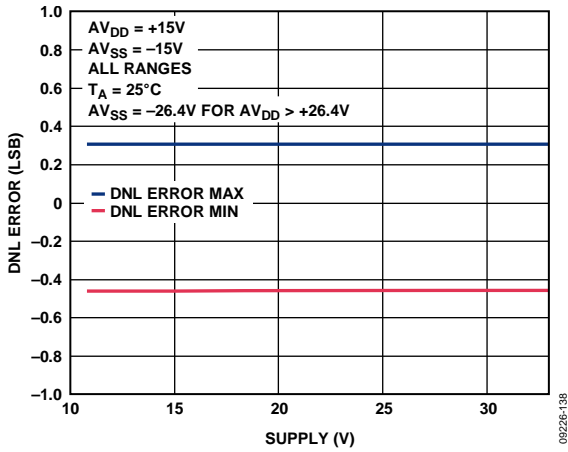

Figure 22. Differential Nonlinearity Error vs. AVDD/AVSS

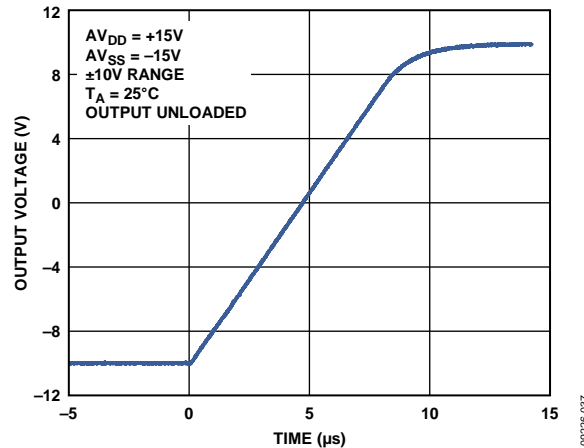

Figure 25. Full-Scale Positive Step

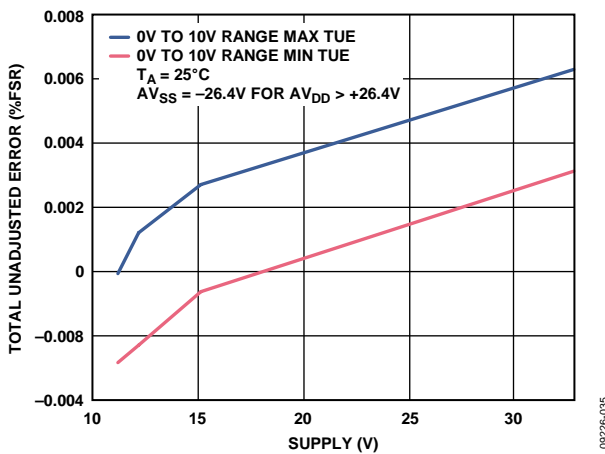

Figure 23. Total Unadjusted Error vs. AVDD/AVSS

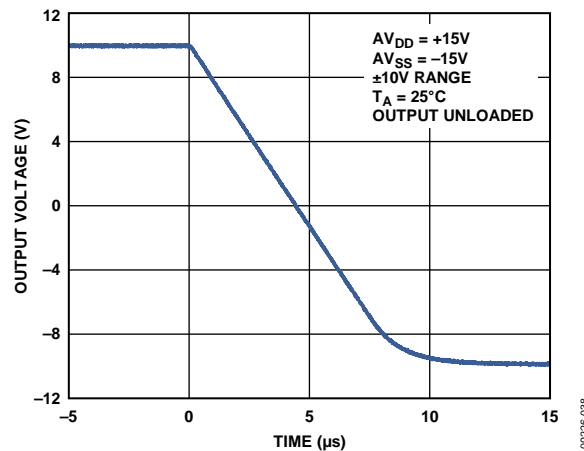

Figure 26. Full-Scale Negative Step

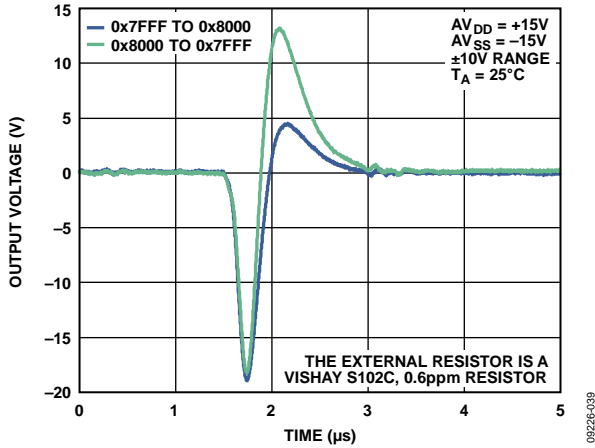

Figure 27. Digital-to-Analog Glitch

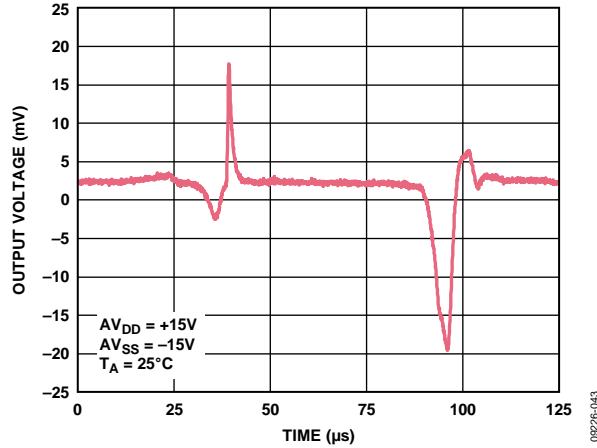

Figure 30.  $V_{OUT\_X}$  vs. Time on Power-Up

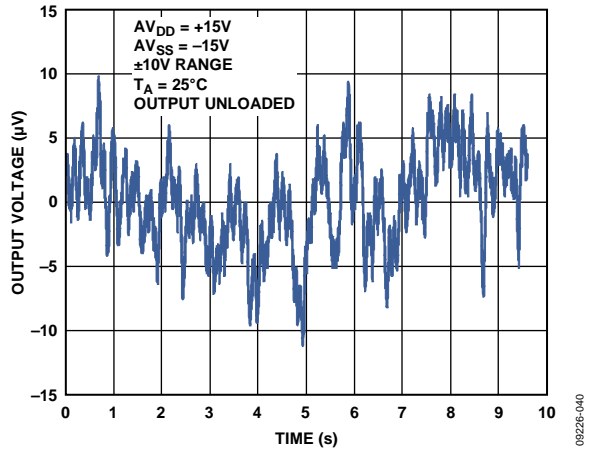

Figure 28. Peak-to-Peak Noise (0.1 Hz to 10 Hz Bandwidth)

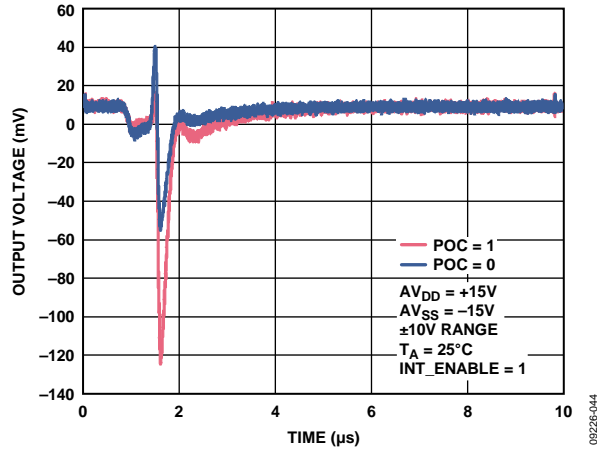

Figure 31.  $V_{OUT\_X}$  vs. Time on Output Enable

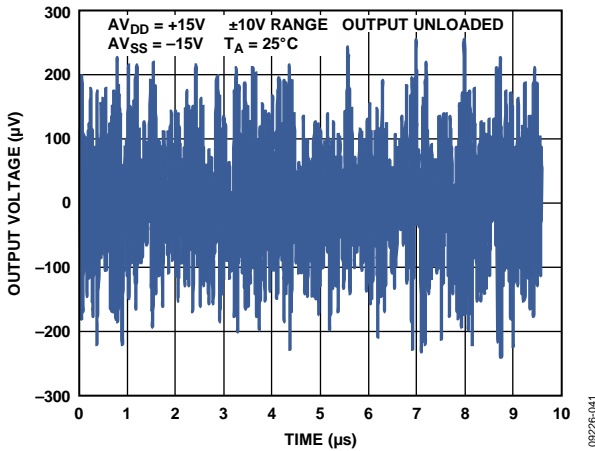

Figure 29. Peak-to-Peak Noise (100 kHz Bandwidth)

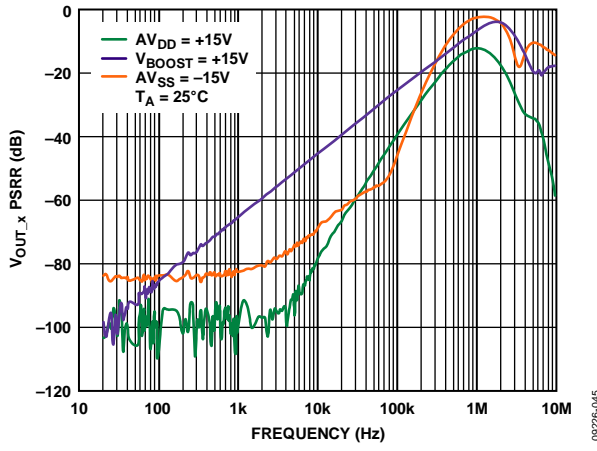

Figure 32.  $V_{OUT\_X}$  PSRR vs. Frequency

CURRENT OUTPUTS

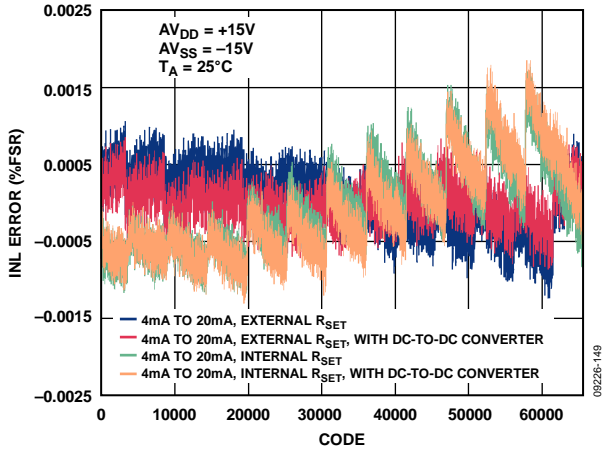

Figure 33. Integral Nonlinearity vs. Code

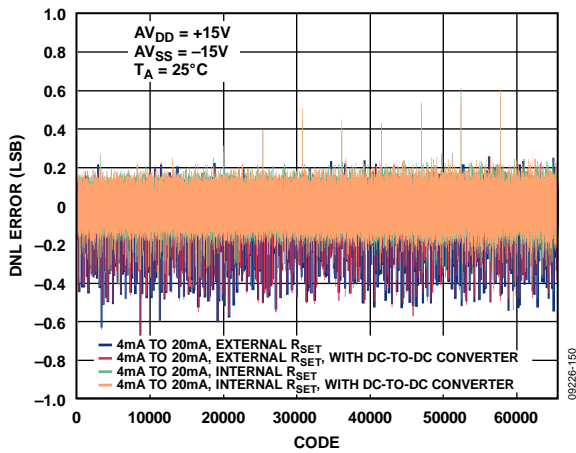

Figure 34. Differential Nonlinearity vs. Code

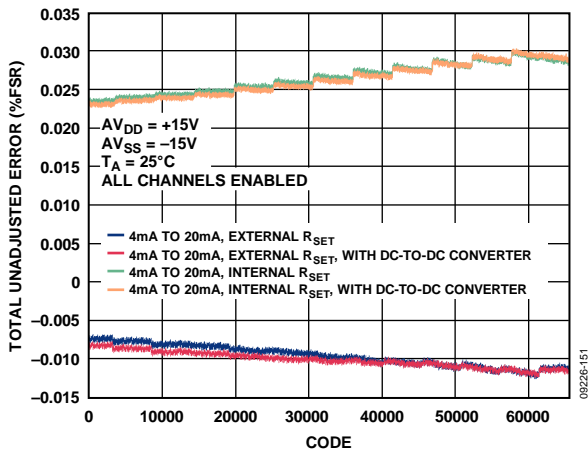

Figure 35. Total Unadjusted Error vs. Code

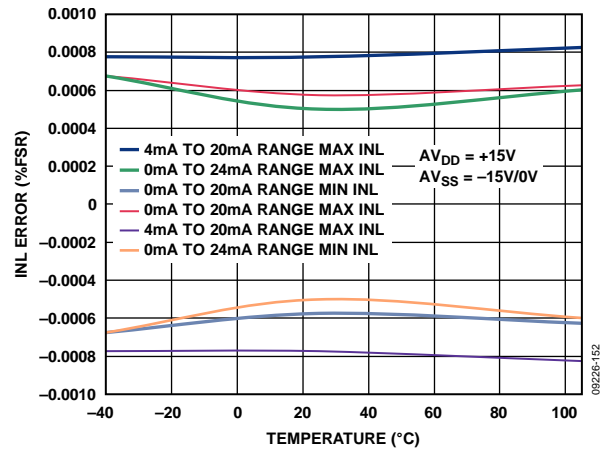

Figure 36. Integral Nonlinearity vs. Temperature, Internal RSET

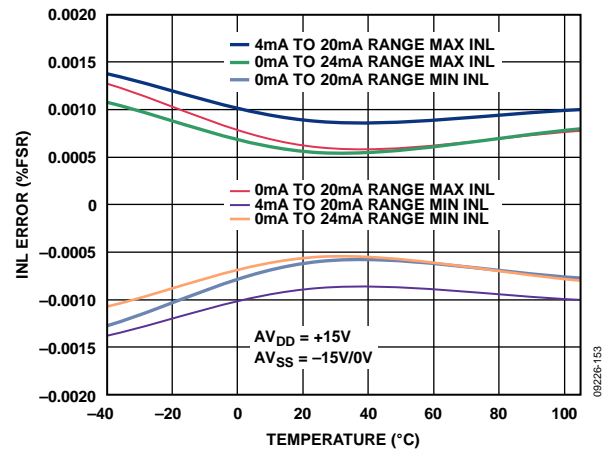

Figure 37. Integral Nonlinearity vs. Temperature, External RSET

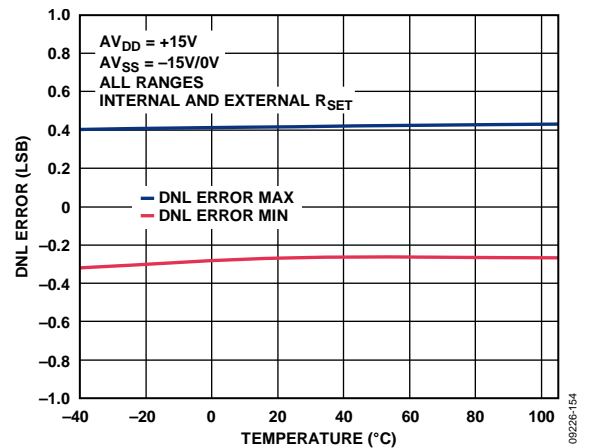

Figure 38. Differential Nonlinearity vs. Temperature

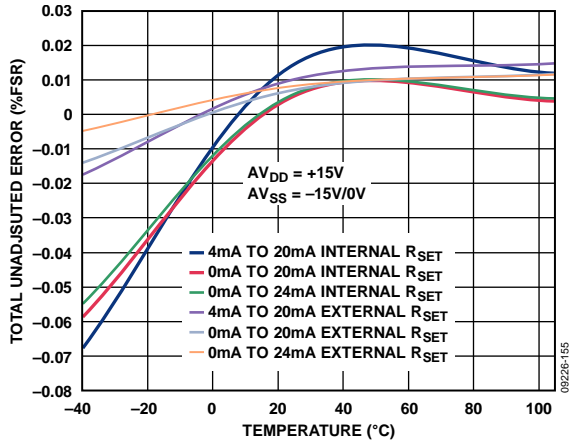

Figure 39. Total Unadjusted Error vs. Temperature

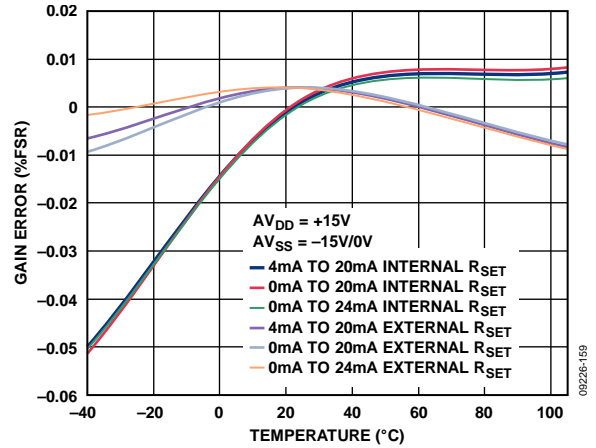

Figure 42. Gain Error vs. Temperature

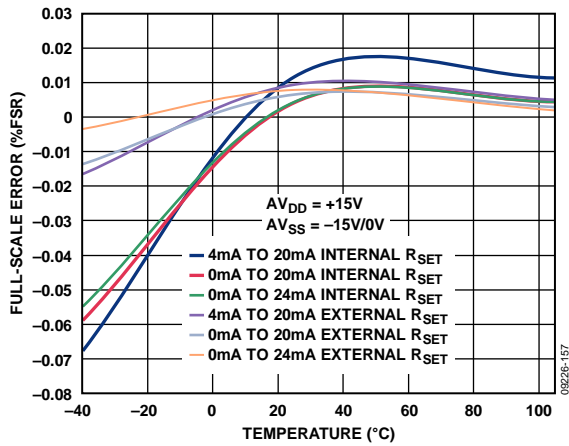

Figure 40. Full Scale Error vs. Temperature

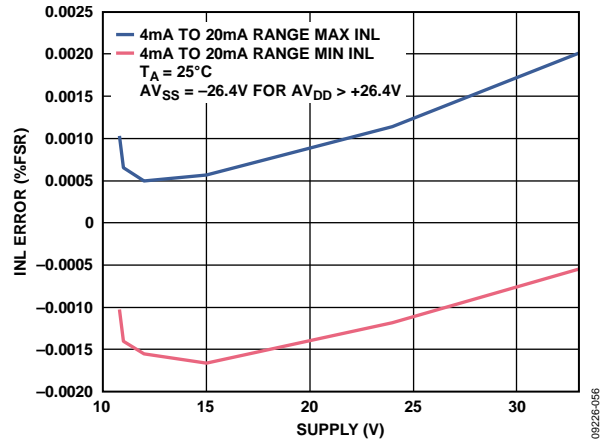

Figure 43. Integral Nonlinearity Error vs.  $AV_{DD}/|AV_{SS}|$ , Over Supply, External RSET

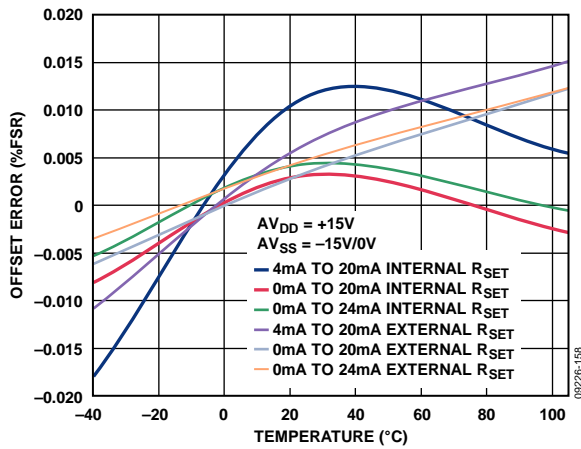

Figure 41. Offset Error vs. Temperature

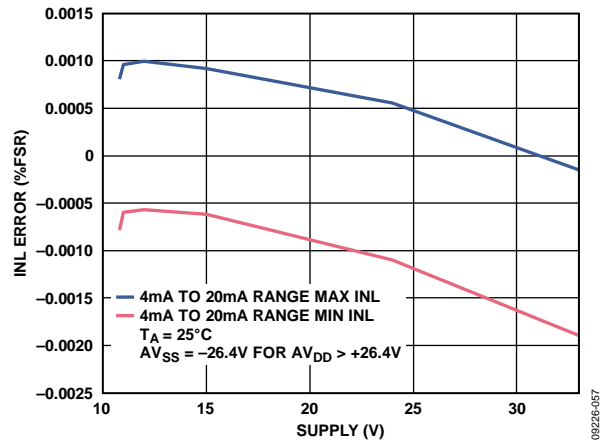

Figure 44. Integral Nonlinearity Error vs.  $AV_{DD}/|AV_{SS}|$ , Over Supply, Internal RSET

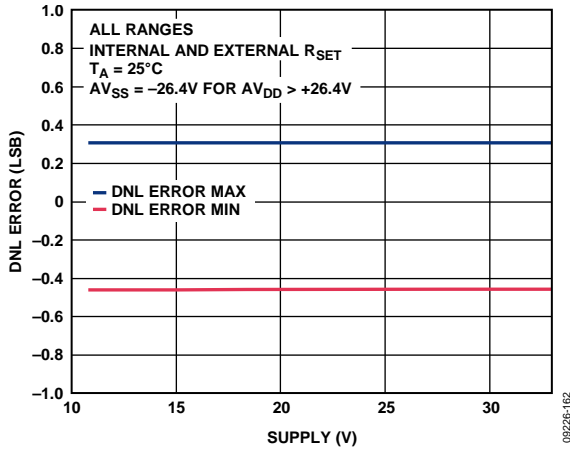

Figure 45. Differential Nonlinearity Error vs.  $AV_{DD}$

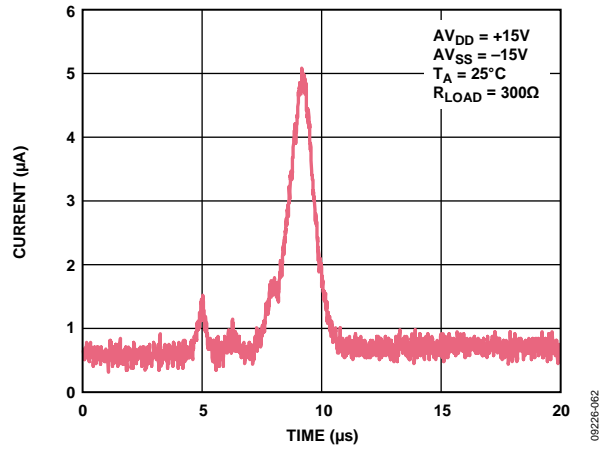

Figure 48. Output Current vs. Time on Power-Up

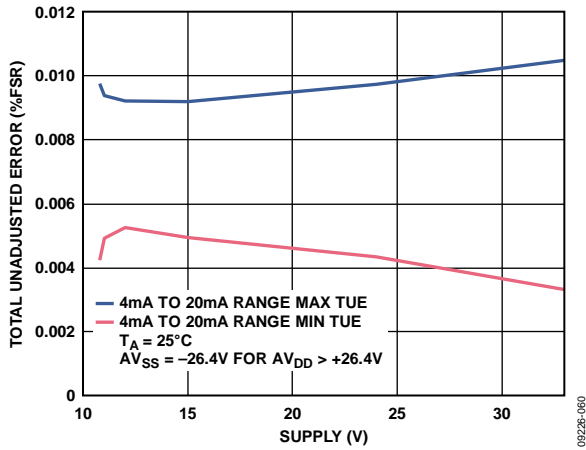

Figure 46. Total Unadjusted Error vs.  $AV_{DD}$ , External  $R_{SET}$

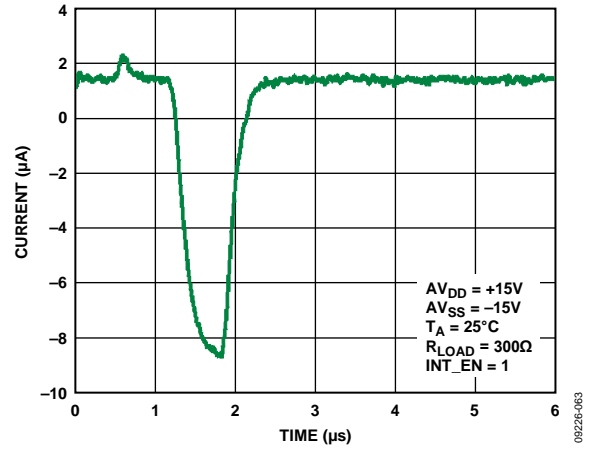

Figure 49. Output Current vs. Time on Output Enable

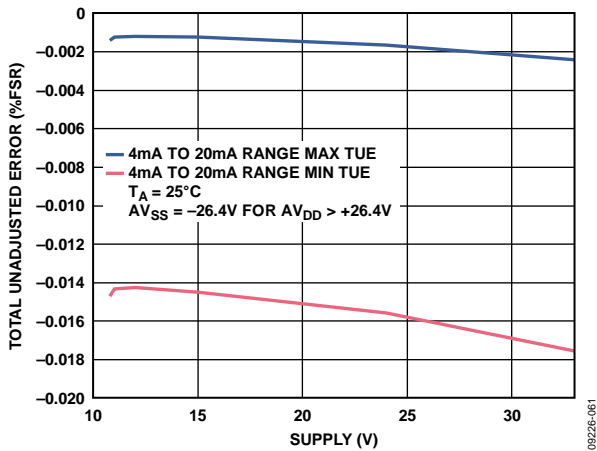

Figure 47. Total Unadjusted Error vs.  $AV_{DD}$ , Internal  $R_{SET}$

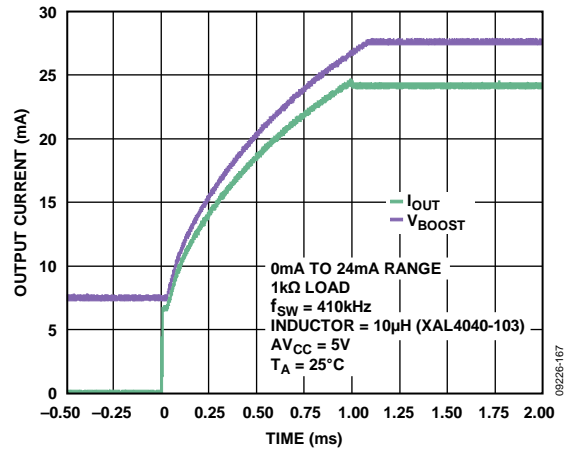

Figure 50. Output Current and  $V_{BOOST,x}$  Settling Time with DC-to-DC Converter (See Figure 81)

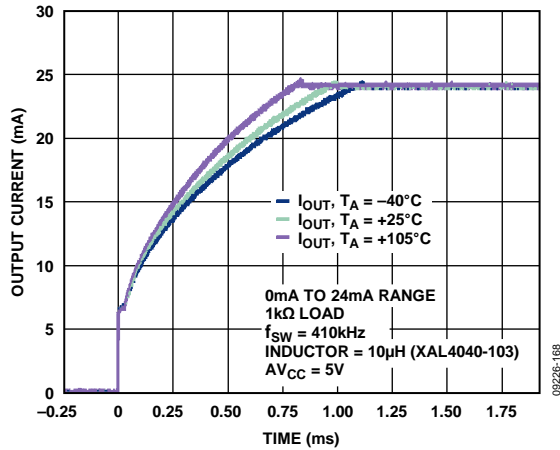

Figure 51. Output Current Settling with DC-to-DC Converter vs. Time and Temperature (See Figure 81)

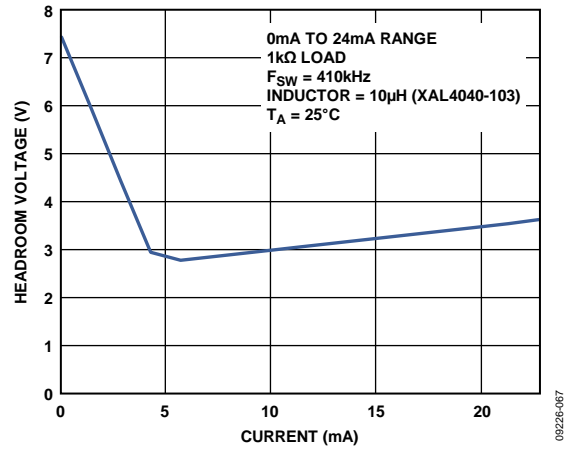

Figure 54. DC-to-DC Converter Headroom vs. Output Current (See Figure 81)

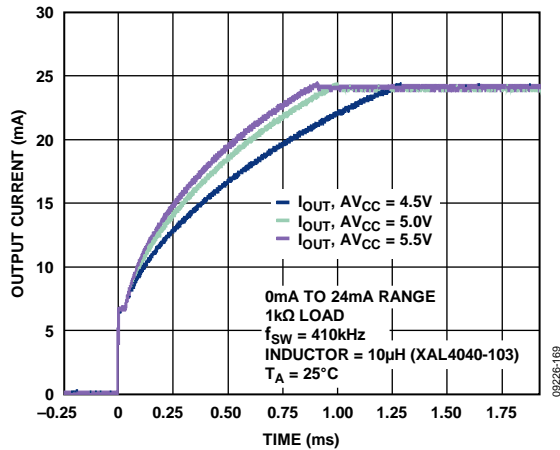

Figure 52. Output Current Settling with DC-to-DC Converter vs. Time and  $A_{V_{CC}}$  (See Figure 81)

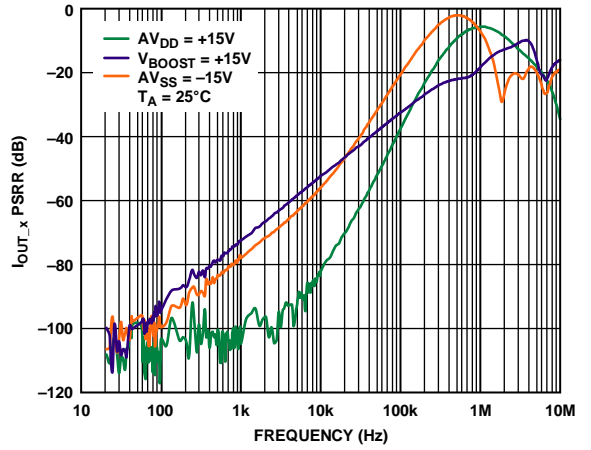

Figure 55.  $I_{OUT,x}$  PSRR vs. Frequency

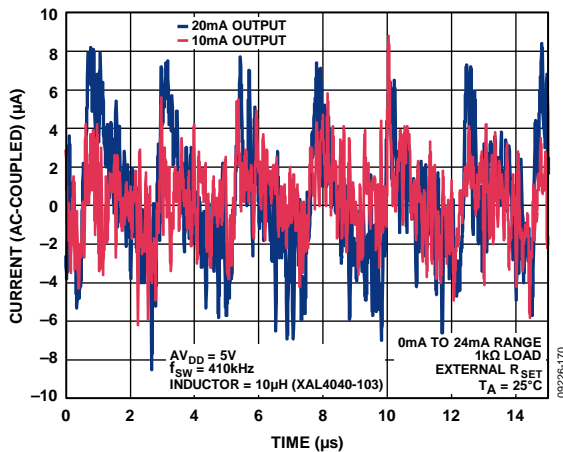

Figure 53. Output Current vs. Time with DC-to-DC Converter (See Figure 81)

DC-TO-DC BLOCK

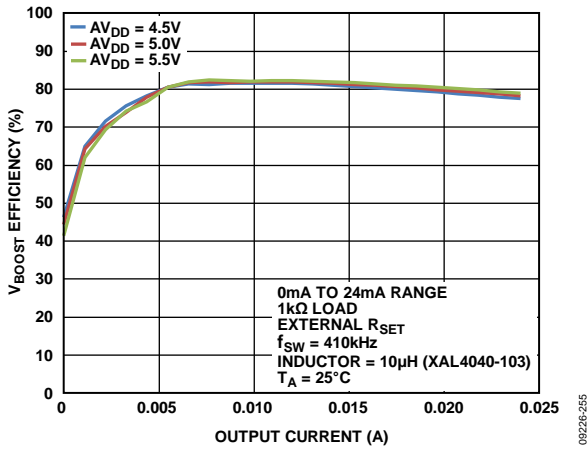

Figure 56. Efficiency at  $V_{BOOST\_X}$  vs. Output Current (See Figure 81)

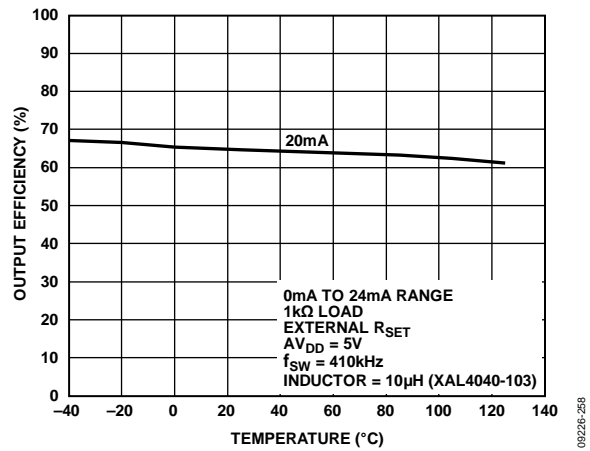

Figure 59. Output Efficiency vs. Temperature (See Figure 81)

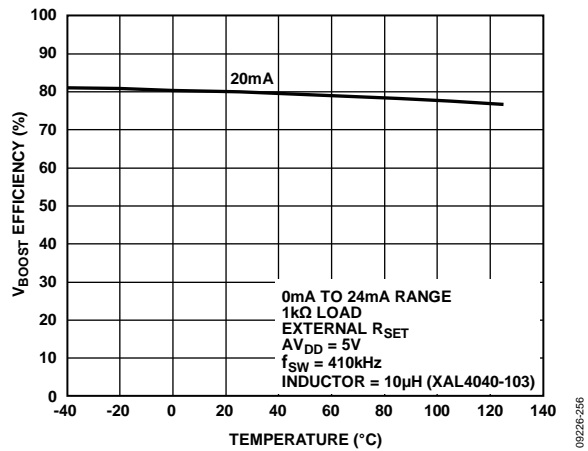

Figure 57. Efficiency at  $V_{BOOST\_X}$  vs. Temperature (See Figure 81)

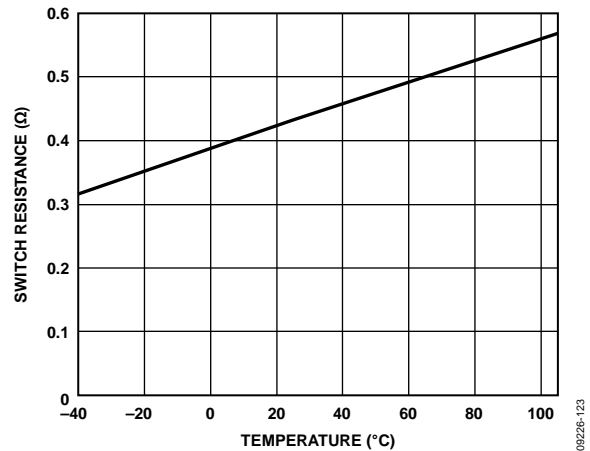

Figure 60. Switch Resistance vs. Temperature

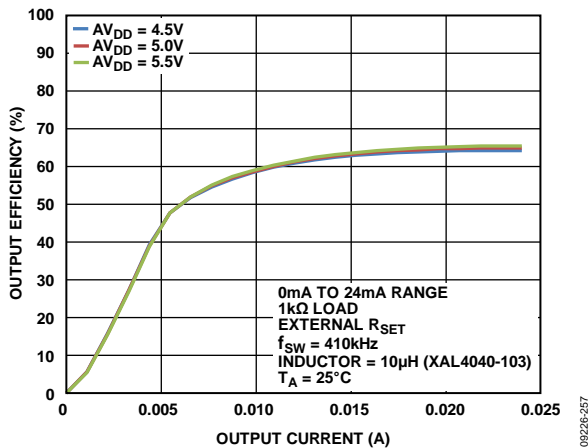

Figure 58. Output Efficiency vs. Output Current (See Figure 81)

09226-256

09226-258

09226-256

09226-123

09226-257



REFERENCE

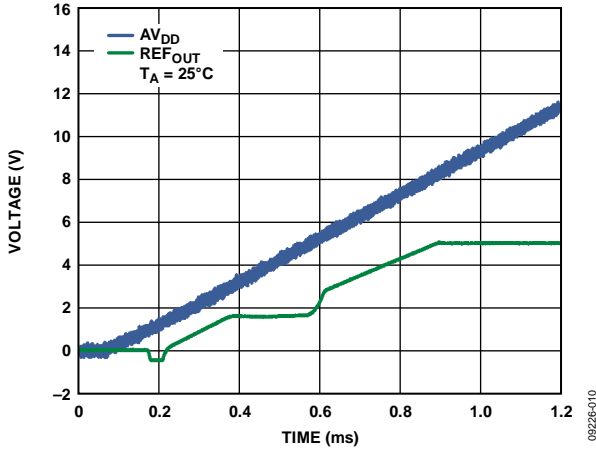

Figure 61. REFOUT Turn-On Transient

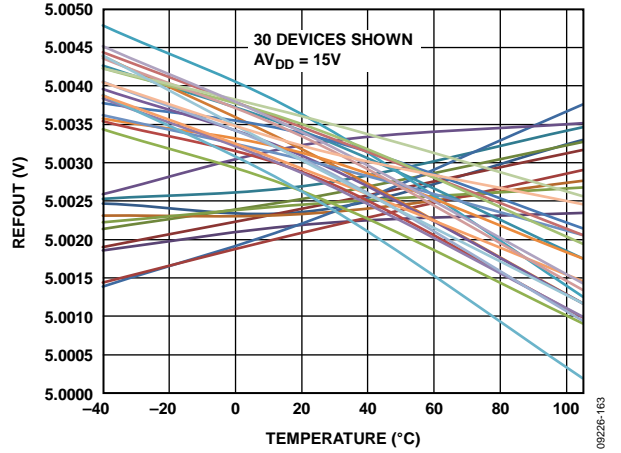

Figure 64. REFOUT vs. Temperature (When the AD5755-1 is soldered onto a PCB, the reference shifts due to thermal shock on the package. The average output voltage shift is  $-4\text{ mV}$ . Measurement of these parts after seven days shows that the outputs typically shift back  $2\text{ mV}$  toward their initial values. This second shift is due to the relaxations of stress incurred during soldering.)

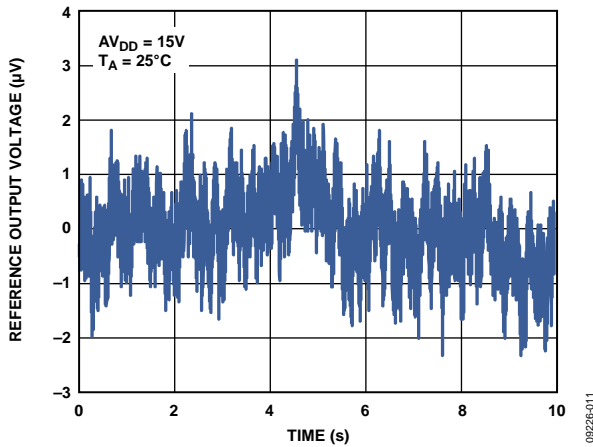

Figure 62. REFOUT Output Noise (0.1 Hz to 10 Hz Bandwidth)

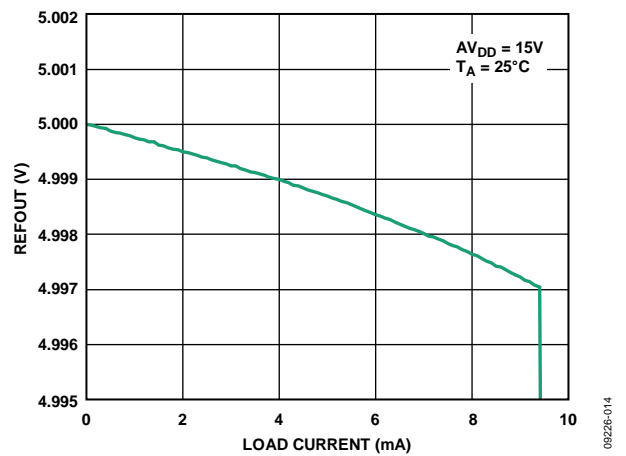

Figure 65. REFOUT vs. Load Current

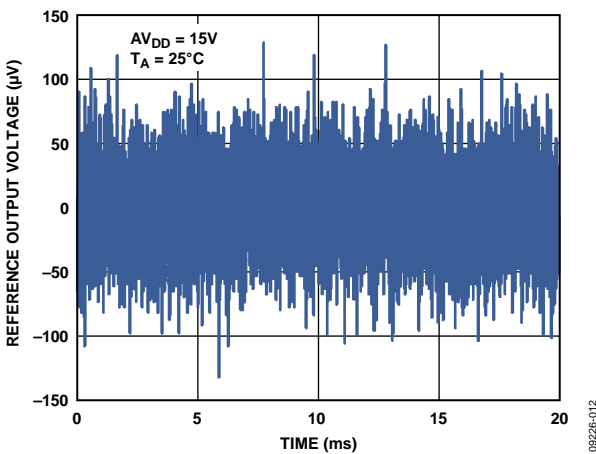

Figure 63. REFOUT Output Noise (100 kHz Bandwidth)

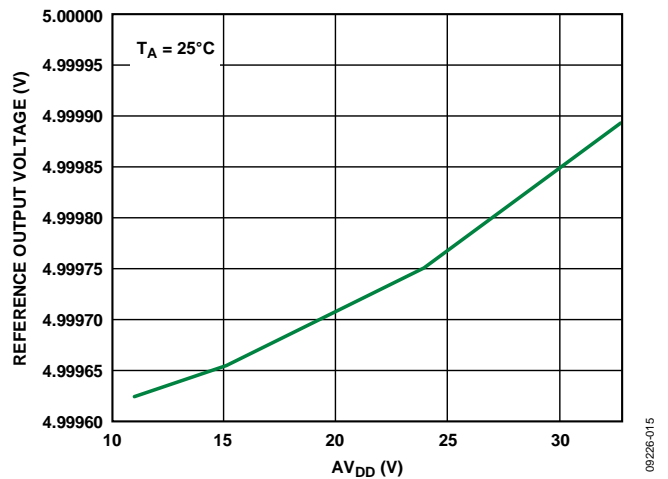

Figure 66. REFOUT vs. Supply

GENERAL

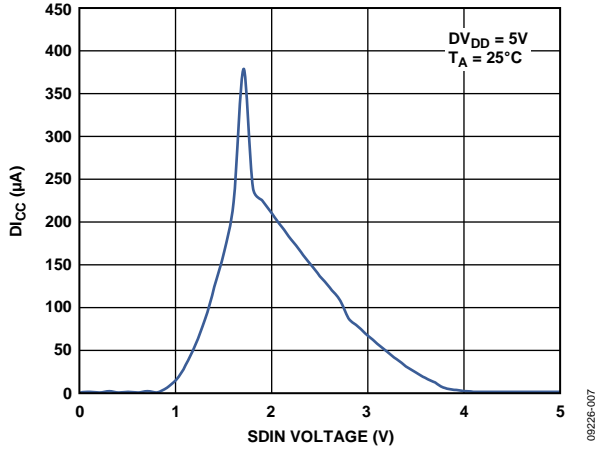

Figure 67.  $D_{Icc}$  vs. Logic Input Voltage

09226-007

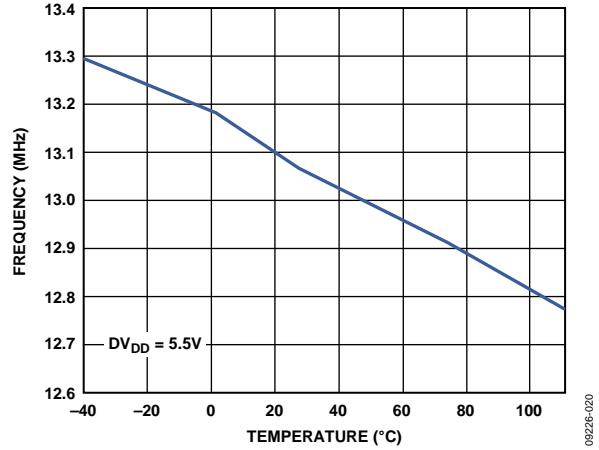

Figure 70. Internal Oscillator Frequency vs. Temperature

09226-020

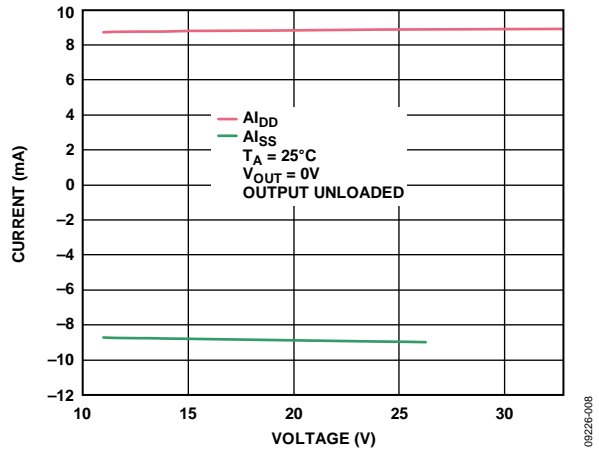

Figure 68.  $A_{I_{DD}}/A_{I_{SS}}$  vs.  $A_{V_{DD}}/A_{V_{SS}}$

09226-008

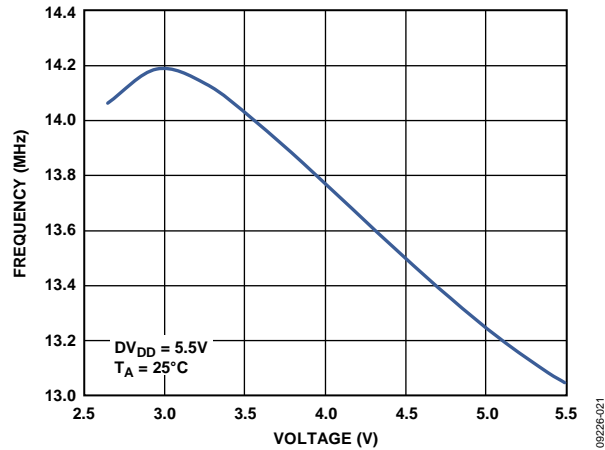

Figure 71. Internal Oscillator Frequency vs.  $DV_{DD}$  Supply Voltage

09226-021

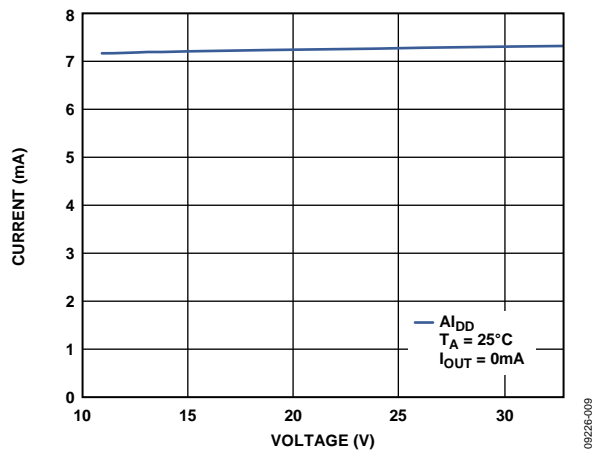

Figure 69.  $A_{I_{DD}}$  vs.  $A_{V_{DD}}$

09226-009

## TERMINOLOGY

### Relative Accuracy or Integral Nonlinearity (INL)

For the DAC, relative accuracy, or integral nonlinearity, is a measure of the maximum deviation, in LSBs, from the best fit line through the DAC transfer function. A typical INL vs. code plot is shown in Figure 9.

### Differential Nonlinearity (DNL)

Differential nonlinearity (DNL) is the difference between the measured change and the ideal 1 LSB change between any two adjacent codes. A specified differential nonlinearity of  $\pm 1$  LSB maximum ensures monotonicity. This DAC is guaranteed monotonic by design. A typical DNL vs. code plot is shown in Figure 10.

### Monotonicity

A DAC is monotonic if the output either increases or remains constant for increasing digital input code. The AD5755-1 is monotonic over its full operating temperature range.

### Negative Full-Scale Error/Zero-Scale Error

Negative full-scale error is the error in the DAC output voltage when 0x0000 (straight binary coding) is loaded to the DAC register.

### Zero-Scale TC

This is a measure of the change in zero-scale error with a change in temperature. Zero-scale error TC is expressed in ppm FSR/ $^{\circ}$ C.

### Bipolar Zero Error

Bipolar zero error is the deviation of the analog output from the ideal half-scale output of 0 V when the DAC register is loaded with 0x8000 (straight binary coding).

### Bipolar Zero TC

Bipolar zero TC is a measure of the change in the bipolar zero error with a change in temperature. It is expressed in ppm FSR/ $^{\circ}$ C.

### Offset Error

In voltage output mode, offset error is the deviation of the analog output from the ideal quarter-scale output when in bipolar output ranges and the DAC register is loaded with 0x4000 (straight binary coding).

In current output mode, offset error is the deviation of the analog output from the ideal zero-scale output when all DAC registers are loaded with 0x0000.

### Gain Error

This is a measure of the span error of the DAC. It is the deviation in slope of the DAC transfer characteristic from the ideal, expressed in % FSR.

### Gain TC

This is a measure of the change in gain error with changes in temperature. Gain TC is expressed in ppm FSR/ $^{\circ}$ C.

### Full-Scale Error

Full-scale error is a measure of the output error when full-scale code is loaded to the DAC register. Ideally, the output is full-scale  $- 1$  LSB. Full-scale error is expressed in percent of full-scale range (% FSR).

### Full-Scale TC

Full-scale TC is a measure of the change in full-scale error with changes in temperature and is expressed in ppm FSR/ $^{\circ}$ C.

### Total Unadjusted Error

Total unadjusted error (TUE) is a measure of the output error taking all the various errors into account, including INL error, offset error, gain error, temperature, and time. TUE is expressed in % FSR.

### DC Crosstalk

This is the dc change in the output level of one DAC in response to a change in the output of another DAC. It is measured with a full-scale output change on one DAC while monitoring another DAC, which is at midscale.

### Current Loop Compliance Voltage

The maximum voltage at the  $I_{OUT\_X}$  pin for which the output current is equal to the programmed value.

### Voltage Reference Thermal Hysteresis

Voltage reference thermal hysteresis is the difference in output voltage measured at  $+25^{\circ}$ C compared to the output voltage measured at  $+25^{\circ}$ C after cycling the temperature from  $+25^{\circ}$ C to  $-40^{\circ}$ C to  $+105^{\circ}$ C and back to  $+25^{\circ}$ C. The hysteresis is expressed in ppm.

### Output Voltage Settling Time

Output voltage settling time is the amount of time it takes for the output to settle to a specified level for a full-scale input change. A plot of settling time is shown in Figure 25, Figure 51, and Figure 52.

### Slew Rate

The slew rate of a device is a limitation in the rate of change of the output voltage. The output slewing speed of a voltage-output digital-to-analog converter is usually limited by the slew rate of the amplifier used at its output. Slew rate is measured from 10% to 90% of the output signal and is given in V/ $\mu$ s.

### Power-On Glitch Energy

Power-on glitch energy is the impulse injected into the analog output when the AD5755-1 is powered-on. It is specified as the area of the glitch in nV-sec. See Figure 30 and Figure 48.

**Digital-to-Analog Glitch Impulse**

Digital-to-analog glitch impulse is the impulse injected into the analog output when the input code in the DAC register changes state, but the output voltage remains constant. It is normally specified as the area of the glitch in nV-sec and is measured when the digital input code is changed by 1 LSB at the major carry transition (~0x7FFF to 0x8000). See Figure 27.

**Glitch Impulse Peak Amplitude**

Glitch impulse peak amplitude is the peak amplitude of the impulse injected into the analog output when the input code in the DAC register changes state. It is specified as the amplitude of the glitch in mV and is measured when the digital input code is changed by 1 LSB at the major carry transition (~0x7FFF to 0x8000). See Figure 27.

**Digital Feedthrough**

Digital feedthrough is a measure of the impulse injected into the analog output of the DAC from the digital inputs of the DAC but is measured when the DAC output is not updated. It is specified in nV-sec and measured with a full-scale code change on the data bus.

**DAC-to-DAC Crosstalk**

DAC-to-DAC crosstalk is the glitch impulse transferred to the output of one DAC due to a digital code change and a subsequent output change of another DAC. This includes both digital and analog crosstalk. It is measured by loading one of the DACs with a full-scale code change (all 0s to all 1s and vice versa) with LDAC low and monitoring the output of another DAC. The energy of the glitch is expressed in nV-sec.

**Power Supply Rejection Ratio (PSRR)**

PSRR indicates how the output of the DAC is affected by changes in the power supply voltage.

**Reference TC**

Reference TC is a measure of the change in the reference output voltage with a change in temperature. It is expressed in ppm/°C.

**Line Regulation**

Line regulation is the change in reference output voltage due to a specified change in supply voltage. It is expressed in ppm/V.

**Load Regulation**

Load regulation is the change in reference output voltage due to a specified change in load current. It is expressed in ppm/mA.

**DC-to-DC Converter Headroom**

This is the difference between the voltage required at the current output and the voltage supplied by the dc-to-dc converter. See Figure 54.

**Output Efficiency**

$$\frac{I_{OUT}^2 \times R_{LOAD}}{AV_{CC} \times AI_{CC}}$$

This is defined as the power delivered to a channel's load vs. the power delivered to the channel's dc-to-dc input.

**Efficiency at  $V_{BOOST\_x}$** 

$$\frac{I_{OUT} \times V_{BOOST\_x}}{AV_{CC} \times AI_{CC}}$$

This is defined as the power delivered to a channel's  $V_{BOOST\_x}$  supply vs. the power delivered to the dc-to-dc input of the channel. The  $V_{BOOST\_x}$  quiescent current is considered part of the dc-to-dc converter's losses.

## THEORY OF OPERATION

The AD5755-1 is a quad, precision digital-to-current loop and voltage output converter designed to meet the requirements of industrial process control applications. It provides a high precision, fully integrated, low cost, single-chip solution for generating current loop and unipolar/bipolar voltage outputs. The current ranges available are 0 mA to 20 mA, 0 mA to 24 mA, and 4 mA to 20 mA. The voltage ranges available are 0 V to 5 V,  $\pm 5$  V, 0 V to 10 V, and  $\pm 10$  V. The current and voltage outputs are available on separate pins, and only one is active at any one time. The desired output configuration is user selectable via the DAC control register.

On-chip dynamic power control minimizes package power dissipation in current mode.

### DAC ARCHITECTURE

The DAC core architecture of the AD5755-1 consists of two matched DAC sections. A simplified circuit diagram is shown in Figure 72. The four MSBs of the 16-bit data-word are decoded to drive 15 switches, E1 to E15. Each of these switches connects one of 15 matched resistors to either ground or the reference buffer output. The remaining 12 bits of the data-word drive Switch S0 to Switch S11 of a 12-bit voltage mode R-2R ladder network.

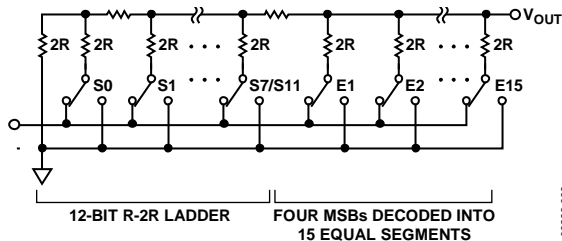

Figure 72. DAC Ladder Structure

The voltage output from the DAC core is either converted to a current (see Figure 74), which is then mirrored to the supply rail so that the application simply sees a current source output, or it is buffered and scaled to output a software selectable unipolar or bipolar voltage range (see Figure 73). Both the voltage and current outputs are supplied by  $V_{BOOST\_x}$ . The current and voltage are output on separate pins and cannot be output simultaneously. A channel's current and voltage output pins can be tied together.

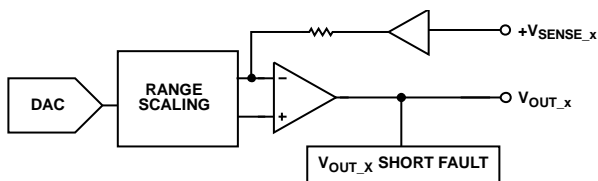

Figure 73. Voltage Output

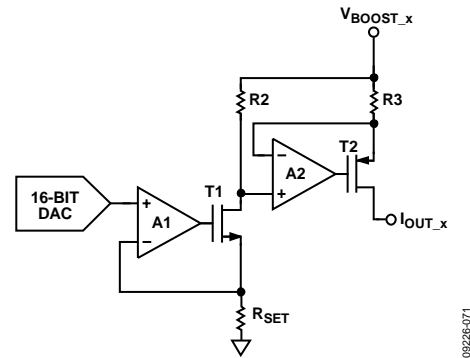

Figure 74. Voltage-to-Current Conversion Circuitry

### Voltage Output Amplifier

The voltage output amplifier is capable of generating both unipolar and bipolar output voltages. It is capable of driving a load of 1 k $\Omega$  in parallel with 1  $\mu$ F (with an external compensation capacitor) to AGND. The source and sink capabilities of the output amplifier are shown in Figure 24. The slew rate is 1.9 V/ $\mu$ s with a full-scale settling time of 16  $\mu$ s (10 V step). If remote sensing of the load is not required, connect + $V_{SENSE\_x}$  directly to  $V_{OUT\_x}$ . + $V_{SENSE\_x}$  must stay within  $\pm 3.0$  V of  $V_{OUT\_x}$  for correct operation.

### Driving Large Capacitive Loads

The voltage output amplifier is capable of driving capacitive loads of up to 2  $\mu$ F with the addition of a 220 pF nonpolarized compensation capacitor on each channel. Take care to choose an appropriate value of compensation capacitor. This capacitor, while allowing the AD5755-1 to drive higher capacitive loads and reduce overshoot, increases the settling time of the part and, therefore, affects the bandwidth of the system. Without the compensation capacitor, up to 10 nF capacitive loads can be driven. See Table 5 for information on connecting compensation capacitors.

### Reference Buffers

The AD5755-1 can operate with either an external or internal reference. The reference input requires a 5 V reference for specified performance. This input voltage is then buffered before it is applied to the DAC.

### POWER-ON STATE OF THE AD5755-1

On initial power-up of the AD5755-1, the power-on reset circuit powers up in a state that is dependent on the power-on condition (POC) pin.

If POC = 0, the voltage output and current output channels power up in tristate mode.

If POC = 1, the voltage output channel powers up with a 30 k $\Omega$  pull-down resistor to ground, and the current output channel powers up to tristate.

Even though the output ranges are not enabled, the default output range is 0 V to 5 V, and the clear code register is loaded with all zeros. This means that if the user clears the part after power-up, the output is actively driven to 0 V (if the channel has been enabled for clear).

After a device power-on, or a device reset, it is recommended to wait 100 μs or more before writing to the device to allow time for internal calibrations to take place.

**SERIAL INTERFACE**

The AD5755-1 is controlled over a versatile 3-wire serial interface that operates at clock rates of up to 30 MHz and is compatible with SPI, QSPI, MICROWIRE, and DSP standards. Data coding is always straight binary.

**Input Shift Register**

The input shift register is 24 bits wide. Data is loaded into the device MSB first as a 24-bit word under the control of a serial clock input, SCLK. Data is clocked in on the falling edge of SCLK.

If packet error checking, or PEC (see the Device Features section), is enabled, an additional eight bits must be written to the AD5755-1, creating a 32-bit serial interface.

There are two ways in which the DAC outputs can be updated: individual updating or simultaneous updating of all DACs.

**Individual DAC Updating**

In this mode, LDAC is held low while data is being clocked into the DAC data register. The addressed DAC output is updated on the rising edge of SYNC. See Table 3 and Figure 3 for timing information.

**Simultaneous Updating of All DACs**

In this mode, LDAC is held high while data is being clocked into the DAC data register. Only the first write to each channel’s DAC data register is valid after LDAC is brought high. Any subsequent writes while LDAC is still held high are ignored, though they are loaded into the DAC data register. All the DAC outputs are updated by taking LDAC low after SYNC is taken high.

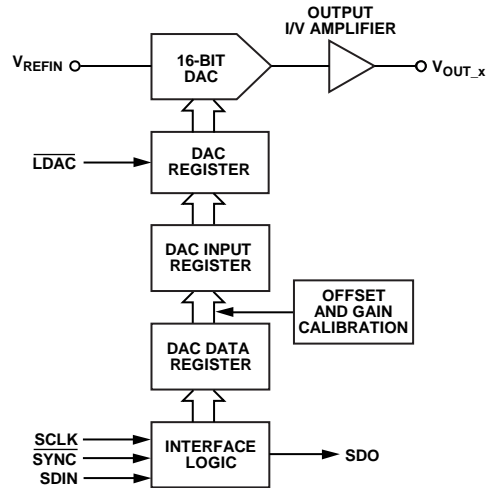

Figure 75. Simplified Serial Interface of Input Loading Circuitry for One DAC Channel

**TRANSFER FUNCTION**

Table 6 shows the input code to ideal output voltage relationship for the AD5755-1 for straight binary data coding of the ±10 V output range.

**Table 6. Ideal Output Voltage to Input Code Relationship**

Digital Input				Analog Output
Straight Binary Data Coding				
MSB		LSB		V <sub>OUT</sub>
1111	1111	1111	1111	+2 V <sub>REF</sub> × (32,767/32,768)
1111	1111	1111	1110	+2 V <sub>REF</sub> × (32,766/32,768)
1000	0000	0000	0000	0 V
0000	0000	0000	0001	-2 V <sub>REF</sub> × (32,767/32,768)
0000	0000	0000	0000	-2 V <sub>REF</sub>

## REGISTERS

Table 7 shows an overview of the registers for the AD5755-1.

**Table 7. Data, Control, and Readback Registers for the AD5755-1**

Register	Description
Data	
DAC Data Register (×4)	Used to write a DAC code to each DAC channel. AD5755-1 data bits = D15 to D0. There are four DAC data registers, one per DAC channel.
Gain Register (×4)	Used to program gain trim, on a per channel basis. AD5755-1 data bits = D15 to D0. There are four gain registers, one per DAC channel.
Offset Register (×4)	Used to program offset trim, on a per channel basis. AD5755-1 data bits = D15 to D0. There are four offset registers, one per DAC channel.
Clear Code Register (×4)	Used to program clear code on a per channel basis. AD5755-1 data bits = D15 to D0. There are four clear code registers, one per DAC channel.
Control	
Main Control Register	Used to configure the part for main operation. Sets functions such as status readback during write, enables output on all channels simultaneously, powers on all dc-to-dc converter blocks simultaneously, and enables and sets conditions of the watchdog timer. See the Device Features section for more details.
Software Register	Has three functions. Used to perform a reset, enables the packet error checking feature, and verifies correct data communication operation as part of the watchdog timer feature.
Slew Rate Control Register (×4)	Used to program the slew rate of the output. There are four slew rate control registers, one per channel.
DAC Control Register (×4)	These registers are used to control the following: Set the output range, for example, 4 mA to 20 mA, 0 V to 10 V. Set whether an internal/external sense resistor is used. Enable/disable a channel for CLEAR. Enable/disable overrange. Enable/disable internal circuitry on a per channel basis. Enable/disable output on a per channel basis. Power on dc-to-dc converters on a per channel basis. There are four DAC control registers, one per DAC channel.
DC-to-DC Control Register	Use to set the dc-to-dc control parameters. Can control dc-to-dc maximum voltage, phase, and frequency.
Readback	
Status Register	This contains any fault information, as well as the status of the packet error checking feature.

## PROGRAMMING SEQUENCE TO WRITE/ENABLE THE OUTPUT CORRECTLY

To correctly write to and set up the part from a power-on condition, use the following sequence:

1. Perform a hardware or software reset after initial power-on.
2. The dc-to-dc converter supply block must be configured. Set the dc-to-dc switching frequency, maximum output voltage allowed, and the phase that the four dc-to-dc channels clock at.
3. Configure the DAC control register on a per channel basis. The output range is selected, and the dc-to-dc converter block is enabled (DC\_DC bit). Other control bits can be configured at this point. Set the INT\_ENABLE bit; however, do not set the output enable bit (OUTEN).
4. Write the required code to the DAC data register. This implements a full DAC calibration internally. Allow at least 200  $\mu$ s before Step 5 for reduced output glitch.
5. Write to the DAC control register again to enable the output (set the OUTEN bit).

A flowchart of this sequence is shown in Figure 76.

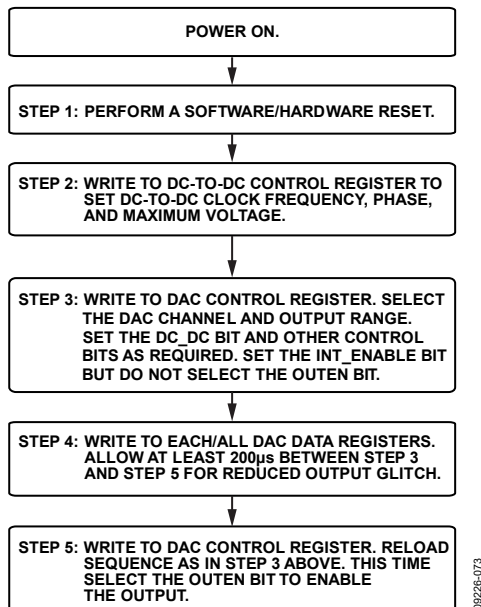

Figure 76. Programming Sequence for Enabling the Output Correctly

## CHANGING AND REPROGRAMMING THE RANGE

When changing between ranges, use the same sequence as described in the Programming Sequence to Write/Enable the Output Correctly section. It is recommended to set the range to its zero point (can be midscale or zero scale) prior to disabling the output. Because the dc-to-dc switching frequency, maximum voltage, and phase have already been selected, there is no need to reprogram these. A flowchart of this sequence is shown in Figure 77.

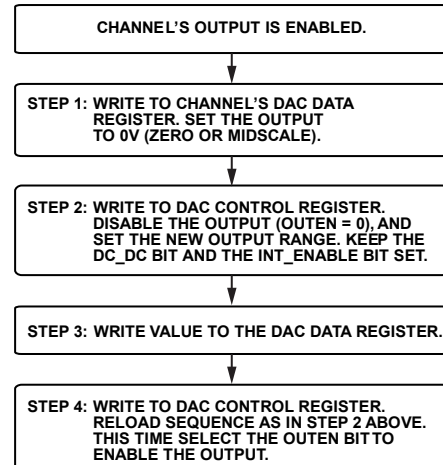

Figure 77. Steps for Changing the Output Range



**DATA REGISTERS**

The input register is 24 bits wide. When PEC is enabled, the input register is 32 bits wide, with the last eight bits corresponding to the PEC code (see the Packet Error Checking section for more information on PEC). When writing to a data register, the format in Table 8 must be used.

**DAC Data Register**

When writing to the AD5755-1 DAC data registers, D15 to D0 are used for DAC data bits. Table 10 shows the register format and Table 9 describes the function of Bit D23 to Bit D16.

**Table 8. Writing to a Data Register**

MSB							LSB	
D23	D22	D21	D20	D19	D18	D17	D16	D15 to D0
R/W	DUT_AD1	DUT_AD0	DREG2	DREG1	DREG0	DAC_AD1	DAC_AD0	Data

**Table 9. Input Register Decode**

Bit	Description			
R/W	Indicates a read from or a write to the addressed register.			
DUT_AD1, DUT_AD0	Used in association with the external pins, AD1 and AD0, to determine which AD5755-1 device is being addressed by the system controller. It is not recommended to tie both AD1 and AD0 low when using PEC, see the Packet Error Checking section.			
	<b>DUT_AD1</b>	<b>DUT_AD0</b>	<b>Function</b>	
	0	0	Addresses part with Pin AD1 = 0, Pin AD0 = 0	
	0	1	Addresses part with Pin AD1 = 0, Pin AD0 = 1	
	1	0	Addresses part with Pin AD1 = 1, Pin AD0 = 0	
	1	1	Addresses part with Pin AD1 = 1, Pin AD0 = 1	
DREG2, DREG1, DREG0	Selects whether a data register or a control register is written to. If a control register is selected, a further decode of CREG bits (see Table 17) is required to select the particular control register, as follows.			
	<b>DREG2</b>	<b>DREG1</b>	<b>DREG0</b>	<b>Function</b>
	0	0	0	Write to DAC data register (individual channel write)
	0	1	0	Write to gain register
	0	1	1	Write to gain register (all DACs)
	1	0	0	Write to offset register
	1	0	1	Write to offset register (all DACs)
	1	1	0	Write to clear code register
	1	1	1	Write to a control register
DAC_AD1, DAC_AD0	These bits are used to decode the DAC channel.			
	<b>DAC_AD1</b>	<b>DAC_AD0</b>	<b>DAC Channel/Register Address</b>	
	0	0	DAC A	
	0	1	DAC B	
	1	0	DAC C	
	1	1	DAC D	
	X	X	These are don't cares if they are not relevant to the operation being performed.	

**Table 10. Programming the DAC Data Registers**

MSB							LSB	
D23	D22	D21	D20	D19	D18	D17	D16	D15 to D0
R/W	DUT_AD1	DUT_AD0	DREG2	DREG1	DREG0	DAC_AD1	DAC_AD0	DAC data

**Gain Register**

The 16-bit gain register, as shown in Table 11, allows the user to adjust the gain of each channel in steps of 1 LSB. This is done by setting the DREG[2:0] bits to 010. It is possible to write the same gain code to all four DAC channels at the same time by setting the DREG[2:0] bits to 011. The gain register coding is straight binary as shown in Table 12. The default code in the gain register is 0xFFFF. In theory, the gain can be tuned across the full range of the output. In practice, the maximum recommended gain trim is about 50% of programmed range to maintain accuracy. See the Digital Offset and Gain Control section for more information.

**Offset Register**

The 16-bit offset register, as shown in Table 13, allows the user to adjust the offset of each channel by  $-32,768$  LSBs to  $+32,768$  LSBs

in steps of 1 LSB. This is done by setting the DREG[2:0] bits to 100. It is possible to write the same offset code to all four DAC channels at the same time by setting the DREG[2:0] bits to 101. The offset register coding is straight binary as shown in Table 14. The default code in the offset register is 0x8000, which results in zero offset programmed to the output. See the Digital Offset and Gain Control section for more information.

**Clear Code Register**

The 16-bit clear code register allows the user to set the clear value of each channel as shown in Table 15. It is possible, via software, to enable or disable on a per channel basis which channels are cleared when the CLEAR pin is activated. The default clear code is 0x0000. See the Asynchronous Clear section for more information.

**Table 11. Programming the Gain Register**

R/W	DUT_AD1	DUT_AD0	DREG2	DREG1	DREG0	DAC_AD1	DAC_AD0	D15 to D0
0	Device address		0	1	0	DAC channel address		Gain adjustment

**Table 12. Gain Register**

Gain Adjustment	G15	G14	G13	G12 to G4	G3	G2	G1	G0
+65,535 LSBs	1	1	1	1	1	1	1	1
+65,534 LSBs	1	1	1	1	1	1	1	0
...	...	...	...	...	...	...	...	...
1 LSB	0	0	0	0	0	0	0	1
0 LSBs	0	0	0	0	0	0	0	0

**Table 13. Programming the Offset Register**

R/W	DUT_AD1	DUT_AD0	DREG2	DREG1	DREG0	DAC_AD1	DAC_AD0	D15 to D0
0	Device address		1	0	0	DAC channel address		Offset adjustment

**Table 14. Offset Register Options**

Offset Adjustment	OF15	OF14	OF13	OF12 to OF4	OF3	OF2	OF1	OF0
+32,768 LSBs	1	1	1	1	1	1	1	1
+32,767 LSBs	1	1	1	1	1	1	1	0
+32,766 LSBs	1	1	1	1	1	1	0	0
...	...	...	...	...	...	...	...	...
No Adjustment (Default)	1	0	0	0	0	0	0	0
...	...	...	...	...	...	...	...	...
-32,767 LSBs	0	0	0	0	0	0	0	1
-32,768 LSBs	0	0	0	0	0	0	0	0

**Table 15. Programming the Clear Code Register**

R/W	DUT_AD1	DUT_AD0	DREG2	DREG1	DREG0	DAC_AD1	DAC_AD0	D15 to D0
0	Device address		1	1	0	DAC channel address		Clear code

## CONTROL REGISTERS

When writing to a control register, use the format shown in Table 16. See Table 9 for information on the configuration of Bit D23 to Bit D16. The control registers are addressed by setting the DREG[2:0] bits to 111 and then setting the CREG[2:0] bits to the appropriate decode address for that register, according to Table 17. These CREG bits select among the various control registers.

**Table 16. Writing to a Control Register**

MSB							LSB				
D23	D22	D21	D20	D19	D18	D17	D16	D15	D14	D13	D12 to D0
R/W	DUT_AD1	DUT_AD0	1	1	1	DAC_AD1	DAC_AD0	CREG2	CREG1	CREG0	Data

**Table 17. Register Access Decode**

CREG2 (D15)	CREG1 (D14)	CREG0 (D13)	Function
0	0	0	Slew rate control register (one per channel)
0	0	1	Main control register
0	1	0	DAC control register (one per channel)
0	1	1	DC-to-dc control register
1	0	0	Software register

**Table 18. Programming the Main Control Register**

MSB											LSB	
D15	D14	D13	D12	D11	D10	D9	D8	D7	D6	D5	D4	D3 to D0
0	0	1	POC	STATREAD	EWD	WD1	WD0	X <sup>1</sup>	SHTCCTIM	OUTEN_ALL	DCDC_ALL	X <sup>1</sup>

<sup>1</sup> X = don't care.

**Table 19. Main Control Register Functions**

Bit	Description															
POC	The POC bit determines the state of the voltage output channels during normal operation. Its default value is 0. POC = 0. The output goes to the value set by the POC hardware pin when the voltage output is not enabled (default). POC = 1. The output goes to the opposite value of the POC hardware pin if the voltage output is not enabled.															
STATREAD	Enable status readback during a write. See the Device Features section. STATREAD = 1, enable. STATREAD = 0, disable (default).															
EWD	Enable watchdog timer. See the Device Features section for more information. EWD = 1, enable watchdog. EWD = 0, disable watchdog (default).															
WD1, WD0	Timeout select bits. Used to select the timeout period for the watchdog timer. <table border="1" data-bbox="300 1514 812 1686"> <thead> <tr> <th>WD1</th> <th>WD0</th> <th>Timeout Period (ms)</th> </tr> </thead> <tbody> <tr> <td>0</td> <td>0</td> <td>5</td> </tr> <tr> <td>0</td> <td>1</td> <td>10</td> </tr> <tr> <td>1</td> <td>0</td> <td>100</td> </tr> <tr> <td>1</td> <td>1</td> <td>200</td> </tr> </tbody> </table>	WD1	WD0	Timeout Period (ms)	0	0	5	0	1	10	1	0	100	1	1	200
WD1	WD0	Timeout Period (ms)														
0	0	5														
0	1	10														
1	0	100														
1	1	200														
SHTCCTIM	Programmable short-circuit limit on the V <sub>OUT_x</sub> pin in the event of a short-circuit condition. 0 = 16 mA (default). 1 = 8 mA.															
OUTEN_ALL	Enables the output on all four DACs simultaneously. Do not use the OUTEN_ALL bit when using the OUTEN bit in the DAC control register.															
DCDC_ALL	When set, powers up the dc-to-dc converter on all four channels simultaneously. To power down the dc-to-dc converters, all channel outputs must first be disabled. Do not use the DCDC_ALL bit when using the DC_DC bit in the DAC control register.															

**DAC Control Register**

The DAC control register is used to configure each DAC channel. The DAC control register options are shown in Table 20 and Table 21.

**Table 20. Programming DAC Control Register**

D15	D14	D13	D12	D11	D10	D9	D8	D7	D6	D5	D4	D3	D2	D1	D0
0	1	0	X <sup>1</sup>	X <sup>1</sup>	X <sup>1</sup>	X <sup>1</sup>	INT_ENABLE	CLR_EN	OUTEN	RSET	DC_DC	OVRNG	R2	R1	R0

<sup>1</sup>X = don't care.

**Table 21. DAC Control Register Functions**

Bit	Description																																
INT_ENABLE	Powers up the dc-to-dc converter, DAC, and internal amplifiers for the selected channel. Does not enable the output. Can only be done on a per channel basis. It is recommended to set this bit and allow a >200 $\mu$ s delay before enabling the output because this results in a reduced output enable glitch. See Figure 31 and Figure 49 for plots of this glitch.																																
CLR_EN	Per channel clear enable bit. Selects if this channel clears when the CLEAR pin is activated. CLR_EN = 1, channel clears when the part is cleared. CLR_EN = 0, channel does not clear when the part is cleared (default).																																
OUTEN	Enables/disables the selected output channel. OUTEN = 1, enables the channel. OUTEN = 0, disables the channel (default).																																
RSET	Selects an internal or external current sense resistor for the selected DAC channel. RSET = 0, selects the external resistor (default). RSET = 1, selects the internal resistor.																																
DC_DC	Powers the dc-to-dc converter on the selected channel. DC_DC = 1, power up the dc-to-dc converter. DC_DC = 0, power down the dc-to-dc converter (default). This allows per channel dc-to-dc converter power-up/power-down. To power down the dc-to-dc converter, the OUTEN and INT_ENABLE bits must also be set to 0. All dc-to-dc converters can also be powered up simultaneously using the DCDC_ALL bit in the main control register.																																
OVRNG	Enables 20% overrange on voltage output channel only. No current output overrange available. OVRNG = 1, enabled. OVRNG = 0, disabled (default).																																
R2, R1, R0	Selects the output range to be enabled.																																
	<table border="1"> <thead> <tr> <th>R2</th> <th>R1</th> <th>R0</th> <th>Output Range Selected</th> </tr> </thead> <tbody> <tr> <td>0</td> <td>0</td> <td>0</td> <td>0 V to 5 V voltage range (default).</td> </tr> <tr> <td>0</td> <td>0</td> <td>1</td> <td>0 V to 10 V voltage range.</td> </tr> <tr> <td>0</td> <td>1</td> <td>0</td> <td><math>\pm</math>5 V voltage range.</td> </tr> <tr> <td>0</td> <td>1</td> <td>1</td> <td><math>\pm</math>10 V voltage range.</td> </tr> <tr> <td>1</td> <td>0</td> <td>0</td> <td>4 mA to 20 mA current range.</td> </tr> <tr> <td>1</td> <td>0</td> <td>1</td> <td>0 mA to 20 mA current range.</td> </tr> <tr> <td>1</td> <td>1</td> <td>0</td> <td>0 mA to 24 mA current range.</td> </tr> </tbody> </table>	R2	R1	R0	Output Range Selected	0	0	0	0 V to 5 V voltage range (default).	0	0	1	0 V to 10 V voltage range.	0	1	0	$\pm$ 5 V voltage range.	0	1	1	$\pm$ 10 V voltage range.	1	0	0	4 mA to 20 mA current range.	1	0	1	0 mA to 20 mA current range.	1	1	0	0 mA to 24 mA current range.
R2	R1	R0	Output Range Selected																														
0	0	0	0 V to 5 V voltage range (default).																														
0	0	1	0 V to 10 V voltage range.																														
0	1	0	$\pm$ 5 V voltage range.																														
0	1	1	$\pm$ 10 V voltage range.																														
1	0	0	4 mA to 20 mA current range.																														
1	0	1	0 mA to 20 mA current range.																														
1	1	0	0 mA to 24 mA current range.																														

**Software Register**

The software register has three functions. It allows the user to perform a software reset to the device and enable the packet error checking feature (see the Packet Error Checking section). It is also used as part of the watchdog feature when it is enabled. This feature is useful to ensure that communication is not lost between the MCU and the AD5755-1 and that the datapath lines are working properly (that is, SDIN, SCLK, and SYNC).

When the watchdog feature is enabled, the user must write 0x195 to the software register within the timeout period. If this command is not received within the timeout period, the ALERT pin signals a fault condition. This is only required when the watchdog timer function is enabled.

**DC-to-DC Control Register**

The dc-to-dc control register allows the user control over the dc-to-dc switching frequency and phase, as well as the maximum allowable dc-to-dc output voltage. The dc-to-dc control register options are shown in Table 24 and Table 25.

**Table 22. Programming the Software Register**

MSB				LSB
D15	D14	D13	D12	D11 to D0
1	0	0	PEC enable	Reset code/SPI code

**Table 23. Software Register Functions**

Bit	Description	
PEC Enable	This bit selects if the packet error checking feature is enabled (see the Packet Error Checking section). 0 = PEC disabled. 1 = PEC enabled.	
Reset Code/SPI Code	Option	Description
	Reset code SPI code	Writing 0x555 to D[11:0] performs a reset of the AD5755-1. If the watchdog timer feature is enabled, 0x195 must be written to the software register (D11 to D0) within the programmed timeout period.

**Table 24. Programming the DC-to-DC Control Register**

MSB						LSB	
D15	D14	D13	D12 to D7	D6	D5 to D4	D3 to D2	D1 to D0
0	1	1	X <sup>1</sup>	DC-DC Comp	DC-DC phase	DC-DC Freq	DC-DC MaxV

<sup>1</sup>X = don't care.

**Table 25. DC-to-DC Control Register Options**

Bit	Description
DC-DC Comp	Selects between an internal and external compensation resistor for the dc-to-dc converter. See the DC-to-DC Converter Compensation Capacitors and AICC Supply Requirements—Slewing sections in the Device Features section for more information. 0 = selects the internal 150 kΩ compensation resistor (default). 1 = bypasses the internal compensation resistor for the dc-to-dc converter. In this mode, an external dc-to-dc compensation resistor must be used; this is placed at the COMP <sub>DCDC_x</sub> pin in series with the 10 nF dc-to-dc compensation capacitor to ground. Typically, a ~50 kΩ resistor is recommended.
DC-DC Phase	User programmable dc-to-dc converter phase (between channels). 00 = all dc-to-dc converters clock on the same edge (default). 01 = Channel A and Channel B clock on the same edge, Channel C and Channel D clock on opposite edges. 10 = Channel A and Channel C clock on the same edge, Channel B and Channel D clock on opposite edges. 11 = Channel A, Channel B, Channel C, and Channel D clock 90° out of phase from each other.
DC-DC Freq	DC-to-dc switching frequency; these are divided down from the internal 13 MHz oscillator (see Figure 70 and Figure 71). 00 = 250 ± 10% kHz. 01 = 410 ± 10% kHz (default). 10 = 650 ± 10% kHz.
DC-DC MaxV	Maximum allowed V <sub>BOOST_x</sub> voltage supplied by the dc-to-dc converter. 00 = 23 V + 1 V/−1.5 V (default). 01 = 24.5 V ± 1 V. 10 = 27 V ± 1 V. 11 = 29.5 V ± 1 V.

### Slew Rate Control Register

This register is used to program the slew rate control for the selected DAC channel. This feature is available on both the current and voltage outputs. The slew rate control is enabled/disabled and programmed on a per channel basis. See Table 26 and the Digital Slew Rate Control section for more information.

### READBACK OPERATION

Readback mode is invoked by setting the  $\overline{R/W}$  bit = 1 in the serial input register write. See Table 27 and Table 28 for the bits associated with a readback operation. The DUT\_AD1 and DUT\_AD0 bits, in association with the RD[4:0] bits, select the register to be read. The remaining data bits in the write sequence are don't cares.

During the next SPI transfer (see Figure 4), either a no operation (NOP) or a request to read another register must be issued.

**Table 26. Programming the Slew Rate Control Register**

D15	D14	D13	D12	D11 to D7	D6 to D3	D2 to D0
0	0	0	SREN	X <sup>1</sup>	SR_CLOCK	SR_STEP

<sup>1</sup> X = don't care.

**Table 27. Input Shift Register Contents for a Read Operation**

D23	D22	D21	D20	D19	D18	D17	D16	D15 to D0
R/W	DUT_AD1	DUT_AD0	RD4	RD3	RD2	RD1	RD0	X <sup>1</sup>

<sup>1</sup> X = don't care.

**Table 28. Read Address Decoding**

RD4	RD3	RD2	RD1	RD0	Function
0	0	0	0	0	Read DAC A data register
0	0	0	0	1	Read DAC B data register
0	0	0	1	0	Read DAC C data register
0	0	0	1	1	Read DAC D data register
0	0	1	0	0	Read DAC A control register
0	0	1	0	1	Read DAC B control register
0	0	1	1	0	Read DAC C control register
0	0	1	1	1	Read DAC D control register
0	1	0	0	0	Read DAC A gain register
0	1	0	0	1	Read DAC B gain register
0	1	0	1	0	Read DAC C gain register
0	1	0	1	1	Read DAC D gain register
0	1	1	0	0	Read DACA offset register
0	1	1	0	1	Read DAC B offset register
0	1	1	1	0	Read DAC C offset register
0	1	1	1	1	Read DAC D offset register
1	0	0	0	0	Clear DAC A code register
1	0	0	0	1	Clear DAC B code register
1	0	0	1	0	Clear DAC C code register
1	0	0	1	1	Clear DAC D code register
1	0	1	0	0	DAC A slew rate control register
1	0	1	0	1	DAC B slew rate control register
1	0	1	1	0	DAC C slew rate control register
1	0	1	1	1	DAC D slew rate control register
1	1	0	0	0	Read status register
1	1	0	0	1	Read main control register
1	1	0	1	0	Read dc-to-dc control register

Meanwhile, the SDO returns 24 bits, the 8 MSBs are don't cares, and the 16 LSBs contain the data from the addressed register. If PEC is enabled, the SDO returns 32 bits (Figure 5), with 8 CRC bits appended to the data readback.

### Readback Example

To read back the gain register of Device 1, Channel A on the AD5755-1, implement the following sequence:

1. Write 0xA80000 to the AD5755-1 input register. This configures the AD5755-1 Device Address 1 for read mode with the gain register of Channel A selected. All the data bits, D15 to D0, are don't cares.
2. Follow with another read command or a no operation command (0x3CE000). During this command, the data from the Channel A gain register is clocked out on the SDO line.

**Status Register**

The status register is a read only register. This register contains any fault information, the status of the packet error checking feature, and a ramp active bit. When the STATREAD bit in the main control register is set, the status register contents can be

read back on the SDO pin during every write sequence. Alternatively, if the STATREAD bit is not set, the status register can be read using the normal readback operation.

**Table 29. Decoding the Status Register**

MSB													LSB			
D15	D14	D13	D12	D11	D10	D9	D8	D7	D6	D5	D4	D3	D2	D1	D0	
DC-DCD	DC-DCC	DC-DCB	DC-DCA	PEC enabled	PEC error	Ramp active	Over TEMP	V <sub>OUT_D</sub> fault	V <sub>OUT_C</sub> fault	V <sub>OUT_B</sub> fault	V <sub>OUT_A</sub> fault	I <sub>OUT_D</sub> fault	I <sub>OUT_C</sub> fault	I <sub>OUT_B</sub> fault	I <sub>OUT_A</sub> fault	

**Table 30. Status Register Options**

Bit	Description
DC-DCD	In current output mode, this bit is set on Channel D if the dc-to-dc converter cannot maintain compliance (it may be reaching its V <sub>MAX</sub> voltage). In this case, the I <sub>OUT_D</sub> fault bit is also set. See the DC-to-DC Converter V <sub>MAX</sub> Functionality section for more information on the operation of this bit under this condition. In voltage output mode, this bit is set if, on Channel D, the dc-to-dc converter is unable to regulate to 15 V as expected. When this bit is set, it does not result in the FAULT pin going high.
DC-DCC	In current output mode, this bit is set on Channel C if the dc-to-dc converter cannot maintain compliance (it may be reaching its V <sub>MAX</sub> voltage). In this case, the I <sub>OUT_C</sub> fault bit is also set. See the DC-to-DC Converter V <sub>MAX</sub> Functionality section for more information on the operation of this bit under this condition. In voltage output mode, this bit is set if, on Channel C, the dc-to-dc converter is unable to regulate to 15 V as expected. When this bit is set, it does not result in the FAULT pin going high.
DC-DCB	In current output mode, this bit is set on Channel B if the dc-to-dc converter cannot maintain compliance (it may be reaching its V <sub>MAX</sub> voltage). In this case, the I <sub>OUT_B</sub> fault bit is also set. See the DC-to-DC Converter V <sub>MAX</sub> Functionality section for more information on the operation of this bit under this condition. In voltage output mode, this bit is set if, on Channel B, the dc-to-dc converter is unable to regulate to 15 V as expected. When this bit is set, it does not result in the FAULT pin going high.
DC-DCA	In current output mode, this bit is set on Channel A if the dc-to-dc converter cannot maintain compliance (it may be reaching its V <sub>MAX</sub> voltage). In this case, the I <sub>OUT_A</sub> fault bit is also set. See the DC-to-DC Converter V <sub>MAX</sub> Functionality section for more information on the operation of this bit under this condition. In voltage output mode, this bit is set if, on Channel A, the dc-to-dc converter is unable to regulate to 15 V as expected. When this bit is set, it does not result in the FAULT pin going high.
PEC Enabled	This is a read only bit. It allows the user to verify the status of the packet error checking feature.
PEC Error	Denotes a PEC error on the last data-word received over the SPI interface.
Ramp Active	This bit is set while any one of the output channels is slewing (slew rate control is enabled on at least one channel).
Over TEMP	This bit is set if the AD5755-1 core temperature exceeds approximately 150°C.
V <sub>OUT_D</sub> Fault	This bit is set if a fault is detected on the V <sub>OUT_D</sub> pin.
V <sub>OUT_C</sub> Fault	This bit is set if a fault is detected on the V <sub>OUT_C</sub> pin.
V <sub>OUT_B</sub> Fault	This bit is set if a fault is detected on the V <sub>OUT_B</sub> pin.
V <sub>OUT_A</sub> Fault	This bit is set if a fault is detected on the V <sub>OUT_A</sub> pin.
I <sub>OUT_D</sub> Fault	This bit is set if a fault is detected on the I <sub>OUT_D</sub> pin.
I <sub>OUT_C</sub> Fault	This bit is set if a fault is detected on the I <sub>OUT_C</sub> pin.
I <sub>OUT_B</sub> Fault	This bit is set if a fault is detected on the I <sub>OUT_B</sub> pin.
I <sub>OUT_A</sub> Fault	This bit is set if a fault is detected on the I <sub>OUT_A</sub> pin.

## DEVICE FEATURES

### OUTPUT FAULT

The AD5755-1 is equipped with a **FAULT** pin, an active low open-drain output allowing several AD5755-1 devices to be connected together to one pull-up resistor for global fault detection. The **FAULT** pin is forced active by any one of the following fault scenarios:

- The voltage at  $I_{OUT\_x}$  attempts to rise above the compliance range due to an open-loop circuit or insufficient power supply voltage. The internal circuitry that develops the fault output avoids using a comparator with windowed limits because this requires an actual output error before the **FAULT** output becomes active. Instead, the signal is generated when the internal amplifier in the output stage has less than approximately 1 V of remaining drive capability. Thus, the **FAULT** output activates slightly before the compliance limit is reached.
- A short is detected on a voltage output pin. The short-circuit current is limited to 16 mA or 8 mA, which is programmable by the user. If using the AD5755-1 in unipolar supply mode, a short-circuit fault may be generated if the output voltage is below 50 mV.
- An interface error is detected due to a PEC failure. See the Packet Error Checking section.
- If the core temperature of the AD5755-1 exceeds approximately 150°C.

The  $V_{OUT\_x}$  fault,  $I_{OUT\_x}$  fault, PEC error, and over TEMP bits of the status register are used in conjunction with the **FAULT** output to inform the user which one of the fault conditions caused the **FAULT** output to be activated.

### VOLTAGE OUTPUT SHORT-CIRCUIT PROTECTION

Under normal operation, the voltage output sinks/sources up to 12 mA and maintains specified operation. The maximum output current or short-circuit current is programmable by the user and can be set to 16 mA or 8 mA. If a short circuit is detected, the **FAULT** goes low and the relevant  $V_{OUT\_x}$  fault bit in the status register is set.

### DIGITAL OFFSET AND GAIN CONTROL

Each DAC channel has a gain (M) and offset (C) register, which allow trimming out of the gain and offset errors of the entire signal chain. Data from the DAC data register is operated on by a digital multiplier and adder controlled by the contents of the M and C registers. The calibrated DAC data is then stored in the DAC input register.

Although Figure 78 indicates a multiplier and adder for each channel, there is only one multiplier and one adder in the device, and they are shared among all four channels. This has

implications for the update speed when several channels are updated at once (see Table 3).

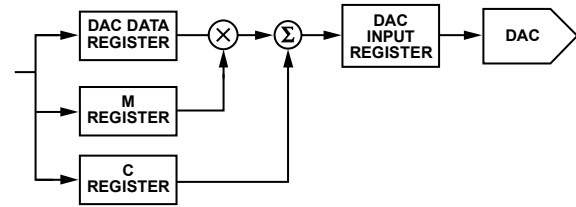

Figure 78. Digital Offset and Gain Control

Each time data is written to the M or C register, the output is not automatically updated. Instead, the next write to the DAC channel uses these M and C values to perform a new calibration and automatically updates the channel.

The output data from the calibration is routed to the DAC input register. This is then loaded to the DAC as described in the Theory of Operation section. Both the gain register and the offset register have 16 bits of resolution. The correct method to calibrate the gain/offset is to first calibrate out the gain and then calibrate the offset.

The value (in decimal) that is written to the DAC input register can be calculated by

$$Code_{DACRegister} = D \times \frac{(M+1)}{2^{16}} + C - 2^{15} \quad (1)$$

where:

D is the code loaded to the DAC channel's input register.

M is the code in the gain register (default code =  $2^{16} - 1$ ).

C is the code in the offset register (default code =  $2^{15}$ ).

### STATUS READBACK DURING A WRITE

The AD5755-1 has the ability to read back the status register contents during every write sequence. This feature is enabled via the STATREAD bit in the main control register. This allows the user to continuously monitor the status register and act quickly in the case of a fault.

When status readback during a write is enabled, the contents of the 16-bit status register (see Table 30) are output on the SDO pin, as shown in Figure 6.

The AD5755-1 powers up with this feature disabled. When this is enabled, the normal readback feature is not available, except for the status register. To read back any other register, clear the STATREAD bit first before following the readback sequence. STATREAD can be set high again after the register read.

If there are multiple units on the same SDO bus which have the STATREAD feature enabled, ensure that each unit is provided a unique physical address (AD1 and AD0) to prevent contention on the bus.



### ASYNCHRONOUS CLEAR

CLEAR is an active high, edge-sensitive input that allows the output to be cleared to a preprogrammed 16-bit code. This code is user programmable via a per channel 16-bit clear code register.

For a channel to clear, that channel must be enabled to be cleared via the CLR\_EN bit in the channel’s DAC control register. If the channel is not enabled to be cleared, then the output remains in its current state independent of the CLEAR pin level. When the CLEAR signal is returned low, the relevant outputs remain cleared until a new value is programmed.

### PACKET ERROR CHECKING

To verify that data has been received correctly in noisy environments, the AD5755-1 offers the option of packet error checking based on an 8-bit cyclic redundancy check (CRC-8). The device controlling the AD5755-1 generates an 8-bit frame check sequence using the polynomial

$$C(x) = x_8 + x_2 + x_1 + 1$$

This is added to the end of the data-word, and 32 bits are sent to the AD5755-1 before taking SYNC high. If the packet error checking enable bit is set high (Bit 12 in the software register), the user must supply a 32-bit frame that contains the 24 data bits and 8-bit CRC. If the check is valid, the data is written to the selected register. If the error check fails, the FAULT pin goes low and the PEC error bit in the status register is set. After reading the status register, FAULT returns high (assuming there are no other faults), and the PEC error bit is cleared automatically. It is not recommended to tie both AD1 and AD0 low because a short low on SDIN, that is, a command of 16 zeroes, may possibly lead to a zero-scale update for DAC A. The PEC can be used for both transmit and receive of data packets.

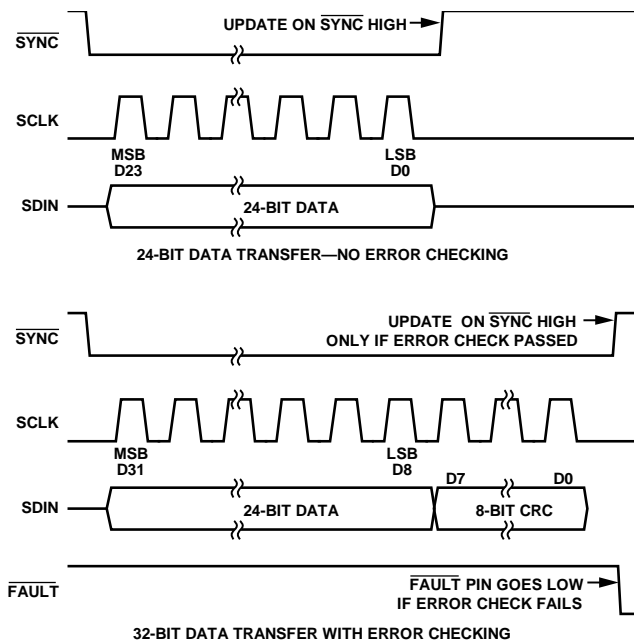

Figure 79. PEC Timing

### WATCHDOG TIMER

When enabled, an on-chip watchdog timer generates an alert signal if 0x195 has not been written to the software register within the programmed timeout period. This feature is useful to ensure that communication is not lost between the MCU and the AD5755-1 and that these datapath lines are working properly (that is, SDIN, SCLK, and SYNC). If 0x195 is not received by the software register within the timeout period, the ALERT pin signals a fault condition. The ALERT signal is active high and can be connected directly to the CLEAR pin to enable a clear in the event that communication from the MCU is lost.

The watchdog timer is enabled, and the timeout period (5 ms, 10 ms, 100 ms, or 200 ms) is set in the main control register (see Table 18 and Table 19).

### OUTPUT ALERT

The AD5755-1 is equipped with an ALERT pin. This is an active high CMOS output. The AD5755-1 also has an internal watchdog timer. When enabled, it monitors SPI communications. If 0x195 is not received by the software register within the timeout period, the ALERT pin goes active.

### INTERNAL REFERENCE

The AD5755-1 contains an integrated +5 V voltage reference with initial accuracy of ±5 mV maximum and a temperature drift coefficient of ±10 ppm maximum. The reference voltage is buffered and externally available for use elsewhere within the system. REFOUT must be connected to REFIN to use the internal reference.

### EXTERNAL CURRENT SETTING RESISTOR

Referring to Figure 74, R<sub>SET</sub> is an internal sense resistor as part of the voltage-to-current conversion circuitry. The stability of the output current value over temperature is dependent on the stability of the value of R<sub>SET</sub>. As a method of improving the stability of the output current over temperature, an external 15 kΩ low drift resistor can be connected to the R<sub>SET,x</sub> pin of the AD5755-1 to be used instead of the internal resistor, R<sub>1</sub>. The external resistor is selected via the DAC control register (see Table 20).

Table 1 outlines the performance specifications of the AD5755-1 with both the internal R<sub>SET</sub> resistor and an external, 15 kΩ R<sub>SET</sub> resistor. Using an external R<sub>SET</sub> resistor allows for improved performance over the internal R<sub>SET</sub> resistor option. The external R<sub>SET</sub> resistor specification assumes an ideal resistor; the actual performance depends on the absolute value and temperature coefficient of the resistor used. This directly affects the gain error of the output, and thus the total unadjusted error. To arrive at the gain/TUE error of the output with a particular external R<sub>SET</sub> resistor, add the percentage absolute error of the R<sub>SET</sub> resistor directly to the gain/TUE error of the AD5755-1 with the external R<sub>SET</sub> resistor, shown in Table 1 (expressed in % FSR).

## HART CONNECTIVITY

The AD5755-1 has four CHART pins, one corresponding to each output channels. A HART signal can be coupled into these pins. The HART signal appears on the corresponding current output, if the output is enabled. Table 31 shows the recommended input voltages for the HART signal at the CHART pin. If these voltages are used, the current output must meet the HART amplitude specifications. Figure 80 shows the recommended circuit for attenuating and coupling in the HART signal.

**Table 31. CHART Input Voltage to HART Output Current**

R <sub>SET</sub>	CHART Input Voltage	Current Output (HART)
Internal R <sub>SET</sub>	150 mV p-p	1 mA p-p
External R <sub>SET</sub>	170 mV p-p	1 mA p-p

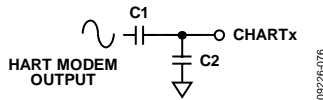

Figure 80. Coupling HART Signal

A minimum capacitance of C1 + C2 is required to ensure that the 1.2 kHz and 2.2 kHz HART frequencies are not significantly attenuated at the output. The recommended values are C1 = 22 nF, C2 = 47 nF.

Digitally controlling the slew rate of the output is necessary to meet the analog rate of change requirements for HART.

If the HART feature is not required, leave the CHART pins open circuit.

## DIGITAL SLEW RATE CONTROL

The slew rate control feature of the AD5755-1 allows the user to control the rate at which the output value changes. This feature is available on both the current and voltage outputs. With the slew rate control feature disabled, the output value changes at a rate limited by the output drive circuitry and the attached load. To reduce the slew rate, this can be achieved by enabling the slew rate control feature. With the feature enabled via the SREN bit of the slew rate control register (see Table 26), the output, instead of slewing directly between two values, steps digitally at a rate defined by two parameters accessible via the slew rate control register, as shown in Table 26.

The parameters are SR\_CLOCK and SR\_STEP. SR\_CLOCK defines the rate at which the digital slew is updated, for example, if the selected update rate is 8 kHz, the output updates every 125  $\mu$ s. In conjunction with this, SR\_STEP defines by how much the output value changes at each update. Together, both parameters define the rate of change of the output value. Table 32 and Table 33 outline the range of values for both the SR\_CLOCK and SR\_STEP parameters.

**Table 32. Slew Rate Update Clock Options**

SR_CLOCK	Update Clock Frequency (Hz) <sup>1</sup>
0000	64 k
0001	32 k
0010	16 k
0011	8 k
0100	4 k
0101	2 k
0110	1 k
0111	500
1000	250
1001	125
1010	64
1011	32
1100	16
1101	8
1110	4
1111	0.5

<sup>1</sup> These clock frequencies are divided down from the 13 MHz internal oscillator. See Table 1, Figure 70, and Figure 71.

**Table 33. Slew Rate Step Size Options**

SR_STEP	Step Size (LSBs)
000	1
001	2
010	4
011	16
100	32
101	64
110	128
111	256

The following equation describes the slew rate as a function of the step size, the update clock frequency, and the LSB size:

$$\text{Slew Time} = \frac{\text{Output Change}}{\text{Step Size} \times \text{Update Clock Frequency} \times \text{LSB Size}}$$

where:

Slew Time is expressed in seconds.

Output Change is expressed in amps for I<sub>OUT,x</sub> or volts for V<sub>OUT,x</sub>.

When the slew rate control feature is enabled, all output changes occur at the programmed slew rate (see the DC-to-DC Converter Settling Time section for additional information). For example, if the CLEAR pin is asserted, the output slews to the clear value at the programmed slew rate (assuming that the clear channel is enabled to be cleared). If a number of channels are enabled for slew, care must be taken when asserting the CLEAR pin. If one of the channels is slewing when CLEAR is asserted, other channels may change directly to their clear values not under slew rate control. The update clock frequency for any given value is the same for all output ranges. The step size, however, varies

across output ranges for a given value of step size because the LSB size is different for each output range.

**POWER DISSIPATION CONTROL**

The AD5755-1 contains integrated dynamic power control using a dc-to-dc boost converter circuit, allowing reductions in power consumption from standard designs when using the part in current output mode.

In standard current input module designs, the load resistor values can range from typically 50 Ω to 750 Ω. Output module systems must source enough voltage to meet the compliance voltage requirement across the full range of load resistor values. For example, in a 4 mA to 20 mA loop when driving 20 mA, a compliance voltage of >15 V is required. When driving 20 mA into a 50 Ω load, only 1 V compliance is required.

The AD5755-1 circuitry senses the output voltage and regulates this voltage to meet compliance requirements plus a small headroom voltage. The AD5755-1 is capable of driving up to 24 mA through a 1 kΩ load.

**DC-TO-DC CONVERTERS**

The AD5755-1 contains four independent dc-to-dc converters. These are used to provide dynamic control of the V<sub>BOOST</sub> supply voltage for each channel (see Figure 74). Figure 81 shows the discrete components needed for the dc-to-dc circuitry, and the following sections describe component selection and operation of this circuitry.

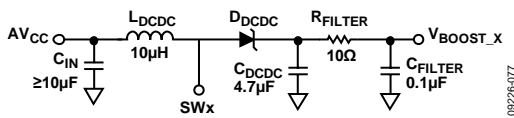

Figure 81. DC-to-DC Circuit

**Table 34. Recommended DC-to-DC Components**

Symbol	Component	Value	Manufacturer
L <sub>DCDC</sub>	XAL4040-103	10 µH	Coilcraft®
C <sub>DCDC</sub>	GRM32ER71H475KA88L	4.7 µF	Murata
D <sub>DCDC</sub>	PD3S160-7	0.55 V <sub>F</sub>	Diodes, Inc.

It is recommended to place a 10 Ω, 100 nF low-pass RC filter after C<sub>DCDC</sub>. This consumes a small amount of power but reduces the amount of ripple on the V<sub>BOOST\_x</sub> supply.

**DC-to-DC Converter Operation**

The on-board dc-to-dc converters use a constant frequency, peak current mode control scheme to step up an AV<sub>CC</sub> input of 4.5 V to 5.5 V to drive the AD5755-1 output channel. These are designed to operate in discontinuous conduction mode (DCM) with a duty cycle of <90% typical. Discontinuous conduction mode refers to a mode of operation where the inductor current goes to zero for an appreciable percentage of the switching cycle. The dc-to-dc converters are nonsynchronous; that is, they require an external Schottky diode.

**DC-to-DC Converter Output Voltage**

When a channel current output is enabled, the converter regulates the V<sub>BOOST\_x</sub> supply to 7.4 V (±5%) or (I<sub>OUT\_x</sub> × R<sub>LOAD</sub> + Headroom), whichever is greater (see Figure 54 for a plot of headroom supplied vs. output current). In voltage output mode with the output disabled, the converter regulates the V<sub>BOOST\_x</sub> supply to +15 V (±5%). In current output mode with the output disabled, the converter regulates the V<sub>BOOST\_x</sub> supply to 7.4 V (±5%).

Within a channel, the V<sub>OUT\_x</sub> and I<sub>OUT\_x</sub> stages share a common V<sub>BOOST\_x</sub> supply so that the outputs of the I<sub>OUT\_x</sub> and V<sub>OUT\_x</sub> stages can be tied together.

**DC-to-DC Converter Settling Time**

When in current output mode, the settling time for a step greater than ~1 V (I<sub>OUT\_x</sub> × R<sub>LOAD</sub>) is dominated by the settling time of the dc-to-dc converter. The exception to this is when the required voltage at the I<sub>OUT\_x</sub> pin plus the compliance voltage is below 7.4 V (±5%). A typical plot of the output settling time can be found in Figure 50. This plot is for a 1 kΩ load. The settling time for smaller loads is faster. The settling time for current steps less than 24 mA is also faster.

**DC-to-DC Converter V<sub>MAX</sub> Functionality**

The maximum V<sub>BOOST\_x</sub> voltage is set in the dc-to-dc control register (23 V, 24.5 V, 27 V, or 29.5 V; see Table 25). On reaching this maximum voltage, the dc-to-dc converter is disabled, and the V<sub>BOOST\_x</sub> voltage is allowed to decay by ~0.4 V. After the V<sub>BOOST\_x</sub> voltage has decayed by ~0.4 V, the dc-to-dc converter is reenabled, and the voltage ramps up again to V<sub>MAX</sub>, if still required. This operation is shown in Figure 82.

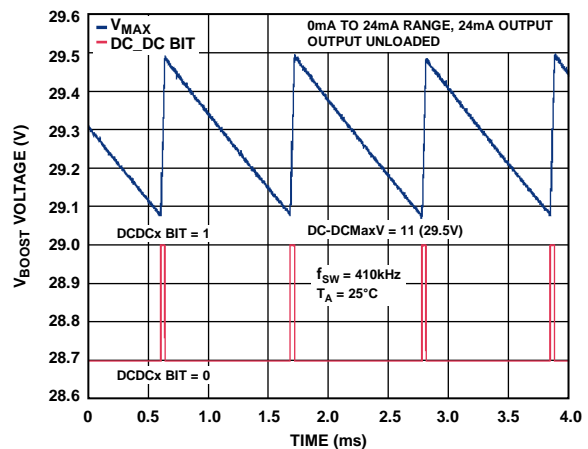

Figure 82. Operation on Reaching V<sub>MAX</sub>

As can be seen in Figure 82, the DC-DCx bit in the status register asserts when the AD5755-1 is ramping to the V<sub>MAX</sub> value but deasserts when the voltage is decaying to V<sub>MAX</sub> - ~0.4 V.

### DC-to-DC Converter On-Board Switch

The AD5755-1 contains a 0.425  $\Omega$  internal switch. The switch current is monitored on a pulse by pulse basis and is limited to 0.8 A peak current.

### DC-to-DC Converter Switching Frequency and Phase

The AD5755-1 dc-to-dc converter switching frequency can be selected from the dc-to-dc control register. The phasing of the channels can also be adjusted so that the dc-to-dc converter can clock on different edges (see Table 25). For typical applications, a 410 kHz frequency is recommended. At light loads (low output current and small load resistor), the dc-to-dc converter enters a pulse-skipping mode to minimize switching power dissipation.

### DC-to-DC Converter Inductor Selection

For typical 4 mA to 20 mA applications, a 10  $\mu\text{H}$  inductor (such as the XAL4040-103 from Coilcraft), combined with a switching frequency of 410 kHz, allows up to 24 mA to be driven into a load resistance of up to 1 k $\Omega$  with an  $A_{V_{CC}}$  supply of 4.5 V to 5.5 V. It is important to ensure that the inductor is able to handle the peak current without saturating, especially at the maximum ambient temperature. If the inductor enters into saturation mode, it results in a decrease in efficiency. The inductance value also drops during saturation and may result in the dc-to-dc converter circuit not being able to supply the required output power.

### DC-to-DC Converter External Schottky Selection

The AD5755-1 requires an external Schottky for correct operation. Ensure that the Schottky is rated to handle the maximum reverse breakdown expected in operation and that the rectifier maximum junction temperature is not exceeded. The diode average current is approximately equal to the  $I_{LOAD}$  current. Diodes with larger forward voltage drops result in a decrease in efficiency.

### DC-to-DC Converter Compensation Capacitors

As the dc-to-dc converter operates in DCM, the uncompensated transfer function is essentially a single-pole transfer function. The pole frequency of the transfer function is determined by the output capacitance of the dc-to-dc converter, input and output voltage, and output load. The AD5755-1 uses an external capacitor in conjunction with an internal 150 k $\Omega$  resistor to compensate the regulator loop. Alternatively, an external compensation resistor can be used in series with the compensation capacitor, by setting the DC-DC Comp bit in the dc-to-dc control register. In this case, a  $\sim$ 50 k $\Omega$  resistor is recommended. A description of the advantages of this can be found in the  $A_{I_{CC}}$  Supply Requirements—Slewing section. For typical applications, a 10 nF dc-to-dc compensation capacitor is recommended.

### DC-to-DC Converter Input and Output Capacitor Selection

The output capacitor affects ripple voltage of the dc-to-dc converter and indirectly limits the maximum slew rate at which

the channel output current can rise. The ripple voltage is caused by a combination of the capacitance and equivalent series resistance (ESR) of the capacitor. For the AD5755-1, a ceramic capacitor of 4.7  $\mu\text{F}$  is recommended for typical applications.

Larger capacitors or paralleled capacitors improve the ripple at the expense of reduced slew rate. Larger capacitors also impact the  $A_{V_{CC}}$  supplies current requirements while slewing (see the  $A_{I_{CC}}$  Supply Requirements—Slewing section). This capacitance at the output of the dc-to-dc converter must be  $>3 \mu\text{F}$  under all operating conditions.

The input capacitor provides much of the dynamic current required for the dc-to-dc converter and must be a low ESR component. For the AD5755-1, a low ESR tantalum or ceramic capacitor of 10  $\mu\text{F}$  is recommended for typical applications. Ceramic capacitors must be chosen carefully because they can exhibit a large sensitivity to dc bias voltages and temperature. X5R or X7R dielectrics are preferred because these capacitors remain stable over wider operating voltage and temperature ranges. Care must be taken if selecting a tantalum capacitor to ensure a low ESR value.

## $A_{I_{CC}}$ SUPPLY REQUIREMENTS—STATIC

The dc-to-dc converter is designed to supply a  $V_{BOOST_x}$  voltage of

$$V_{BOOST} = I_{OUT} \times R_{LOAD} + \text{Headroom} \quad (2)$$

See Figure 54 for a plot of headroom supplied vs. output voltage. This means that, for a fixed load and output voltage, the dc-to-dc converter output current can be calculated by the following formula:

$$A_{I_{CC}} = \frac{\text{Power Out}}{\text{Efficiency} \times A_{V_{CC}}} = \frac{I_{OUT} \times V_{BOOST}}{\eta_{V_{BOOST}} \times A_{V_{CC}}} \quad (3)$$

where:

$I_{OUT}$  is the output current from  $I_{OUT_x}$  in amps.

$\eta_{V_{BOOST}}$  is the efficiency at  $V_{BOOST_x}$  as a fraction (see Figure 56 and Figure 57).

## $A_{I_{CC}}$ SUPPLY REQUIREMENTS—SLEWING

The  $A_{I_{CC}}$  current requirement while slewing is greater than in static operation because the output power increases to charge the output capacitance of the dc-to-dc converter. This transient current can be quite large (see Figure 83), although the methods described in the Reducing  $A_{I_{CC}}$  Current Requirements section can reduce the requirements on the  $A_{V_{CC}}$  supply. If not enough  $A_{I_{CC}}$  current can be provided, the  $A_{V_{CC}}$  voltage drops. Due to this  $A_{V_{CC}}$  drop, the  $A_{I_{CC}}$  current required to slew increases further. This means that the voltage at  $A_{V_{CC}}$  drops further (see Equation 3) and the  $V_{BOOST_x}$  voltage, and thus the output voltage, may never reach its intended value. Because this  $A_{V_{CC}}$  voltage is common to all channels, this may also affect other channels.

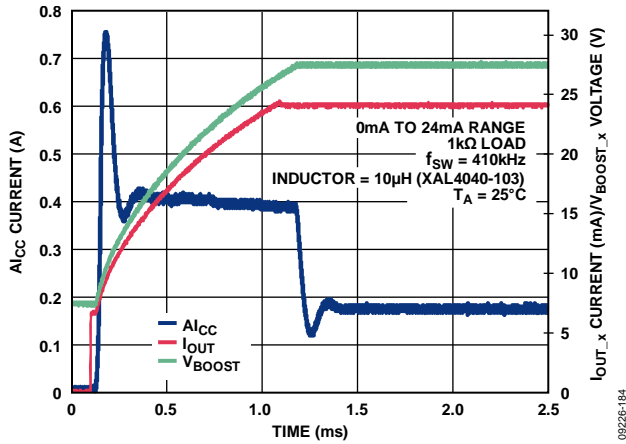

Figure 83.  $A_{I_{CC}}$  Current vs. Time for 24 mA Step Through 1 kΩ Load with Internal Compensation Resistor

**Reducing  $A_{I_{CC}}$  Current Requirements**

There are two main methods that can be used to reduce the  $A_{I_{CC}}$  current requirements. One method is to add an external compensation resistor, and the other is to use slew rate control. Both of these methods can be used in conjunction.

A compensation resistor can be placed at the  $COMP_{DCDC_x}$  pin in series with the 10 nF compensation capacitor. A 51 kΩ external compensation resistor is recommended. This compensation increases the slew time of the current output but eases the  $A_{I_{CC}}$  transient current requirements. Figure 84 shows a plot of  $A_{I_{CC}}$  current for a 24 mA step through a 1 kΩ load when using a 51 kΩ compensation resistor. This method eases the current requirements through smaller loads even further, as shown in Figure 85.

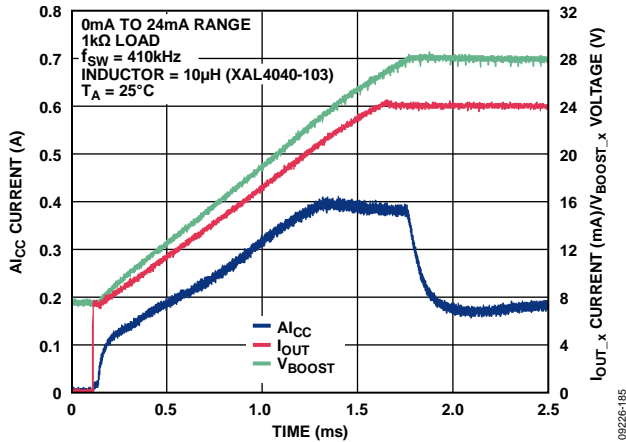

Figure 84.  $A_{I_{CC}}$  Current vs. Time for 24 mA Step Through 1 kΩ Load with External 51 kΩ Compensation Resistor

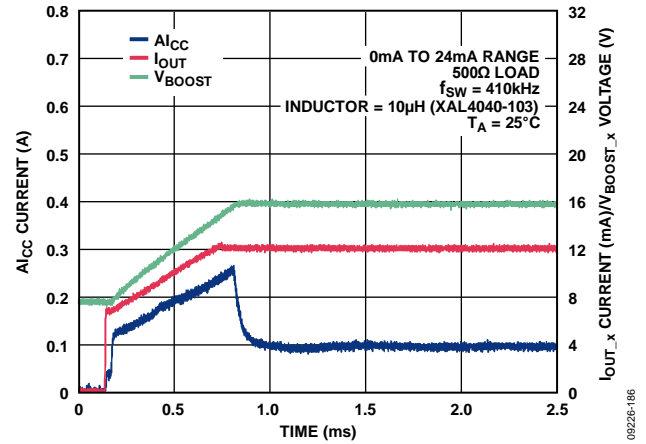

Figure 85.  $A_{I_{CC}}$  Current vs. Time for 24 mA Step Through 500 Ω Load with External 51 kΩ Compensation Resistor

Using slew rate control can greatly reduce the  $A_{V_{CC}}$  supplies current requirements, as shown in Figure 86. When using slew rate control, pay attention to the fact that the output cannot slew faster than the dc-to-dc converter. The dc-to-dc converter slews slowest at higher currents through large (for example, 1 kΩ) loads. This slew rate is also dependent on the configuration of the dc-to-dc converter. Two examples of the dc-to-dc converter output slew are shown in Figure 84 and Figure 85 ( $V_{BOOST}$  corresponds to the output voltage of the dc-to-dc converter).

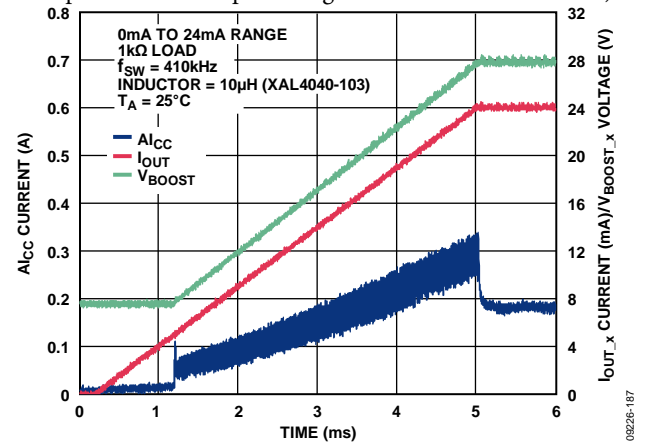

Figure 86.  $A_{I_{CC}}$  Current vs. Time for 24 mA Step Through 1 kΩ Load with Slew Rate Control

## APPLICATIONS INFORMATION

### VOLTAGE AND CURRENT OUTPUT RANGES ON THE SAME TERMINAL

When using a channel of the AD5755-1, the current and voltage output pins can be connected to two separate terminals or tied together and connected to a single terminal. There is no conflict with tying the two output pins together because only the voltage output or the current output can be enabled at any one time.

When the current output is enabled, the voltage output is in tristate mode, and when the voltage output is enabled, the current output is in tristate mode. For this operation, the POC pin must be tied low and the POC bit in the main control register set to 0, or, if the POC pin is tied high, the POC bit in the main control register must be set to 1 before the current output is enabled.

As shown in the Absolute Maximum Ratings section, the output tolerances are the same for both the voltage and current output pins. The  $+V_{SENSE,x}$  connections are buffered so that current leakage into these pins is negligible when in current output mode.

### CURRENT OUTPUT MODE WITH INTERNAL $R_{SET}$

When using the internal  $R_{SET}$  resistor in current output mode, the output is significantly affected by how many other channels using the internal  $R_{SET}$  are enabled and by the dc crosstalk from these channels. The internal  $R_{SET}$  specifications in Table 1 are for all channels enabled with the internal  $R_{SET}$  selected and outputting the same code.

For every channel enabled with the internal  $R_{SET}$ , the offset error decreases. For example, with one current output enabled using the internal  $R_{SET}$ , the offset error is 0.075% FSR. This value decreases proportionally as more current channels are enabled; the offset error is 0.056% FSR on each of two channels, 0.029% on each of three channels, and 0.01% on each of four channels.

Similarly, the dc crosstalk when using the internal  $R_{SET}$  is proportional to the number of current output channels enabled with the internal  $R_{SET}$ . For example, with the measured channel at 0x8000 and one channel going from zero to full scale, the dc crosstalk is  $-0.011\%$  FSR. With two channels going from zero to full scale, it is  $-0.019\%$  FSR, and with all three other channels going from zero to full scale, it is  $-0.025\%$  FSR.

For the full-scale error measurement in Table 1, all channels are at 0xFFFF. This means that, as any channel goes to zero scale,

the full-scale error increases due to the dc crosstalk. For example, with the measured channel at 0xFFFF and three channels at zero scale, the full-scale error is 0.025%. Similarly, if only one channel is enabled in current output mode with the internal  $R_{SET}$ , the full-scale error is  $0.025\% \text{ FSR} + 0.075\% \text{ FSR} = 0.1\% \text{ FSR}$ .

### PRECISION VOLTAGE REFERENCE SELECTION

To achieve the optimum performance from the AD5755-1 over its full operating temperature range, a precision voltage reference must be used. Give thought to the selection of a precision voltage reference. The voltage applied to the reference inputs is used to provide a buffered reference for the DAC cores. Therefore, any error in the voltage reference is reflected in the outputs of the device.

There are four possible sources of error to consider when choosing a voltage reference for high accuracy applications: initial accuracy, temperature coefficient of the output voltage, long term drift, and output voltage noise.

Initial accuracy error on the output voltage of an external reference can lead to a full-scale error in the DAC. Therefore, to minimize these errors, a reference with low initial accuracy error specification is preferred. Choosing a reference with an output trim adjustment, such as the [ADR425](#), allows a system designer to trim system errors out by setting the reference voltage to a voltage other than the nominal. The trim adjustment can be used at any temperature to trim out any error.

Long-term drift is a measure of how much the reference output voltage drifts over time. A reference with a tight long-term drift specification ensures that the overall solution remains relatively stable over its entire lifetime.

The temperature coefficient of a reference's output voltage affects INL, DNL, and TUE. Choose a reference with a tight temperature coefficient specification to reduce the dependence of the DAC output voltage to ambient temperature.

In high accuracy applications, which have a relatively low noise budget, reference output voltage noise must be considered. Choosing a reference with as low an output noise voltage as practical for the system resolution required is important. Precision voltage references such as the [ADR435](#) (XFET design) produce low output noise in the 0.1 Hz to 10 Hz region. However, as the circuit bandwidth increases, filtering the output of the reference may be required to minimize the output noise.

Table 35. Recommended Precision References

Part No.	Initial Accuracy (mV Maximum)	Long-Term Drift (ppm Typical)	Temperature Drift (ppm/°C Maximum)	0.1 Hz to 10 Hz Noise (μV p-p Typical)
<a href="#">ADR445</a>	±2	50	3	2.25
<a href="#">ADR02</a>	±3	50	3	10
<a href="#">ADR435</a>	±2	40	3	8
<a href="#">ADR395</a>	±5	50	9	8
<a href="#">AD586</a>	±2.5	15	10	4

## DRIVING INDUCTIVE LOADS

When driving inductive or poorly defined loads, a capacitor may be required between  $I_{OUT\_x}$  and AGND to ensure stability. A 0.01  $\mu\text{F}$  capacitor between  $I_{OUT\_x}$  and AGND ensures stability of a load of 50 mH. The capacitive component of the load may cause slower settling, although this may be masked by the settling time of the AD5755-1. There is no maximum capacitance limit for the current output of the AD5755-1.

## TRANSIENT VOLTAGE PROTECTION

The AD5755-1 contains ESD protection diodes that prevent damage from normal handling. The industrial control environment can, however, subject I/O circuits to much higher transients. To protect the AD5755-1 from excessively high voltage transients, external power diodes and a surge current limiting resistor ( $R_P$ ) are required, as shown in Figure 87. A typical value for  $R_P$  is 10  $\Omega$ . The two protection diodes and the resistor ( $R_P$ ) must have appropriate power ratings.

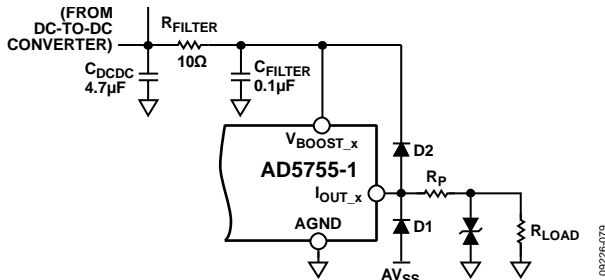

Figure 87. Output Transient Voltage Protection

Further protection can be provided using transient voltage suppressors (TVSs), also referred to as transorbs. These components are available as unidirectional suppressors, which protect against positive high voltage transients, and as bidirectional suppressors, which protect against both positive and negative high voltage transients. Transient voltage suppressors are available in a wide range of standoff and breakdown voltage ratings. The TVS must be sized with the lowest breakdown voltage possible while not conducting in the functional range of the current output.

It is recommended that all field connected nodes be protected. The voltage output node can be protected with a similar circuit, where D2 and the transorb are connected to  $AV_{SS}$ . For the voltage output node, the  $+V_{SENSE\_x}$  pin must also be protected with a large value series resistance to the transorb, such as 5 k $\Omega$ . In this way, the  $I_{OUT\_x}$  and  $V_{OUT\_x}$  pins can also be tied together and share the same protection circuitry.

## MICROPROCESSOR INTERFACING

Microprocessor interfacing to the AD5755-1 is via a serial bus that uses a protocol compatible with microcontrollers and DSP processors. The communications channel is a 3-wire minimum interface consisting of a clock signal, a data signal, and a latch signal. The AD5755-1 requires a 24-bit data-word with data valid on the falling edge of SCLK.

The DAC output update is initiated on either the rising edge of LDAC or, if LDAC is held low, on the rising edge of SYNC. The contents of the registers can be read using the readback function.

### AD5755-1-to-ADSP-BF527 Interface

The AD5755-1 can be connected directly to the SPORT interface of the ADSP-BF527, an Analog Devices, Inc., Blackfin<sup>®</sup> DSP. Figure 88 shows how the SPORT interface can be connected to control the AD5755-1.

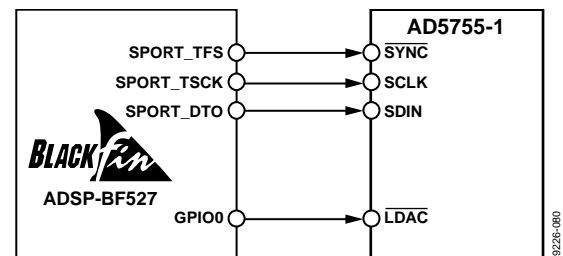

Figure 88. AD5755-1-to-ADSP-BF527 SPORT Interface

## LAYOUT GUIDELINES

### Grounding

In any circuit where accuracy is important, careful consideration of the power supply and ground return layout helps to ensure the rated performance. The printed circuit board on which the AD5755-1 is mounted must be designed so that the analog and digital sections are separated and confined to certain areas of the board. If the AD5755-1 is in a system where multiple devices require an AGND-to-DGND connection, the connection must be made at one point only. The star ground point must be established as close as possible to the device.

The  $GNDSW_x$  and ground connection for the  $AV_{CC}$  supply are referred to as PGND. PGND must be confined to certain areas of the board, and the PGND-to-AGND connection must be made at one point only.

### Supply Decoupling

The AD5755-1 must have ample supply bypassing of 10  $\mu\text{F}$  in parallel with 0.1  $\mu\text{F}$  on each supply located as close to the package as possible, ideally right up against the device. The 10  $\mu\text{F}$  capacitors are the tantalum bead type. The 0.1  $\mu\text{F}$  capacitor must have low effective series resistance (ESR) and low effective series inductance (ESL), such as the common ceramic types, which provide a low impedance path to ground at high frequencies to handle transient currents due to internal logic switching.



### Traces

The power supply lines of the AD5755-1 must use as large a trace as possible to provide low impedance paths and reduce the effects of glitches on the power supply line. Shield fast switching signals, such as clocks, with digital ground to prevent radiating noise to other parts of the board and never run them near the reference inputs. A ground line routed between the SDIN and SCLK lines helps reduce crosstalk between them (not required on a multilayer board that has a separate ground plane, but separating the lines helps). It is essential to minimize noise on the REFIN line because it couples through to the DAC output.

Avoid crossover of digital and analog signals. Traces on opposite sides of the board must run at right angles to each other. This reduces the effects of feedthrough on the board. A microstrip technique is by far the best but not always possible with a double-sided board. In this technique, the component side of the board is dedicated to ground plane, whereas signal traces are placed on the solder side.

### DC-to-DC Converters

To achieve high efficiency, good regulation, and stability, a well-designed printed circuit board layout is required.

Follow these guidelines when designing printed circuit boards (see Figure 81):

- Keep the low ESR input capacitor,  $C_{IN}$ , close to  $AV_{CC}$  and PGND.
- Keep the high current path from  $C_{IN}$  through the inductor,  $L_{DCDC}$ , to  $SW_X$  and PGND as short as possible.
- Keep the high current path from  $C_{IN}$  through  $L_{DCDC}$  and the rectifier,  $D_{DCDC}$ , to the output capacitor,  $C_{DCDC}$ , as short as possible.
- Keep high current traces as short and as wide as possible. The path from  $C_{IN}$  through the inductor,  $L_{DCDC}$ , to  $SW_X$  and PGND must be able to handle a minimum of 1 A.
- Place the compensation components as close as possible to  $COMP_{DCDC_x}$ .
- Avoid routing high impedance traces near any node connected to  $SW_x$  or near the inductor to prevent radiated noise injection.

### GALVANICALLY ISOLATED INTERFACE

In many process control applications, it is necessary to provide an isolation barrier between the controller and the unit being controlled to protect and isolate the controlling circuitry from any hazardous common-mode voltages that may occur. The Analog Devices *iCoupler*® products can provide voltage isolation in excess of 2.5 kV. The serial loading structure of the AD5755-1 makes it ideal for isolated interfaces because the number of interface lines is kept to a minimum. Figure 89 shows a 4-channel isolated interface to the AD5755-1 using an ADuM1400. For more information, visit [www.analog.com](http://www.analog.com).

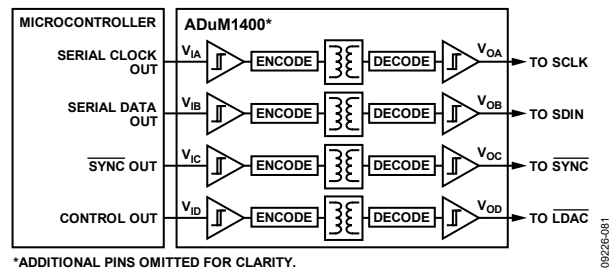

Figure 89. Isolated Interface



**INDUSTRIAL HART CAPABLE ANALOG OUTPUT APPLICATION—SHARED  $V_{OUT\_X}$  AND  $I_{OUT\_X}$  PIN**

Many industrial control applications have requirements for accurately controlled current output signals, and the AD5755-1 is ideal for such applications. Figure 90 shows the AD5755-1 in a circuit design for a HART-enabled output module, specifically for use in an industrial control application in which both the voltage output and current output are available—one at a time—on one pin, thus reducing the number of screw connections required. There is no conflict with tying the two output pins together because only the voltage output or the current output can be enabled at any one time.

The design provides for a HART-enabled current output, with the HART capability provided by the AD5700/AD5700-1 HART modem, the industry’s lowest power and smallest footprint HART-compliant IC modem. For additional space-savings, the AD5755-1 offers a 0.5% precision internal oscillator. The HART\_OUT signal from the AD5700 is attenuated and ac-coupled into the CHARTx pin of the AD5755-1. Such a configuration results in

the AD5700 HART modem output modulating the 4 mA to 20 mA analog current without affecting the dc level of the current. This circuit adheres to the HART physical layer specifications as defined by the HART Communication Foundation.

For transient overvoltage protection, a 24 V transient voltage suppressor (TVS) is placed on the  $I_{OUT}/V_{OUT}$  connection. For added protection, clamping diodes are connected from the  $I_{OUT\_X}/V_{OUT\_X}$  pin to the  $AV_{DD}$  and  $AV_{SS}$  power supply pins. A 5 k $\Omega$  current limiting resistor is also placed in series with the  $+V_{SENSE\_X}$  input. This is to limit the current to an acceptable level during a transient event. The recommended external band-pass filter for the AD5700 HART modem includes a 150 k $\Omega$  resistor, which limits current to a sufficiently low level to adhere to intrinsic safety requirements. In this case, the input has higher transient voltage protection and, therefore, does not require additional protection circuitry, even in the most demanding of industrial environments.

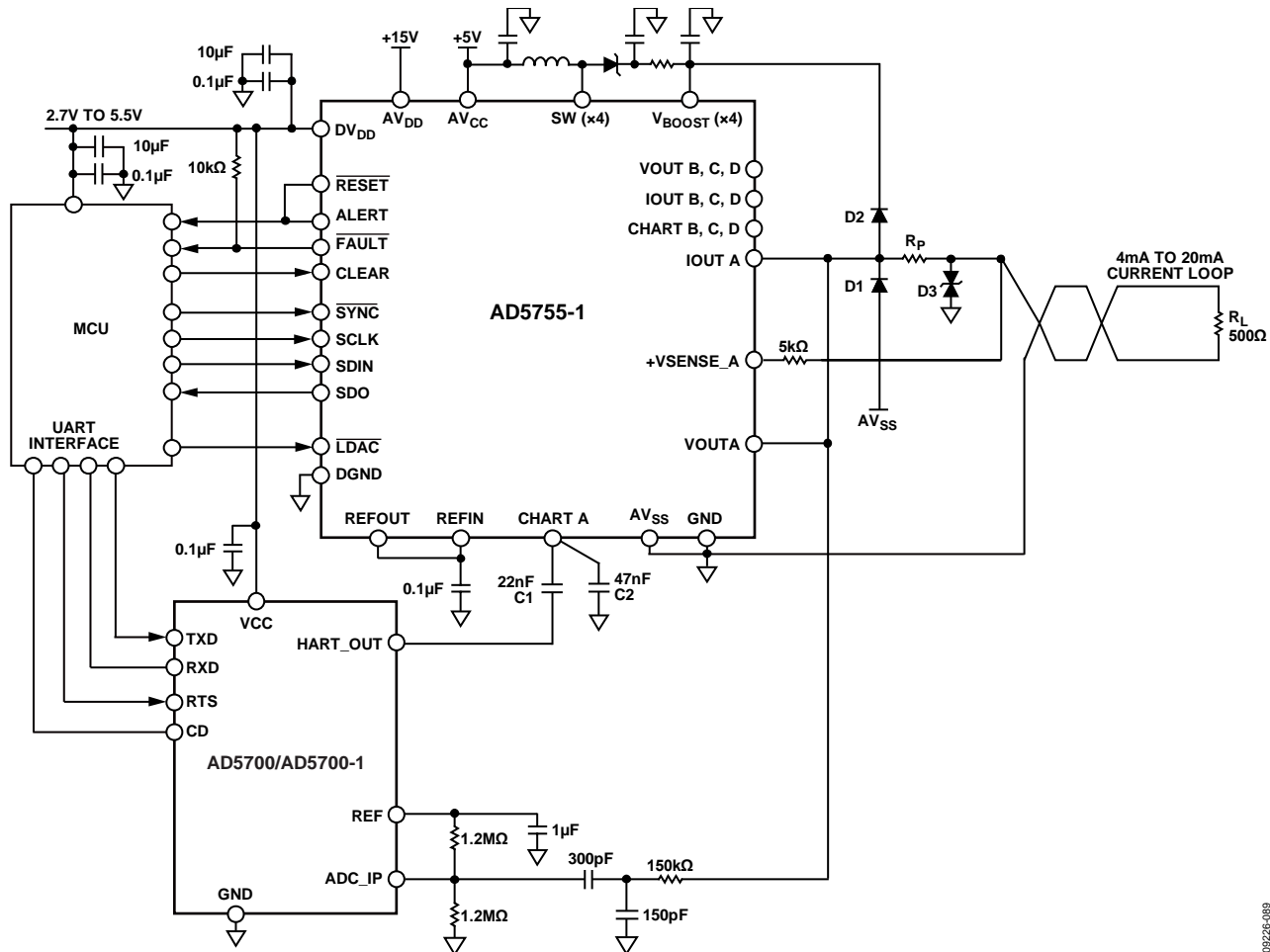
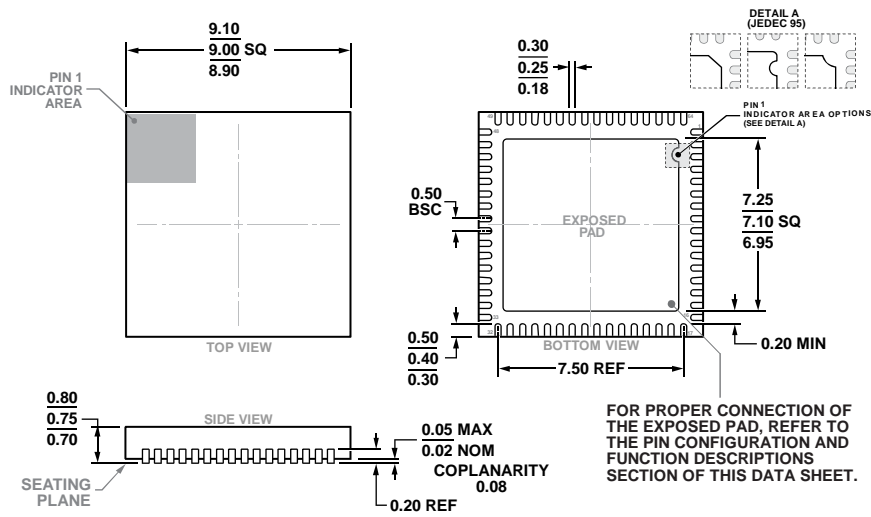

Figure 90. AD5755-1 in HART Configuration

08226-089

OUTLINE DIMENSIONS



COMPLIANT TO JEDEC STANDARDS MO-220-WMMD-4

Figure 91. 64-Lead Lead Frame Chip Scale Package [LFCSP]  
9 mm × 9 mm Body and 0.75 mm Package Height  
(CP-64-12)  
Dimensions shown in millimeters

ORDERING GUIDE

Model <sup>1</sup>	Resolution (Bits)	Temperature Range	Package Description	Package Option
AD5755-1ACPZ	16	−40°C to +105°C	64-Lead Lead Frame Chip Scale Package [LFCSP]	CP-64-12
AD5755-1ACPZ-REEL7	16	−40°C to +105°C	64-Lead Lead Frame Chip Scale Package [LFCSP]	CP-64-12
EVAL-AD5755-1SDZ			Evaluation Board	

<sup>1</sup> Z = RoHS Compliant Part.