

REVISIONS

LTR	DESCRIPTION	DATE (YR-MO-DA)	APPROVED
A	Changes in accordance with NOR 5962-R064-93. - drw	93-01-11	Michael A. Frye
B	Update drawing to current requirements. Editorial changes throughout. - drw	02-09-04	Raymond Monnin
C	Redrawn. Update paragraphs to MIL-PRF-38535 requirements. - drw	15-02-05	Charles F. Saffle

THE ORIGINAL FIRST SHEET OF THIS DRAWING HAS BEEN REPLACED.



REV																				
SHEET																				
REV																				
SHEET																				
REV STATUS	REV	C	C	C	C	C	C	C	C	C	C	C	C	C	C	C				
OF SHEETS	SHEET	1	2	3	4	5	6	7	8	9	10	11	12							

PMIC N/A	PREPARED BY Gary Zahn	<p align="center">DLA LAND AND MARITIME COLUMBUS, OHIO 43218-3990 http://www.landandmaritime.dla.mil</p>		
<p align="center">STANDARD MICROCIRCUIT DRAWING</p> <p>THIS DRAWING IS AVAILABLE FOR USE BY ALL DEPARTMENTS AND AGENCIES OF THE DEPARTMENT OF DEFENSE</p>	CHECKED BY Charles E. Besore			
	APPROVED BY William K. Heckman			
	DRAWING APPROVAL DATE 89-08-08			
AMSC N/A	REVISION LEVEL C	SIZE A	CAGE CODE 67268	5962-88765
		SHEET 1 OF 12		

1. SCOPE

1.1 Scope. This drawing describes device requirements for MIL-STD-883 compliant, non-JAN class level B microcircuits in accordance with MIL-PRF-38535, appendix A.

1.2 Part or Identifying Number (PIN). The complete PIN is as shown in the following example:

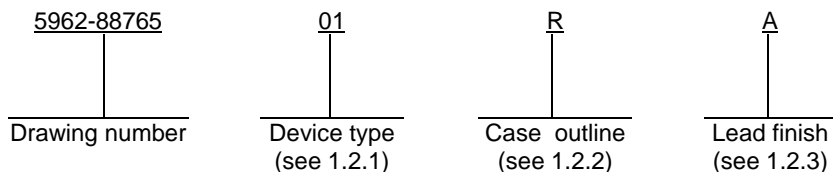

1.2.1 Device types. The device types identify the circuit function as follows:

<u>Device type</u>	<u>Generic number</u>	<u>Circuit function</u>	<u>Relative accuracy</u>
01	7549S	Dual, CMOS, 12-bit DAC	±1.0 LSB
02	7549T	Dual, CMOS, 12-bit DAC	±0.5 LSB

1.2.2 Case outline. The case outline is as designated in MIL-STD-1835 as follows:

<u>Outline letter</u>	<u>Descriptive designator</u>	<u>Terminals</u>	<u>Package style</u>
R	GDIP1-T20 or CDIP2-T20	20	dual-in-line

1.2.3 Lead finish. The lead finish is as specified in MIL-PRF-38535, appendix A.

1.3 Absolute maximum ratings.

V _{DD} to DGND	-0.3 V dc to +17 V dc
V _{REFA} , V _{REFB} to AGND	±25 V dc
V _{RFBA} , V _{RFBB} to AGND	±25 V dc
Digital input to DGND	-0.3 V dc to V _{DD}
V _{PIN15} , V _{PIN17} to DGND	-0.3 V dc to V _{DD}
AGND to DGND	-0.3 V dc to V _{DD}
Storage temperature range	-65°C to +150°C
Lead temperature (soldering, 10 seconds)	+300°C
Power dissipation (P _D)	+450 mW <u>1/</u>
Thermal resistance, junction-to-case (θ _{JC})	See MIL-STD-1835
Thermal resistance, junction-to-ambient (θ _{JA})	+120°C/W
Junction temperature (T _J)	+175°C

1.4 Recommended operating conditions.

Supply voltage (V _{DD})	+14.25 V dc to +15.75 V dc
A-reference voltage (V _{REFA})	+10 V dc
B-reference voltage (V _{REFB})	+10 V dc
Ambient operating temperature range (T _A)	-55°C to +125°C

1/ Derate above T_A = +75°C at +6.0 mW/°C.

STANDARD MICROCIRCUIT DRAWING DLA LAND AND MARITIME COLUMBUS, OHIO 43218-3990	SIZE A		5962-88765
		REVISION LEVEL C	SHEET 2

2. APPLICABLE DOCUMENTS

2.1 Government specification, standards, and handbooks. The following specification, standards, and handbooks form a part of this drawing to the extent specified herein. Unless otherwise specified, the issues of these documents are those cited in the solicitation or contract.

DEPARTMENT OF DEFENSE SPECIFICATION

MIL-PRF-38535 - Integrated Circuits, Manufacturing, General Specification for.

DEPARTMENT OF DEFENSE STANDARDS

MIL-STD-883 - Test Method Standard Microcircuits.
 MIL-STD-1835 - Interface Standard Electronic Component Case Outlines.

DEPARTMENT OF DEFENSE HANDBOOKS

MIL-HDBK-103 - List of Standard Microcircuit Drawings.
 MIL-HDBK-780 - Standard Microcircuit Drawings.

(Copies of these documents are available online at <http://quicksearch.dla.mil> or from the Standardization Document Order Desk, 700 Robbins Avenue, Building 4D, Philadelphia, PA 19111-5094.)

2.2 Order of precedence. In the event of a conflict between the text of this drawing and the references cited herein, the text of this drawing takes precedence. Nothing in this document, however, supersedes applicable laws and regulations unless a specific exemption has been obtained.

3. REQUIREMENTS

3.1 Item requirements. The individual item requirements shall be in accordance with MIL-PRF-38535, appendix A for non-JAN class level B devices and as specified herein. Product built to this drawing that is produced by a Qualified Manufacturer Listing (QML) certified and qualified manufacturer or a manufacturer who has been granted transitional certification to MIL-PRF-38535 may be processed as QML product in accordance with the manufacturers approved program plan and qualifying activity approval in accordance with MIL-PRF-38535. This QML flow as documented in the Quality Management (QM) plan may make modifications to the requirements herein. These modifications shall not affect form, fit, or function of the device. These modifications shall not affect the PIN as described herein. A "Q" or "QML" certification mark in accordance with MIL-PRF-38535 is required to identify when the QML flow option is used.

3.2 Design, construction, and physical dimensions. The design, construction, and physical dimensions shall be as specified in MIL-PRF-38535, appendix A and herein.

3.2.1 Case outline. The case outline shall be in accordance with 1.2.2 herein.

3.2.2 Terminal connections. The terminal connections shall be as specified on figure 1.

3.2.3 Truth table. The truth table shall be as specified on figure 2.

3.3 Electrical performance characteristics. Unless otherwise specified herein, the electrical performance characteristics are as specified in table I and shall apply over the full ambient operating temperature range.

3.4 Electrical test requirements. The electrical test requirements shall be the subgroups specified in table II. The electrical tests for each subgroup are described in table I.

3.5 Marking. Marking shall be in accordance with MIL-PRF-38535, appendix A. The part shall be marked with the PIN listed in 1.2 herein. In addition, the manufacturer's PIN may also be marked. For packages where marking of the entire SMD PIN number is not feasible due to space limitations, the manufacturer has the option of not marking the "5962-" on the device.

3.5.1 Certification/compliance mark. A compliance indicator "C" shall be marked on all non-JAN devices built in compliance to MIL-PRF-38535, appendix A. The compliance indicator "C" shall be replaced with a "Q" or "QML" certification mark in accordance with MIL-PRF-38535 to identify when the QML flow option is used

STANDARD MICROCIRCUIT DRAWING DLA LAND AND MARITIME COLUMBUS, OHIO 43218-3990	SIZE A		5962-88765
		REVISION LEVEL C	SHEET 3

TABLE I. Electrical performance characteristics.

Test	Symbol	Conditions <u>1/</u> , <u>2/</u> -55°C ≤ T _A ≤ +125°C unless otherwise specified	Group A subgroups	Device type	Limits		Unit
					Min	Max	
Resolution	RES	Guaranteed minimum resolution	1, 2, 3	All	12		Bits
Relative accuracy	RA		1, 2, 3	01		±1.0	LSB
			1	02		±1.0	
			2, 3, 12			±0.5	
Differential nonlinearity	DNL	Guaranteed monotonic to 12-bits	1, 2, 3	All		±1.0	LSB
Gain error <u>3/</u>	A _E		1, 2, 3	01		±6.0	LSB
			1	02		±6.0	
			2, 3, 12			±3.0	
Supply rejection (ΔGain/ΔV _{DD})	PSRR	ΔV _{DD} = ±5.0%, full scale outputs	1	All		±0.01	%/%
			2, 3			±0.02	
Output leakage current	I _{OUTA}	DAC A loaded with all 0's	1	All		20	nA
			2, 3			250	
	I _{OUTB}	DAC B loaded with all 0's	1	All		20	nA
			2, 3			250	
Output current settling time to 0.01% of FSR <u>4/</u>	t _{SL}	I _{OUT} load = 100Ω, C _{EXT} = 13 pF, DAC output measured from falling edge of WR	4	All		1.5	μs
Feedthrough error, V _{REFA} to I _{OUTA} or V _{REFB} to I _{OUTB} <u>4/</u> , <u>5/</u>	FT	V _{REFA} = V _{REFB} = ±20 V _{pp} , 10 kHz sine wave, DAC register loaded with all 0's	4	All		-65	dB
Reference input resistance	R _{IN}		1, 2, 3	All	7.0	18	kΩ
Reference input resistance match (V _{REFA} /V _{REFB})	R _{MIN}		1, 2, 3	01		±3.0	%
			1	02		±3.0	
			2, 3, 12			±2.0	

See footnotes at end of table.

**STANDARD
MICROCIRCUIT DRAWING**
DLA LAND AND MARITIME
COLUMBUS, OHIO 43218-3990

SIZE
A

REVISION LEVEL
C

5962-88765

SHEET
4

TABLE I. Electrical performance characteristics - continued.

Test	Symbol	Conditions <u>1/</u> , <u>2/</u> -55°C ≤ T _A ≤ +125°C unless otherwise specified	Group A subgroups	Device type	Limits		Unit
					Min	Max	
Digital input high voltage	V _{IH}		1, 2, 3	All	2.4		V
Digital input low voltage	V _{IL}		1, 2, 3	All		0.8	V
Input leakage current	I _{IN}	V _{IN} = V _{DD}	1	All		±1.0	μA
			2, 3			±10	
Input capacitance <u>4/</u>	C _{IN}		4	All		7.0	pF
Analog output capacitance <u>4/</u>	C _{OUTA}	DAC A = all 0's	4	All		80	pF
		DAC A = all 1's				160	
Analog output capacitance <u>4/</u>	C _{OUTB}	DAC B = all 0's	4	All		80	pF
		DAC B = all 1's				160	
Functional test		See 4.3.1c	7, 8	All			
Address valid to write setup time	t _{AWS}	See figure 3	9	All	50		ns
			10, 11		110		
Address valid to write hold time	t _{AWH}	See figure 3	9, 10, 11	All	0		ns
Data setup time	t _{DS}	See figure 3	9	All	180		ns
			10, 11		240		
Data hold time	t _{DH}	See figure 3	9, 10, 11	All	5		ns
Chip select or update to write setup time	t _{CWS}	See figure 3	9, 10, 11	All	20		ns
Chip select or update to write hold time	t _{CWH}	See figure 3	9, 10, 11	All	0		ns
Write pulse width	t _{WR}	See figure 3	9	All	170		ns
			10, 11		250		

See footnotes at end of table.

STANDARD MICROCIRCUIT DRAWING DLA LAND AND MARITIME COLUMBUS, OHIO 43218-3990	SIZE A		5962-88765
		REVISION LEVEL C	SHEET 5

TABLE I. Electrical performance characteristics - continued.

Test	Symbol	Conditions <u>1/</u> , <u>2/</u> -55°C ≤ T _A ≤ +125°C unless otherwise specified	Group A subgroups	Device type	Limits		Unit
					Min	Max	
Clear pulse width	t _{CLR}	See figure 3	9	All	170		ns
			10, 11		250		
Supply current	I _{DD}		1, 2, 3	All		5.0	mA

- 1/ V_{REFA} = V_{REFB} = +10 V, V_{PIN15} = V_{PIN16} = V_{PIN17} = 0 V unless otherwise specified. All tests are guaranteed over a supply voltage range of V_{DD} = 15 V ±5.0%, however, all measurements are made at V_{DD} = +15 V unless otherwise specified.
- 2/ Subgroups 10 and 11, if not tested, shall be guaranteed to the limits specified in table I.
- 3/ Measured using internal feedback resistor and includes effects of leakage current and gain temperature coefficient.
- 4/ Subgroup 4 (t_{SL}, FT, C_{IN}, C_{OUTA} and C_{OUTB} measurements) shall be measured only for the initial test and after process or design changes which may affect these tests.
- 5/ Feedthrough can be further reduced by connecting the metal lid to ground.

**STANDARD
MICROCIRCUIT DRAWING**
DLA LAND AND MARITIME
COLUMBUS, OHIO 43218-3990

SIZE
A

5962-88765









REVISION LEVEL
C

SHEET
6

Device types	All
Case outline	R
Terminal number	Terminal symbol
1	DB3
2	DB2
3	DB1
4	DB0
5	$\overline{\text{UPD}}$
6	A2
7	A1
8	A0
9	$\overline{\text{CS}}$
10	$\overline{\text{WR}}$
11	CLR
12	DGND
13	V _{REFB}
14	R _{FBB}
15	I _{OUTB}
16	AGND
17	I _{OUTA}
18	R _{FBA}
19	V _{REFA}
20	V _{DD}

FIGURE 1. Terminal connections.

STANDARD MICROCIRCUIT DRAWING DLA LAND AND MARITIME COLUMBUS, OHIO 43218-3990	SIZE A		5962-88765
		REVISION LEVEL C	SHEET 7

CLR	$\overline{\text{UPD}}$	$\overline{\text{CS}}$	$\overline{\text{WR}}$	A2	A1	A0	Function
0	X	X	1	X	X	X	No data transfer
0	1	1	X	X	X	X	No data transfer
1	X	X	X	X	X	X	All register cleared
0	1	0		0	0	0	DAC A low nibble register loaded from data bus
0	1	0		0	0	1	DAC A mid nibble register loaded from data bus
0	1	0		0	1	0	DAC A high nibble register loaded from data bus
0	1	0		0	1	1	DAC A register loaded from input registers
0	1	0		1	0	0	DAC B low nibble register loaded from data bus
0	1	0		1	0	1	DAC B mid nibble register loaded from data bus
0	1	0		1	1	0	DAC B high nibble register loaded from data bus
0	1	0		1	1	1	DAC B register loaded from input registers
0	0	1		X	X	X	DAC A, DAC B registers updated simultaneously from input registers

0 = Logic low level
1 = Logic high level
X = Don't care

FIGURE 2. Truth table.

STANDARD MICROCIRCUIT DRAWING DLA LAND AND MARITIME COLUMBUS, OHIO 43218-3990	SIZE A		5962-88765
		REVISION LEVEL C	SHEET 8

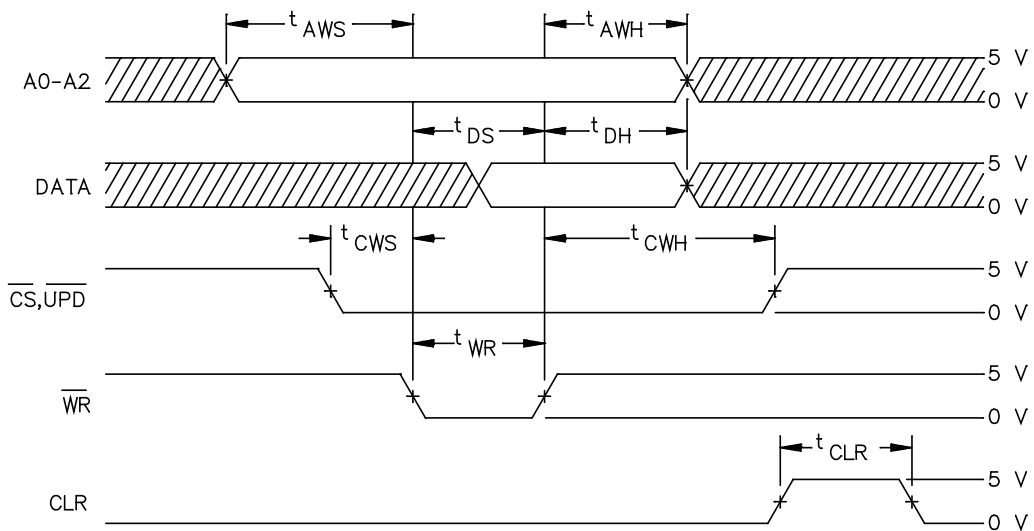

Notes:

1. All input signal rise and fall times are measured from 10% to 90% of +5.0 V, $t_r = t_f = 20$ ns.
2. Timing measurement reference level is $\frac{V_{IH} + V_{IL}}{2}$

FIGURE 3. Timing diagram.

**STANDARD
MICROCIRCUIT DRAWING**
DLA LAND AND MARITIME
COLUMBUS, OHIO 43218-3990

SIZE
A

5962-88765

REVISION LEVEL
C

SHEET
9

3.6 Certificate of compliance. A certificate of compliance shall be required from a manufacturer in order to be listed as an approved source of supply in MIL-HDBK-103 (see 6.6 herein). The certificate of compliance submitted to DLA Land and Maritime -VA prior to listing as an approved source of supply shall affirm that the manufacturer's product meets the requirements of MIL-PRF-38535, appendix A and the requirements herein.

3.7 Certificate of conformance. A certificate of conformance as required in MIL-PRF-38535, appendix A shall be provided with each lot of microcircuits delivered to this drawing.

3.8 Notification of change. Notification of change to DLA Land and Maritime -VA shall be required for any change that affects this drawing.

3.9 Verification and review. DLA Land and Maritime, DLA Land and Maritime's agent, and the acquiring activity retain the option to review the manufacturer's facility and applicable required documentation. Offshore documentation shall be made available onshore at the option of the reviewer.

4. VERIFICATION

4.1 Sampling and inspection. Sampling and inspection procedures shall be in accordance with MIL-PRF-38535, appendix A.

4.2 Screening. Screening shall be in accordance with method 5004 of MIL-STD-883, and shall be conducted on all devices prior to quality conformance inspection. The following additional criteria shall apply:

- a. Burn-in test, method 1015 of MIL-STD-883.
 - (1) Test condition A, B, C, or D. The test circuit shall be maintained by the manufacturer under document revision level control and shall be made available to the preparing or acquiring activity upon request. The test circuit shall specify the inputs, outputs, biases, and power dissipation, as applicable, in accordance with the intent specified in method 1015 of MIL-STD-883.
 - (2) $T_A = +125^{\circ}\text{C}$, minimum.
- b. Interim and final electrical test parameters shall be as specified in table II herein, except interim electrical parameter tests prior to burn-in are optional at the discretion of the manufacturer.

STANDARD MICROCIRCUIT DRAWING DLA LAND AND MARITIME COLUMBUS, OHIO 43218-3990	SIZE A		5962-88765
		REVISION LEVEL C	SHEET 10

TABLE II. Electrical test requirements.

MIL-STD-883 test requirements	Subgroups (in accordance with MIL-STD-883, method 5005, table I)
Interim electrical parameters (method 5004)	---
Final electrical test parameters (method 5004)	1*, 2, 3, 7, 12
Group A test requirements (method 5005)	1, 2, 3, 4**, 7, 8, 9, 10***, 11***, 12
Groups C and D end-point electrical parameters (method 5005)	1

* PDA applies to subgroup 1.

** See 4.3.1e.

*** Subgroups 10 and 11, if not tested, shall be guaranteed to the limits specified in table I.

4.3 Quality conformance inspection. Quality conformance inspection shall be in accordance with method 5005 of MIL-STD-883 including groups A, B, C, and D inspections. The following additional criteria shall apply.

4.3.1 Group A inspection.

- a. Tests shall be as specified in table II herein.
- b. Subgroups 5 and 6 in table I, method 5005 of MIL-STD-883 shall be omitted.
- c. Subgroups 7 and 8 shall include verification of the truth table.
- d. Subgroup 12 test is used for grading and part selection at $T_A = +25^\circ\text{C}$ and is not included in PDA calculations.
- e. Subgroup 4 (t_{SL} , FT, C_{IN} , C_{OUTA} and C_{OUTB} measurements) shall be measured only for the initial test and after process or design changes which may affect these capacitance measurements.

4.3.2 Groups C and D inspections.

- a. End-point electrical parameters shall be as specified in table II herein.
- b. Steady-state life test conditions, method 1005 of MIL-STD-883.
 - (1) Test condition A, B, C, or D. The test circuit shall be maintained by the manufacturer under document revision level control and shall be made available to the preparing or acquiring activity upon request. The test circuit shall specify the inputs, outputs, biases, and power dissipation, as applicable, in accordance with the intent specified in method 1005 of MIL-STD-883.
 - (2) $T_A = +125^\circ\text{C}$, minimum.
 - (3) Test duration: 1,000 hours, except as permitted by method 1005 of MIL-STD-883.

STANDARD MICROCIRCUIT DRAWING DLA LAND AND MARITIME COLUMBUS, OHIO 43218-3990	SIZE A		5962-88765
		REVISION LEVEL C	SHEET 11

5. PACKAGING

5.1 Packaging requirements. The requirements for packaging shall be in accordance with MIL-PRF-38535, appendix A.

6. NOTES

6.1 Intended use. Microcircuits conforming to this drawing are intended for use for Government microcircuit applications (original equipment), design applications, and logistics purposes.

6.2 Replaceability. Microcircuits covered by this drawing will replace the same generic device covered by a contractor-prepared specification or drawing.

6.3 Configuration control of SMD's. All proposed changes to existing SMD's will be coordinated with the users of record for the individual documents. This coordination will be accomplished using DD Form 1692, Engineering Change Proposal.

6.4 Record of users. Military and industrial users shall inform DLA Land and Maritime when a system application requires configuration control and the applicable SMD to that system. DLA Land and Maritime will maintain a record of users and this list will be used for coordination and distribution of changes to the drawings. Users of drawings covering microelectronics devices (FSC 5962) should contact DLA Land and Maritime-VA, telephone (614) 692-8108.

6.5 Comments. Comments on this drawing should be directed to DLA Land and Maritime-VA, Columbus, Ohio 43218-3990, or telephone (614) 692-0540.

6.6 Approved sources of supply. Approved sources of supply are listed in MIL-HDBK-103 and QML-38535. The vendors listed in MIL-HDBK-103 and QML-38535 have agreed to this drawing and a certificate of compliance (see 3.6 herein) has been submitted to and accepted by DLA Land and Maritime-VA.

STANDARD MICROCIRCUIT DRAWING DLA LAND AND MARITIME COLUMBUS, OHIO 43218-3990	SIZE A		5962-88765
		REVISION LEVEL C	SHEET 12

STANDARD MICROCIRCUIT DRAWING BULLETIN

DATE: 15-02-05

Approved sources of supply for SMD 5962-88765 are listed below for immediate acquisition information only and shall be added to MIL-HDBK-103 and QML-38535 during the next revision. MIL-HDBK-103 and QML-38535 will be revised to include the addition or deletion of sources. The vendors listed below have agreed to this drawing and a certificate of compliance has been submitted to and accepted by DLA Land and Maritime-VA. This information bulletin is superseded by the next dated revision of MIL-HDBK-103 and QML-38535. DLA Land and Maritime maintains an online database of all current sources of supply at <http://www.landandmaritime.dla.mil/Programs/Smcr/>.

Standard microcircuit drawing PIN <u>1/</u>	Vendor CAGE number	Vendor similar PIN <u>2/</u>
5962-8876501RA	24355	AD7549SQ/883B
5962-8876502RA	24355	AD7549TQ/883B

1/ The lead finish shown for each PIN representing a hermetic package is the most readily available from the manufacturer listed for that part. If the desired lead finish is not listed contact the vendor to determine its availability.

2/ Caution. Do not use this number for item acquisition. Items acquired to this number may not satisfy the performance requirements of this drawing.

Vendor CAGE number

24355

Vendor name and address

Analog Devices
 Rt 1 Industrial Park
 PO Box 9106
 Norwood, MA 02062
 Point of contact: Raheen Business Park
 Limerick, Ireland

The information contained herein is disseminated for convenience only and the Government assumes no liability whatsoever for any inaccuracies in the information bulletin.