



M80186
HIGH INTEGRATION 16-BIT MICROPROCESSOR
 MILITARY

T-49-17-15

- **Integrated Feature Set**
 - Enhanced M8086-2 CPU
 - Clock Generator
 - 2 Independent, High-Speed DMA Channels
 - Programmable Interrupt Controller
 - 3 Programmable 16-bit Timers
 - Programmable Memory and Peripheral Chip-Select Logic
 - Programmable Wait State Generator
 - Local Bus Controller
- **Available in 8 MHz (M80186-8) and 6 MHz (M80186-6) Versions**
- **High-Performance Processor**
 - 2 Times the Performance of the Standard M8086
 - 4 MByte/Sec Bus Bandwidth Interface
- **Direct Addressing Capability to 1 MByte of Memory**
- **Completely Object Code Compatible with All Existing M8086, M8088 Software**
 - 10 New Instruction Types
- **Complete System Development Support**
 - Development Software; Assembler, PL/M, Pascal, Fortran, and System Utilities
 - In-Circuit-Emulator (I²CICE™-186)
 - IRMX™ 86, 88 Compatible (80130 OSF)
- **High Performance Numerical Coprocessing Capability Through M8087 Interface**
- **Military Temperature Range:**
 - 55°C to + 125°C (T_C)

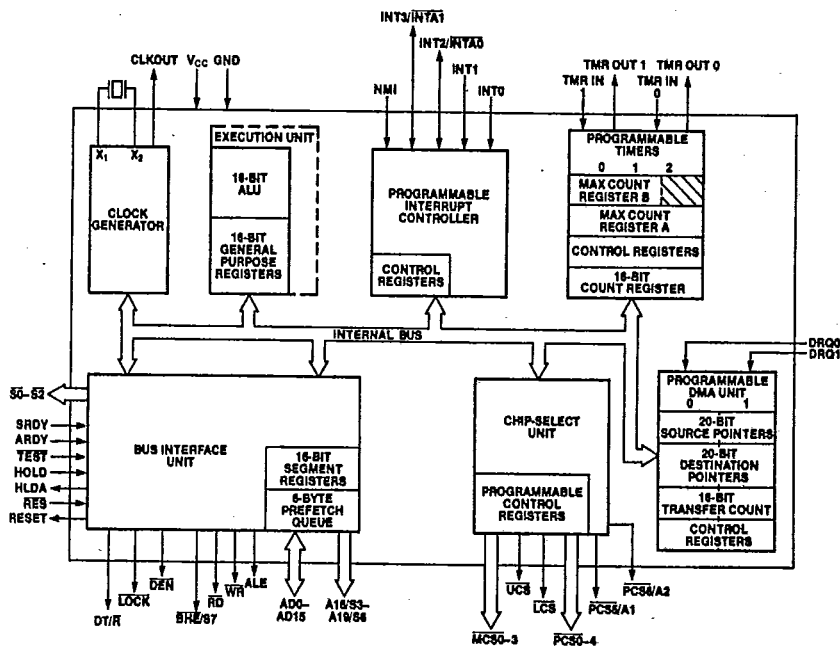

Figure 1. M80186 Block Diagram

270045-1



T-49-17-15

The Intel M80186 is a highly integrated 16-bit microprocessor. The M80186 effectively combines 15-20 of the most common M8086 system components onto one. The M80186 provides two times greater throughput than the standard 5 MHz M8086. The M80186 is upward compatible with M8086 and M8088 software and adds 10 new instruction types to the existing set.

PIN GRID ARRAY

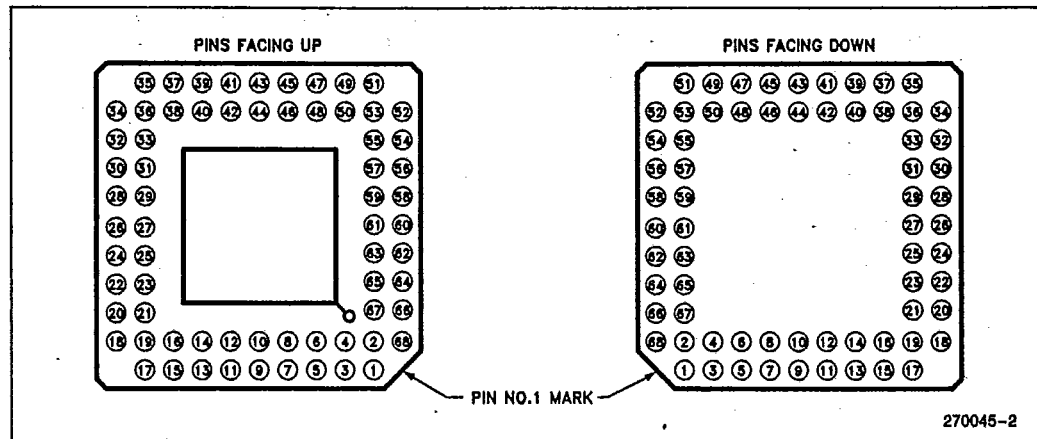
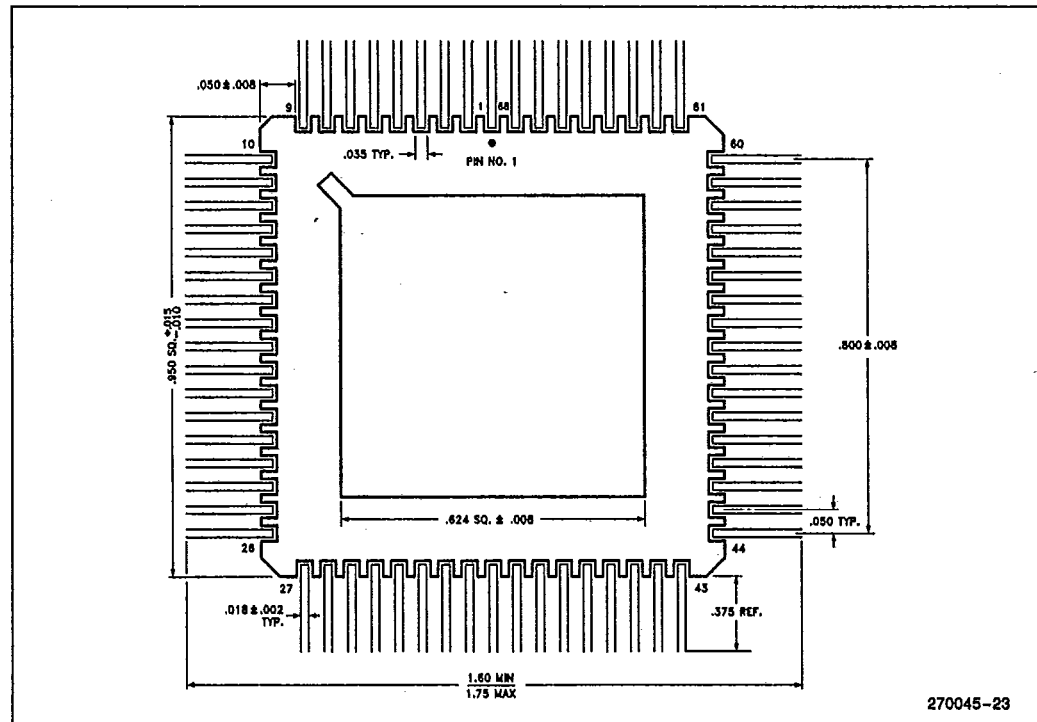

Figure 2. M80186 Pinout Diagram

PACKAGING INFORMATION All dimensions in inches



68-Lead Ceramic Quad Pack



T-49-17-15

Table 1. M80186 Pin Description

| Symbol | PGA | CQP | Type | Name and Function | | | | | | |
|---|----------------------|----------------------|------------------|---|--|-----|------|----|-----------------|-----------|
| V _{CC} , V _{CC} | 9, 43 | 1, 35 | PWR | SYSTEM POWER: +5 volt power supply. | | | | | | |
| V _{SS} , V _{SS} | 26, 60 | 52, 18 | PWR | System Ground. | | | | | | |
| RESET | 57 | 21 | O | Reset Output indicates that the M80186 CPU is being reset, and can be used as a system reset. It is active HIGH, synchronized with the processor clock, and lasts an integer number of clock periods corresponding to the length of the RES signal. | | | | | | |
| X1, X2 | 59, 58 | 19, 20 | I | Crystal Inputs, X1 and X2, provide an external connection for a fundamental mode parallel resonant crystal for the internal crystal oscillator. X1 can interface to an external clock instead of a crystal. In this case, minimize the capacitance on X2 or drive X2 with complemented X1. The input or oscillator frequency is internally divided by two to generate the clock signal (CLKOUT). | | | | | | |
| CLKOUT | 56 | 22 | O | Clock Output provides the system with a 50% duty cycle waveform. All device pin timings are specified relative to CLKOUT. CLKOUT has sufficient MOS drive capabilities for the M8087 Numeric Processor Extension. | | | | | | |
| RESET | 24 | 54 | I | System Reset causes the M80186 to immediately terminate its present activity, clear the internal logic, and enter a dormant state. This signal may be asynchronous to the M80186 clock. The M80186 begins fetching instructions approximately 7 clock cycles after RES is returned HIGH. RES is required to be LOW for greater than 4 clock cycles and is internally synchronized. For proper initialization, the LOW-to-HIGH transition of RES must occur no sooner than 50 microseconds after power up. This input is provided with a Schmitt-trigger to facilitate power-on RES generation via an RC network. When RES occurs, the M80186 will drive the status lines to an inactive level for one clock, and then tri-state them. | | | | | | |
| TEST | 47 | 31 | I | TEST is examined by the WAIT instruction. If the TEST input is HIGH when "WAIT" execution begins, instruction execution will suspend. TEST will be resampled until it goes LOW, at which time execution will resume. If interrupts are enabled while the M80186 is waiting for TEST, interrupts will be serviced. This input is synchronized internally. | | | | | | |
| TMR IN 0, TMR IN 1 | 20 21 | 58 57 | I I | Timer Inputs are used either as clock or control signals, depending upon the programmed timer mode. These inputs are active HIGH (or LOW-to-HIGH transitions are counted) and internally synchronized. | | | | | | |
| TMR OUT 0, TMR OUT 1 | 22 23 | 56 55 | O O | Timer outputs are used to provide single pulse or continuous waveform generation, depending upon the timer mode selected. | | | | | | |
| DRQ0 DRQ1 | 18 19 | 60 59 | I I | DMA Request is driven HIGH by an external device when it desires that a DMA channel (Channel 0 or 1) perform a transfer. These signals are active HIGH, level-triggered, and internally synchronized. | | | | | | |
| NMI | 46 | 32 | I | Non-Maskable Interrupt is an edge-triggered input which causes a type 2 interrupt. NMI is not maskable internally. A transition from a LOW to HIGH initiates the interrupt at the next instruction boundary. NMI is latched internally. An NMI duration of one clock or more will guarantee service. This input is internally synchronized. | | | | | | |
| INT0, INT1 INT2/INTA0 INT3/INTA1 | 45, 44 42 41 | 33, 34 36 37 | I I/O I/O | Maskable Interrupt Requests can be requested by strobing one of these pins. When configured as inputs, these pins are active HIGH. Interrupt Requests are synchronized internally. INT2 and INT3 may be configured via software to provide active-LOW interrupt-acknowledge output signals. All interrupt inputs may be configured via software to be either edge- or level-triggered. To ensure recognition, all interrupt requests must remain active until the interrupt is acknowledged. When iRMX mode is selected, the function of these pins changes (see Interrupt Controller section of this data sheet). | | | | | | |
| A19/S6, A18/S5, A17/S4, A16/S3 | 65 66 67 68 | 13 12 11 10 | O O O O | Address Bus Outputs (16-19) and Bus Cycle Status (3-6) reflect the four most significant address bits during T ₁ . These signals are active HIGH. During T ₂ , T ₃ , T _W , and T ₄ , status information is available on these lines as encoded below: | | | | | | |
| | | | | <table border="1"> <thead> <tr> <th></th> <th>Low</th> <th>High</th> </tr> </thead> <tbody> <tr> <td>S6</td> <td>Processor Cycle</td> <td>DMA Cycle</td> </tr> </tbody> </table> | | Low | High | S6 | Processor Cycle | DMA Cycle |
| | Low | High | | | | | | | | |
| S6 | Processor Cycle | DMA Cycle | | | | | | | | |
| | | | | S3, S4, and S5 are defined as LOW during T ₂ -T ₄ . | | | | | | |



T-49-17-15

Table 1. M80186 Pin Description (Continued)

| Symbol | PGA | CQP | Type | Name and Function | | | | | | | | | | | | | | | | | | |
|----------------------|----------|--|------|---|----------------------|-----|-----------------|-----------|----------|--------------------|---|---|--|---|---|--|---|---|---|---|---|----------|
| AD15 | 1 | 9 | I/O | Address/Data Bus (0-15) signals constitute the time multiplexed memory or I/O address (T ₁) and data (T ₂ , T ₃ , T _W , and T ₄) bus. The bus is active HIGH. A ₀ is analogous to BHE for the lower byte of the data bus, pins D ₇ through D ₀ . It is LOW during T ₁ when a byte is to be transferred onto the lower portion of the bus in memory or I/O operations. | | | | | | | | | | | | | | | | | | |
| AD14 | 3 | 7 | | | | | | | | | | | | | | | | | | | | |
| AD13 | 5 | 5 | | | | | | | | | | | | | | | | | | | | |
| AD12 | 7 | 3 | | | | | | | | | | | | | | | | | | | | |
| AD11 | 10 | 68 | | | | | | | | | | | | | | | | | | | | |
| AD10 | 12 | 66 | | | | | | | | | | | | | | | | | | | | |
| AD9 | 14 | 64 | | | | | | | | | | | | | | | | | | | | |
| AD8 | 16 | 62 | | | | | | | | | | | | | | | | | | | | |
| AD7 | 2 | 8 | | | | | | | | | | | | | | | | | | | | |
| AD6 | 4 | 6 | | | | | | | | | | | | | | | | | | | | |
| AD5 | 6 | 4 | | | | | | | | | | | | | | | | | | | | |
| AD4 | 8 | 2 | | | | | | | | | | | | | | | | | | | | |
| AD3 | 11 | 67 | | | | | | | | | | | | | | | | | | | | |
| AD2 | 13 | 65 | | | | | | | | | | | | | | | | | | | | |
| AD1 | 15 | 63 | | | | | | | | | | | | | | | | | | | | |
| AD0 | 17 | 61 | | | | | | | | | | | | | | | | | | | | |
| BHE/S7 | 64 | 14 | O | <p>During T₁ the Bus High Enable signal should be used to determine if data is to be enabled onto the most significant half of the data bus; pins D₁₅-D₈. BHE is LOW during T₁ for read, write, and interrupt acknowledge cycles when a byte is to be transferred on the higher half of the bus. The S₇ status information is available during T₂, T₃, and T₄. S₇ is logically equivalent to BHE. The signal is active LOW, and is tristated OFF during bus HOLD.</p> <table border="1"> <thead> <tr> <th colspan="3">BHE and A0 Encodings</th> </tr> <tr> <th>BHE Value</th> <th>A0 Value</th> <th>Function</th> </tr> </thead> <tbody> <tr> <td>0</td> <td>0</td> <td>Word Transfer</td> </tr> <tr> <td>0</td> <td>1</td> <td>Byte Transfer on upper half of data bus (D₁₅-D₈)</td> </tr> <tr> <td>1</td> <td>0</td> <td>Byte Transfer on lower half of data bus (D₇-D₀)</td> </tr> <tr> <td>1</td> <td>1</td> <td>Reserved</td> </tr> </tbody> </table> | BHE and A0 Encodings | | | BHE Value | A0 Value | Function | 0 | 0 | Word Transfer | 0 | 1 | Byte Transfer on upper half of data bus (D ₁₅ -D ₈) | 1 | 0 | Byte Transfer on lower half of data bus (D ₇ -D ₀) | 1 | 1 | Reserved |
| BHE and A0 Encodings | | | | | | | | | | | | | | | | | | | | | | |
| BHE Value | A0 Value | Function | | | | | | | | | | | | | | | | | | | | |
| 0 | 0 | Word Transfer | | | | | | | | | | | | | | | | | | | | |
| 0 | 1 | Byte Transfer on upper half of data bus (D ₁₅ -D ₈) | | | | | | | | | | | | | | | | | | | | |
| 1 | 0 | Byte Transfer on lower half of data bus (D ₇ -D ₀) | | | | | | | | | | | | | | | | | | | | |
| 1 | 1 | Reserved | | | | | | | | | | | | | | | | | | | | |
| ALE/QS0 | 61 | 17 | O | <p>Address Latch Enable/Queue Status 0 is provided by the M80186 to latch the address into the M8282/M8283 address latches. ALE is active HIGH. Addresses are guaranteed to be valid on the trailing edge of ALE. The ALE rising edge is generated off the rising edge of the CLKOUT immediately preceding T₁ of the associated bus cycle, effectively one-half clock cycle earlier than in the standard M8086. The trailing edge is generated off the CLKOUT rising edge in T₁ as in the M8086. Note that ALE is never floated.</p> | | | | | | | | | | | | | | | | | | |
| WR/QS1 | 63 | 15 | O | <p>Write Strobe/Queue Status 1 indicates that the data on the bus is to be written into a memory or an I/O device. WR is active for T₂, T₃, and T_W of any write cycle. It is active LOW, and floats during "HOLD." It is driven HIGH for one clock during Reset, and then floated. When the M80186 is in queue status mode, the ALE/QS0 and WR/QS1 pins provide information about processor/instruction queue interaction.</p> <table border="1"> <thead> <tr> <th>QS1</th> <th>QS0</th> <th>Queue Operation</th> </tr> </thead> <tbody> <tr> <td>0</td> <td>0</td> <td>No queue operation</td> </tr> <tr> <td>0</td> <td>1</td> <td>First opcode byte fetched from the queue</td> </tr> <tr> <td>1</td> <td>1</td> <td>Subsequent byte fetched from the queue</td> </tr> <tr> <td>1</td> <td>0</td> <td>Empty the queue</td> </tr> </tbody> </table> | QS1 | QS0 | Queue Operation | 0 | 0 | No queue operation | 0 | 1 | First opcode byte fetched from the queue | 1 | 1 | Subsequent byte fetched from the queue | 1 | 0 | Empty the queue | | | |
| QS1 | QS0 | Queue Operation | | | | | | | | | | | | | | | | | | | | |
| 0 | 0 | No queue operation | | | | | | | | | | | | | | | | | | | | |
| 0 | 1 | First opcode byte fetched from the queue | | | | | | | | | | | | | | | | | | | | |
| 1 | 1 | Subsequent byte fetched from the queue | | | | | | | | | | | | | | | | | | | | |
| 1 | 0 | Empty the queue | | | | | | | | | | | | | | | | | | | | |



T-49-17-15

Table 1. M80186 Pin Description (Continued)

| Symbol | PGA | CQP | Type | Name and Function | | | | | | | | | | | | | | | | | | | | | | | | | | | | | | | | | | | | | | | | |
|---|-----------------|-----------------|------------------------|---|-------------------------------------|--|--|--|-----------------|-----------------|-----------------|---------------------|---|---|---|-----------------------|---|---|---|----------|---|---|---|-----------|---|---|---|------|---|---|---|-------------------|---|---|---|-----------------------|---|---|---|----------------------|---|---|---|------------------------|
| RD/QSMD | 62 | 16 | O | Read Strobe indicates that the M80186 is performing a memory or I/O read cycle. \overline{RD} is active LOW for T_2 , T_3 , and T_W of any read cycle. It is guaranteed not to go LOW in T_2 until after the Address Bus is floated. \overline{RD} is active LOW, and floats during "HOLD". \overline{RD} is driven HIGH for one clock during Reset, and then the output driver is floated. A weak internal pull-up mechanism of the RD line holds it HIGH when the line is not driven. During RESET the pin is sampled to determine whether the M80186 should provide ALE, \overline{WR} and \overline{RD} , or if the Queue-Status should be provided. \overline{RD} should be connected to GND to provide Queue-Status data. | | | | | | | | | | | | | | | | | | | | | | | | | | | | | | | | | | | | | | | | |
| ARDY | 55 | 23 | I | Asynchronous Ready informs the M80186 that the addressed memory space or I/O device will complete a data transfer. The ARDY input pin will accept an asynchronous input, and is active HIGH. Only the rising edge is internally synchronized by the M80186. This means that the falling edge of ARDY must be synchronized to the M80186 clock. If connected to V_{CC} , no WAIT states are inserted. Asynchronous ready (ARDY) or synchronous ready (SRDY) must be active to terminate a bus cycle. If unused, this line should be tied LOW. | | | | | | | | | | | | | | | | | | | | | | | | | | | | | | | | | | | | | | | | |
| SRDY | 49 | 29 | I | Synchronous Ready must be synchronized externally to the M80186. The use of SRDY provides a relaxed system-timing specification on the Ready input. This is accomplished by eliminating the one-half clock cycle which is required for internally resolving the signal level when using the ARDY input. This line is active HIGH. If this line is connected to V_{CC} , no WAIT states are inserted. Asynchronous ready (ARDY) or synchronous ready (SRDY) must be active before a bus cycle is terminated. If unused, this line should be tied LOW. | | | | | | | | | | | | | | | | | | | | | | | | | | | | | | | | | | | | | | | | |
| LOCK | 48 | 30 | O | LOCK output indicates that other system bus masters are not to gain control of the system bus while LOCK is active LOW. The LOCK signal is requested by the LOCK prefix instruction and is activated at the beginning of the first data cycle associated with the instruction following the LOCK prefix. It remains active until the completion of the instruction following the LOCK prefix. No prefetches will occur while LOCK is asserted. When executing more than one LOCK instruction, always make sure there are 6 bytes of code between the end of the first LOCK instruction and the start of the second LOCK instruction. LOCK is active LOW, is driven HIGH for one clock during RESET, and then floated. | | | | | | | | | | | | | | | | | | | | | | | | | | | | | | | | | | | | | | | | |
| $\overline{S0}$ $\overline{S1}$ $\overline{S2}$ | 52 53 54 | 26 25 24 | O | <p>Bus cycle status $\overline{S0}$-$\overline{S2}$ are encoded to provide bus-transaction information:</p> <table border="1"> <thead> <tr> <th colspan="4">M80186 Bus Cycle Status Information</th> </tr> <tr> <th>$\overline{S2}$</th> <th>$\overline{S1}$</th> <th>$\overline{S0}$</th> <th>Bus Cycle Initiated</th> </tr> </thead> <tbody> <tr> <td>0</td> <td>0</td> <td>0</td> <td>Interrupt Acknowledge</td> </tr> <tr> <td>0</td> <td>0</td> <td>1</td> <td>Read I/O</td> </tr> <tr> <td>0</td> <td>1</td> <td>0</td> <td>Write I/O</td> </tr> <tr> <td>0</td> <td>1</td> <td>1</td> <td>Halt</td> </tr> <tr> <td>1</td> <td>0</td> <td>0</td> <td>Instruction Fetch</td> </tr> <tr> <td>1</td> <td>0</td> <td>1</td> <td>Read Data from Memory</td> </tr> <tr> <td>1</td> <td>1</td> <td>0</td> <td>Write Data to Memory</td> </tr> <tr> <td>1</td> <td>1</td> <td>1</td> <td>Passive (no bus cycle)</td> </tr> </tbody> </table> <p>The status pins float during "HOLD." $\overline{S2}$ may be used as a logical M/I/O indicator, and $\overline{S1}$ as a DT/\overline{R} indicator. The status lines are driven HIGH for one clock during Reset, and then floated until a bus cycle begins.</p> | M80186 Bus Cycle Status Information | | | | $\overline{S2}$ | $\overline{S1}$ | $\overline{S0}$ | Bus Cycle Initiated | 0 | 0 | 0 | Interrupt Acknowledge | 0 | 0 | 1 | Read I/O | 0 | 1 | 0 | Write I/O | 0 | 1 | 1 | Halt | 1 | 0 | 0 | Instruction Fetch | 1 | 0 | 1 | Read Data from Memory | 1 | 1 | 0 | Write Data to Memory | 1 | 1 | 1 | Passive (no bus cycle) |
| M80186 Bus Cycle Status Information | | | | | | | | | | | | | | | | | | | | | | | | | | | | | | | | | | | | | | | | | | | | |
| $\overline{S2}$ | $\overline{S1}$ | $\overline{S0}$ | Bus Cycle Initiated | | | | | | | | | | | | | | | | | | | | | | | | | | | | | | | | | | | | | | | | | |
| 0 | 0 | 0 | Interrupt Acknowledge | | | | | | | | | | | | | | | | | | | | | | | | | | | | | | | | | | | | | | | | | |
| 0 | 0 | 1 | Read I/O | | | | | | | | | | | | | | | | | | | | | | | | | | | | | | | | | | | | | | | | | |
| 0 | 1 | 0 | Write I/O | | | | | | | | | | | | | | | | | | | | | | | | | | | | | | | | | | | | | | | | | |
| 0 | 1 | 1 | Halt | | | | | | | | | | | | | | | | | | | | | | | | | | | | | | | | | | | | | | | | | |
| 1 | 0 | 0 | Instruction Fetch | | | | | | | | | | | | | | | | | | | | | | | | | | | | | | | | | | | | | | | | | |
| 1 | 0 | 1 | Read Data from Memory | | | | | | | | | | | | | | | | | | | | | | | | | | | | | | | | | | | | | | | | | |
| 1 | 1 | 0 | Write Data to Memory | | | | | | | | | | | | | | | | | | | | | | | | | | | | | | | | | | | | | | | | | |
| 1 | 1 | 1 | Passive (no bus cycle) | | | | | | | | | | | | | | | | | | | | | | | | | | | | | | | | | | | | | | | | | |



Table 1. M80186 Pin Description (Continued)

| Symbol | PGA | CQP | Type | Name and Function |
|---------------|------------------|------------------|------|---|
| HOLD (input) | 50 | 28 | I | HOLD indicates that another bus master is requesting the local bus. The HOLD input is active HIGH. HOLD may be asynchronous with respect to the M80186 clock. The M80186 will issue a HLDA (HIGH) in response to a HOLD request at the end of T ₄ or T ₁ . Simultaneous with the issuance of HLDA, the M80186 will float the local bus and control lines. After HOLD is detected as being LOW, the M80186 will lower HLDA. When the M80186 needs to run another bus cycle, it will again drive the local bus and control lines. |
| HLDA (output) | 51 | 27 | O | |
| UCS | 34 | 44 | O | Upper Memory Chip Select is an active LOW output whenever a memory reference is made to the defined upper portion (1K-256K block) of memory. This line is not floated during bus HOLD. The address range activating UCS is software programmable. |
| LCS | 33 | 45 | O | Lower Memory Chip Select is active LOW whenever a memory reference is made to the defined lower portion (1K-256K) of memory. This line is not floated during bus HOLD. The address range activating LCS is software programmable. |
| MCS0-3 | 38, 37 36, 35 | 40, 41 42, 43 | O | Mid-Range Memory Chip Select signals are active LOW when a memory reference is made to the defined mid-range portion of memory (8K-512K). These lines are not floated during bus HOLD. The address ranges activating MCS0-3 are software programmable. |
| PCS0 | 25 | 53 | O | Peripheral Chip Select signals 0-4 are active LOW when a reference is made to the defined peripheral area (64K byte I/O space). These lines are not floated during bus HOLD. The address ranges activating PCS0-4 are software programmable. |
| PCS1-4 | 27, 28 29, 30 | 51, 50 49, 48 | O | |
| PCS5/A1 | 31 | 47 | O | |
| PCS6/A2 | 32 | 46 | O | Peripheral Chip Select 6 or Latched A2 may be programmed to provide a seventh peripheral chip select, or to provide an internally latched A2 signal. The address range activating PCS6 is software programmable. When programmed to provide latched A2, rather than PCS6, this pin will retain the previously latched value of A2 during a bus HOLD. A2 is active HIGH. |
| DT/R | 40 | 38 | O | Data Transmit/Receive controls the direction of data flow through the external M8286/M8287 data bus transceiver. When LOW, data is transferred to the M80186. When HIGH the M80186 places write data on the data bus. |
| DEN | 39 | 39 | O | Data Enable is provided as an M8286/M8287 data bus transceiver output enable. DEN is active LOW during each memory and I/O access. DEN is HIGH whenever DT/R changes state. |

T-49-17-15

FUNCTIONAL DESCRIPTION

Introduction

The following Functional Description describes the base architecture of the M80186. This architecture is common to the M8086, M8088 and M80286 microprocessor families as well. The M80186 is a very high integration 16-bit microprocessor. It combines 15-20 of the most common microprocessor system components onto one chip while providing twice the performance of the standard M8086. The M80186 is object code compatible with the M8086, M8088 microprocessors and adds 10 new instruction types to the existing M8086, M8088 instruction set.

M80186 BASE ARCHITECTURE

The M8086, M8088, M80186 and M80286 family all contain the same basic set of registers, instructions, and addressing modes. The M80186 processor is upward compatible with the M8086, M8088, and M80286 CPUs.

Register Set

The M80186 base architecture has fourteen registers as shown in Figures 3a and 3b. These registers are grouped into the following categories.

General Registers

Eight 16-bit general purpose registers may be used to contain arithmetic and logical operands. Four of these (AX, BX, CX, and DX) can be used as 16-bit registers or split into pairs of separate 8-bit registers.

Segment Registers

Four 16-bit special purpose registers select, at any given time, the segments of memory that are immediately addressable for code, stack, and data. (For usage, refer to Memory Organization.)

Base and Index Registers

Four of the general purpose registers may also be used to determine offset addresses of operands in memory. These registers may contain base addresses or indexes to particular locations within a segment. The addressing mode selects the specific registers for operand and address calculations.

Status and Control Registers

Two 16-bit special purpose registers record or alter certain aspects of the M80186 processor state. These are the Instruction Pointer Register, which contains the offset address of the next sequential instruction to be executed, and the Status Word Register, which contains status and control flag bits (see Figures 3a and 3b).

Status Word Description

The Status Word records specific characteristics of the result of logical and arithmetic instructions (bits 0, 2, 4, 6, 7, and 11) and controls the operation of the M80186 within a given operating mode (bits 8, 9, and 10). The Status Word Register is 16-bits wide. The function of the Status Word bits is shown in Table 2.

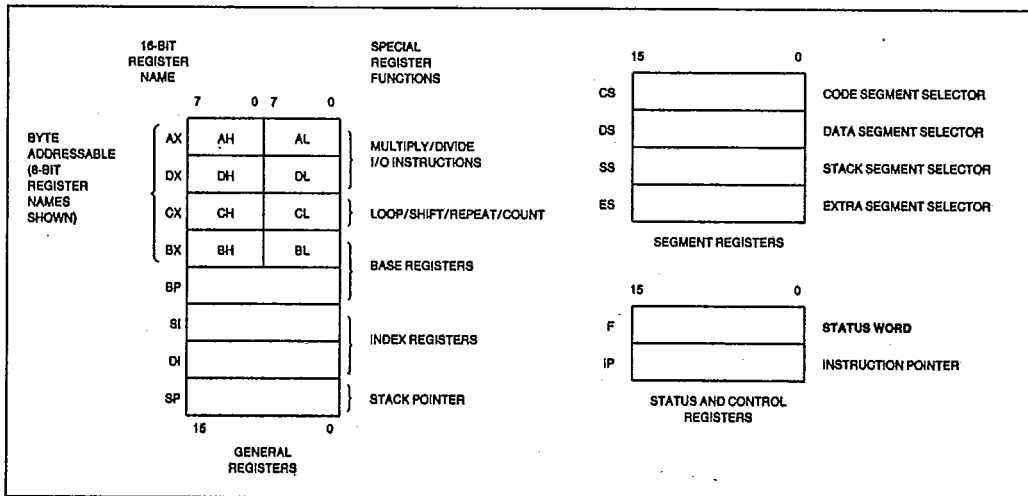

Figure 3a. M80186 General Purpose Register Set

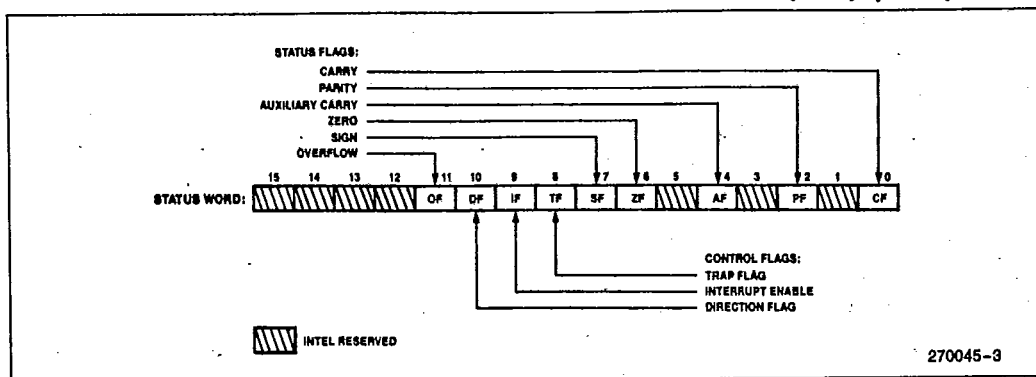

Figure 3b. Status Word Format

Table 2. Status Word Bit Functions

| Bit Position | Name | Function |
|--------------|------|--|
| 0 | CF | Carry Flag—Set on high-order bit carry or borrow; cleared otherwise |
| 2 | PF | Parity Flag—Set if low-order 8 bits of result contain an even number of 1-bits; cleared otherwise |
| 4 | AF | Set on carry from or borrow to the low order four bits of AL; cleared otherwise |
| 6 | ZF | Zero Flag—Set if result is zero; cleared otherwise |
| 7 | SF | Sign Flag—Set equal to high-order bit of result (0 if positive, 1 if negative) |
| 8 | TF | Single Step Flag—Once set, a single step interrupt occurs after the next instruction executes. TF is cleared by the single step interrupt. |
| 9 | IF | Interrupt-enable Flag—When set, maskable interrupts will cause the CPU to transfer control to an interrupt vector specified location. |
| 10 | DF | Direction Flag—Causes string instructions to auto decrement the appropriate index register when set. Clearing DF causes auto increment. |
| 11 | OF | Overflow Flag—Set if the signed result cannot be expressed within the number of bits in the destination operand; cleared otherwise |

Instruction Set

The instruction set is divided into seven categories: data transfer, arithmetic, shift/rotate/logical, string manipulation, control transfer, high-level instructions, and processor control. These categories are summarized in Figure 4.

An M80186 instruction can reference anywhere from zero to several operands. An operand can reside in a register, in the instruction itself, or in memory. Specific operand addressing modes are discussed later in this data sheet.

Memory Organization

Memory is organized in sets of segments. Each segment is a linear contiguous sequence of up to 64K (2¹⁶) 8-bit bytes. Memory is addressed using a two-component address (a pointer) that consists of a 16-bit base segment and a 16-bit offset. The 16-bit base values are contained in one of four internal segment register (code, data, stack, extra). The physical address is calculated by shifting the base value LEFT by four bits and adding the 16-bit offset value to yield a 20-bit physical address (see Figure 5). This allows for a 1 MByte physical address size.

All instructions that address operands in memory must specify the base segment and the 16-bit offset value. For speed and compact instruction encoding, the segment register used for physical address generation is implied by the addressing mode used (see Table 3). These rules follow the way programs are written (see Figure 6) as independent modules that require areas for code and data, a stack, and access to external data areas.

Special segment override instruction prefixes allow the implicit segment register selection rules to be overridden for special cases. The stack, data, and extra segments may coincide for simple programs.



T-49-17-15

| GENERAL PURPOSE | |
|--------------------------|--|
| MOV | Move byte or word |
| PUSH | Push word onto stack |
| POP | Pop word off stack |
| PUSHA | Push all registers on stack |
| POPA | Pop all registers from stack |
| XCHG | Exchange byte or word |
| XLAT | Translate byte |
| INPUT/OUTPUT | |
| IN | Input byte or word |
| OUT | Output byte or word |
| ADDRESS OBJECT | |
| LEA | Load effective address |
| LDS | Load pointer using DS |
| LES | Load pointer using ES |
| FLAG TRANSFER | |
| LAHF | Load AH register from flags |
| SAHF | Store AH register in flags |
| PUSHF | Push flags onto stack |
| POPF | Pop flags off stack |
| ADDITION | |
| ADD | Add byte or word |
| ADC | Add byte or word with carry |
| INC | Increment byte or word by 1 |
| AAA | ASCII adjust for addition |
| DAA | Decimal adjust for addition |
| SUBTRACTION | |
| SUB | Subtract byte or word |
| SBB | Subtract byte or word with borrow |
| DEC | Decrement byte or word by 1 |
| NEG | Negate byte or word |
| CMP | Compare byte or word |
| AAS | ASCII adjust for subtraction |
| DAS | Decimal adjust for subtraction |
| MULTIPLICATION | |
| MUL | Multiply byte or word unsigned |
| IMUL | Integer multiply byte or word |
| AAM | ASCII adjust for multiply |
| DIVISION | |
| DIV | Divide byte or word unsigned |
| IDIV | Integer divide byte or word |
| AAD | ASCII adjust for division |
| CBW | Convert byte to word |
| CWD | Convert word to doubleword |
| MOVS | Move byte or word string |
| INS | Input bytes or word string |
| OUTS | Output bytes or word string |
| CMPS | Compare byte or word string |
| SCAS | Scan byte or word string |
| LODS | Load byte or word string |
| STOS | Store byte or word string |
| REP | Repeat |
| REPE/REPZ | Repeat while equal/zero |
| REPNE/REPNZ | Repeat while not equal/not zero |
| LOGICALS | |
| NOT | "Not" byte or word |
| AND | "And" byte or word |
| OR | "Inclusive or" byte or word |
| XOR | "Exclusive or" byte or word |
| TEST | "Test" byte or word |
| SHIFTS | |
| SHL/SAL | Shift logical/arithmetic left byte or word |
| SHR | Shift logical right byte or word |
| SAR | Shift arithmetic right byte or word |
| ROTATES | |
| ROL | Rotate left byte or word |
| ROR | Rotate right byte or word |
| RCL | Rotate through carry left byte or word |
| RCR | Rotate through carry right byte or word |
| FLAG OPERATIONS | |
| STC | Set carry flag |
| CLC | Clear carry flag |
| CMC | Complement carry flag |
| STD | Set direction flag |
| CLD | Clear direction flag |
| STI | Set interrupt enable flag |
| CLI | Clear interrupt enable flag |
| EXTERNAL SYNCHRONIZATION | |
| HLT | Halt until interrupt or reset |
| WAIT | Wait for TEST pin active |
| ESC | Escape to extension processor |
| LOCK | Lock bus during next instruction |
| NO OPERATION | |
| NOP | No operation |
| HIGH LEVEL INSTRUCTIONS | |
| ENTER | Format stack for procedure entry |
| LEAVE | Restore stack for procedure exit |
| BOUND | Detects values outside prescribed range |

Figure 4. M80186 Instruction Set



T-49-17-15

| CONDITIONAL TRANSFERS | | | |
|-----------------------|------------------------------------|-------------------------|----------------------------|
| JA/JNBE | Jump if above/not below nor equal | JO | Jump if overflow |
| JAE/JNB | Jump if above or equal/not below | JP/JPE | Jump if parity/parity even |
| JB/JNAE | Jump if below/not above nor equal | JS | Jump if sign |
| JBE/JNA | Jump if below or equal/not above | UNCONDITIONAL TRANSFERS | |
| JC | Jump if carry | CALL | Call procedure |
| JE/JZ | Jump if equal/zero | RET | Return from procedure |
| JG/JNLE | Jump if greater/not less nor equal | JMP | Jump |
| JGE/JNL | Jump if greater or equal/not less | ITERATION CONTROLS | |
| JL/JNGE | Jump if less/not greater nor equal | LOOP | Loop |
| JLE/JNG | Jump if less or equal/not greater | LOOPE/LOOPZ | Loop if equal/zero |
| JNC | Jump if not carry | LOOPNE/LOOPNZ | Loop if not equal/not zero |
| JNE/JNZ | Jump if not equal/not zero | JCXZ | Jump if register CX = 0 |
| JNO | Jump if not overflow | INTERRUPTS | |
| JNP/JPO | Jump if not parity/parity odd | INT | Interrupt |
| JNS | Jump if not sign | INTO | Interrupt if overflow |
| | | IRET | Interrupt return |

Figure 4. M80186 Instruction Set (Continued)

To access operands that do not reside in one of the four immediately available segments, a full 32-bit pointer can be used to reload both the base (segment) and offset values.

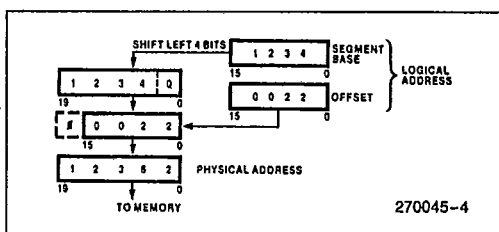

Figure 5. Two Component Address

Table 3. Segment Register Selection Rules

| Memory Reference Needed | Segment Register Used | Implicit Segment Selection Rule |
|-------------------------|-----------------------|--|
| Instructions | Code (CS) | Instruction prefetch and immediate data. |
| Stack | Stack (SS) | All stack pushes and pops; any memory references which use BP Register as a base register. |
| External Data (Global) | Extra (ES) | All string instruction references which use the DI register as an index. |
| Local Data | Data (DS) | All other data references. |

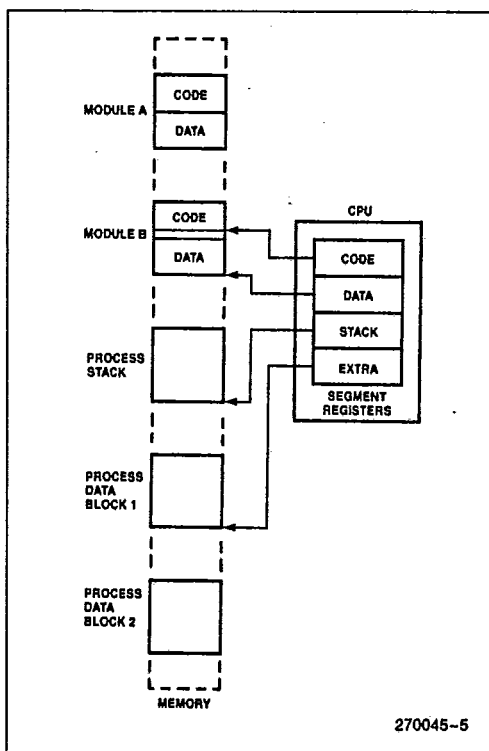

Figure 6. Segmented Memory Helps Structure Software



T-49-17-15

Addressing Modes

The M80186 provides eight categories of addressing modes to specify operands. Two addressing modes are provided for instructions that operate on register or immediate operands:

- **Register Operand Mode:** The operand is located in one of the 8- or 16-bit general registers.
- **Immediate Operand Mode:** The operand is included in the instruction.

Six modes are provided to specify the location of an operand in a memory segment. A memory operand address consists of two 16-bit components: a segment base and an offset. The segment base is supplied by a 16-bit segment register either implicitly chosen by the addressing mode or explicitly chosen by a segment override prefix. The offset, also called the effective address, is calculated by summing any combination of the following three address elements:

- the *displacement* (an 8- or 16-bit immediate value contained in the instruction);
- the *base* (contents of either the BX or BP base registers); and
- the *index* (contents of either the SI or DI index registers).

Any carry out from the 16-bit addition is ignored. Eight-bit displacements are sign extended to 16-bit values.

Combinations of these three address elements define the six memory addressing modes, described below.

- **Direct Mode:** The operand's offset is contained in the instruction as an 8- or 16-bit displacement element.
- **Register Indirect Mode:** The operand's offset is in one of the registers SI, DI, BX, or BP.
- **Based Mode:** The operand's offset is the sum of an 8- or 16-bit displacement and the contents of a base register (BX or BP).
- **Indexed Mode:** The operand's offset is the sum of an 8- or 16-bit displacement and the contents of an index register (SI or DI).
- **Based Indexed Mode:** The operand's offset is the sum of the contents of a base register and an index register.
- **Based indexed Mode with Displacement:** The operand's offset is the sum of a base register's contents, an index register's contents, and an 8- or 16-bit displacement.

Data Types

The M80186 directly supports the following data types:

- **Integer:** A signed binary numeric value contained in an 8-bit byte or a 16-bit word. All operations assume a 2's complement representation. Signed 32- and 64-bit integers are supported using the M80186 Numeric Data Processor.
- **Ordinal:** An unsigned binary numeric value contained in an 8-bit byte or a 16-bit word.
- **Pointer:** A 16- or 32-bit quantity, composed of a 16-bit offset component or a 16-bit segment base component in addition to a 16-bit offset component.
- **String:** A contiguous sequence of bytes or words. A string may contain from 1 to 64K bytes.
- **ASCII:** A byte representation of alphanumeric and control characters using the ASCII standard of character representation.
- **BCD:** A byte (unpacked) representation of the decimal digits 0-9.
- **Packed BCD:** A byte (packed) representation of two decimal digits (0-9). One digit is stored in each nibble (4-bits) of the byte.
- **Floating Point:** A signed 32-, 64-, or 80-bit real number representation. (Floating point operands are supported using the M80186 Numeric Data Processor configuration.)

In general, individual data elements must fit within defined segment limits. Figure 7 graphically represents the data types supported by the M80186.

I/O Space

The I/O space consists of 64K 8-bit or 32K 16-bit ports. Separate instructions address the I/O space with either an 8-bit port address, specified in the instruction, or a 16-bit port address in the DX register. 8-bit port addresses are zero extended such that A₁₅-A₈ are LOW. I/O port addresses 00F8(H) through 00FF(H) are reserved.

Interrupts

An interrupt transfers execution to a new program location. The old program address (CS:IP) and machine state (Status Word) are saved on the stack to allow resumption of the interrupted program. Interrupts fall into three classes: hardware initiated, INT instructions, and instruction exceptions. Hardware initiated interrupts occur in response to an external input and are classified as non-maskable or maskable.

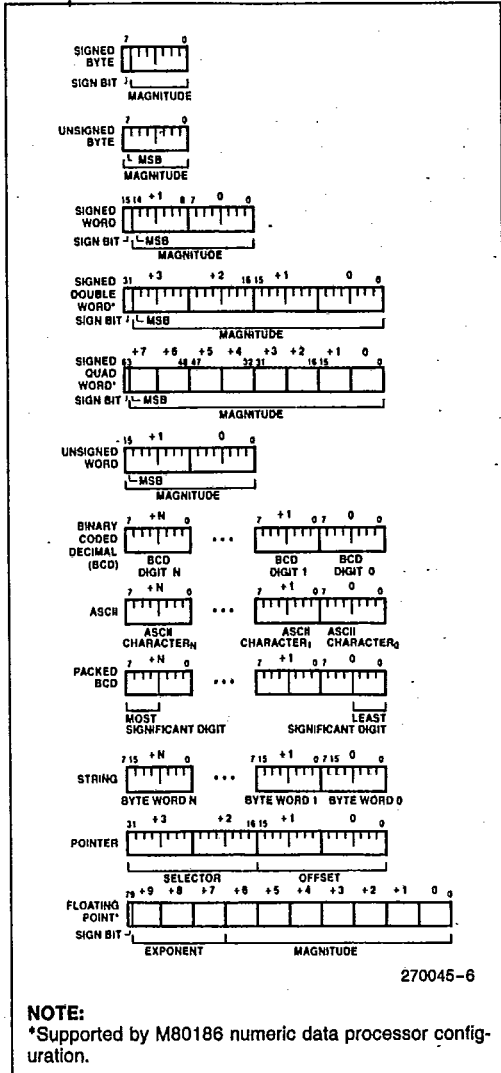

Figure 7. M80186 Supported Data Types

Programs may cause an interrupt with an INT instruction. Instruction exceptions occur when an unusual condition, which prevents further instruction processing, is detected while attempting to execute an instruction. If the exception was caused by executing an ESC instruction with the ESC trap bit set in the relocation register, the return instruction will point to the ESC instruction, or to the segment override prefix immediately preceding the ESC instruction if the prefix was present. In all other cases, the return address from an exception will point at the instruction immediately following the instruction causing the exception.

A table containing up to 256 pointers defines the proper interrupt service routine for each interrupt. Interrupts 0-31, some of which are used for instruction exceptions, are reserved. Table 4 shows the M80186 predefined types and default priority levels. For each interrupt, an 8-bit vector must be supplied to the M80186 which identifies the appropriate table entry. Exceptions supply the interrupt vector internally. In addition, internal peripherals and noncascaded external interrupts will generate their own vectors through the internal interrupt controller. INT instructions contain or imply the vector and allow access to all 256 interrupts. Maskable hardware initiated interrupts supply the 8-bit vector to the CPU during an interrupt acknowledge bus sequence. Non-maskable hardware interrupts use a predefined internally supplied vector.

Interrupt Sources

The M80186 can service interrupts generated by software or hardware. The software interrupts are generated by specific instructions (INT, ESC, unused OP, etc.) or the results of conditions specified by instructions (array bounds check, INTO, DIV, IDIV, etc.). All interrupt sources are serviced by an indirect call through an element of a vector table. This vector table is indexed by using the interrupt vector type (Table 4), multiplied by four. All hardware-generated interrupts are sampled at the end of each instruction. Thus, the software interrupts will begin service first. Once the service routine is entered and interrupts are enabled, any hardware source of sufficient priority can interrupt the service routine in progress.

The software generated M80186 interrupts are described below.

DIVIDE ERROR EXCEPTION (TYPE 0)

Generated when a DIV or IDIV instruction quotient cannot be expressed in the number of bits in the destination.

SINGLE-STEP INTERRUPT (TYPE 1)

Generated after most instructions if the TF flag is set. Interrupts will not be generated after prefix instructions (e.g., REP), instructions which modify segment registers (e.g., POP DS), or the WAIT instruction.

NON-MASKABLE INTERRUPT—NMI (TYPE 2)

An external interrupt source which cannot be masked.



T-49-17-15

Table 4. M80186 Interrupt Vectors

| Interrupt Name | Vector Type | Default Priority | Related Instructions |
|----------------------------------|-------------|------------------|----------------------|
| Divide Error Exception | 0 | *1 | DIV, IDIV |
| Single Step Interrupt | 1 | 12**2 | All |
| NMI | 2 | 1 | All |
| Breakpoint Interrupt | 3 | *1 | INT |
| INT0 Detected Overflow Exception | 4 | *1 | INT0 |
| Array Bounds Exception | 5 | *1 | BOUND |
| Unused-Opcode Exception | 6 | *1 | Undefined Opcodes |
| ESC Opcode Exception | 7 | *1*** | ESC Opcodes |
| Timer 0 Interrupt | 8 | 2A**** | |
| Timer 1 Interrupt | 18 | 2B**** | |
| Timer 2 Interrupt | 19 | 2C**** | |
| Reserved | 9 | 3 | |
| DMA 0 Interrupt | 10 | 4 | |
| DMA 1 Interrupt | 11 | 5 | |
| INT0 Interrupt | 12 | 6 | |
| INT1 Interrupt | 13 | 7 | |
| INT2 Interrupt | 14 | 8 | |
| INT3 Interrupt | 15 | 9 | |

NOTES:

*1. These are generated as the result of an instruction execution.

**2. This is handled as in the M8086.

***3. All three timers constitute one source of request to the interrupt controller. The Timer interrupts all have the same default priority level with respect to all other interrupt sources. However, they have a defined priority ordering amongst themselves. (Priority 2A is higher priority than 2B.) Each Timer interrupt has a separate vector type number.

4. Default priorities for the interrupt sources are used only if the user does not program each source into a unique priority level.

***5. An escape opcode will cause a trap only if the proper bit is set in the peripheral control block relocation register.

BREAKPOINT INTERRUPT (TYPE 3)

A one-byte version of the INT instruction. It uses 12 as an index into the service routine address table (because it is a type 3 interrupt).

INT0 DETECTED OVERFLOW EXCEPTION (TYPE 4)

Generated during an INT0 instruction if the OF bit is set.

ARRAY BOUNDS EXCEPTION (TYPE 5)

Generated during a BOUND instruction if the array index is outside the array bounds. The array bounds are located in memory at a location indicated by one of the instruction operands. The other operand indicates the value of the index to be checked.

UNUSED OPCODE EXCEPTION (TYPE 6)

Generated if execution is attempted on undefined opcodes.

ESCAPE OPCODE EXCEPTION (TYPE 7)

Generated if execution is attempted of ESC opcodes (D8H-DFH). This exception will only be generated if a bit in the relocation register is set. The return address of this exception will point to the ESC instruction causing the exception. If a segment override prefix preceded the ESC instruction, the return address will point to the segment override prefix.

Hardware-generated interrupts are divided into two groups: maskable interrupts and non-maskable interrupts. The M80186 provides maskable hardware interrupt request pins INT0-INT3. In addition, maskable interrupts may be generated by the M80186 integrated DMA controller and the integrated timer unit. The vector types for these interrupts is shown in Table 4. Software enables these inputs by setting the interrupt flag bit (IF) in the Status Word. The interrupt controller is discussed in the peripheral section of this data sheet.

Further maskable interrupts are disabled while servicing an interrupt because the IF bit is reset as part of the response to an interrupt or exception. The saved Status Word will reflect the enable status of the processor prior to the interrupt. The interrupt flag will remain zero unless specifically set. The interrupt return instruction restores the Status Word, thereby restoring the original status of IF bit. If the interrupt return re-enables interrupts, and another interrupt is pending, the M80186 will immediately service the highest-priority interrupt pending, i.e., no instructions of the main line program will be executed.

Non-Maskable Interrupt Request (NMI)

A non-maskable interrupt (NMI) is also provided. This interrupt is serviced regardless of the state of the IF bit. A typical use of NMI would be to activate a power failure routine. The activation of this input causes an interrupt with an internally supplied vector value of 2. No external interrupt acknowledge sequence is performed. The IF bit is cleared at the beginning of an NMI interrupt to prevent maskable interrupts from being serviced.



M80186

PRELIMINARY

T-49-17-15

Single-Step Interrupt

The M80186 has an internal interrupt that allows programs to execute one instruction at a time. It is called the single-step interrupt and is controlled by the single-step flag bit (TF) in the Status Word. Once this bit is set, an internal single-step interrupt will occur after the next instruction has been executed. The interrupt clears the TF bit and uses an internally supplied vector of 1. The IRET instruction is used to set the TF bit and transfer control to the next instruction to be single-stepped.

Initialization and Processor Reset

Processor initialization or startup is accomplished by driving the $\overline{\text{RES}}$ input pin LOW. $\overline{\text{RES}}$ forces the M80186 to terminate all execution and local bus activity. No instruction or bus activity will occur as long as $\overline{\text{RES}}$ is active. After $\overline{\text{RES}}$ becomes inactive and an internal processing interval elapses, the M80186 begins execution with the instruction at physical location FFFF0(H). $\overline{\text{RES}}$ also sets some registers to predefined values as shown in Table 5.

Table 5. M80186 Initial Register State after RESET

| | |
|---------------------|---------|
| Status Word | F002(H) |
| Instruction Pointer | 0000(H) |
| Code Segment | FFFF(H) |
| Data Segment | 0000(H) |
| Extra Segment | 0000(H) |
| Stack Segment | 0000(H) |
| Relocation Register | 20FF(H) |
| UMCS | FFFB(H) |

M80186 CLOCK GENERATOR

The M80186 provides an on-chip clock generator for both internal and external clock generation. The clock generator features a crystal oscillator, a divide-by-two counter, synchronous and asynchronous ready inputs, and reset circuitry.

Oscillator

The oscillator circuit of the M80186 is designed to be used with a parallel resonant fundamental mode crystal. This is used as the time base for the M80186. The crystal frequency selected will be double the CPU clock frequency. Use of an LC or RC circuit is not recommended with this oscillator. If an external oscillator is used, it can be connected directly to input pin X1 in lieu of a crystal. The output

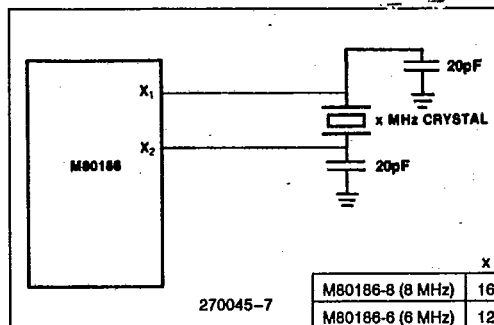

Figure 8. Recommended M80186 Crystal Configuration

of the oscillator is not directly available outside the M80186. The recommended crystal configuration is shown in Figure 8.

Clock Generator

The M80186 clock generator provides the 50% duty cycle processor clock for the M80186. It does this by dividing the oscillator output by 2 forming the symmetrical clock. If an external oscillator is used, the state of the clock generator will change on the falling edge of the oscillator signal. The CLKOUT pin provides the processor clock signal for use outside the M80186. This may be used to drive other system components. All timings are referenced to the output clock.

READY Synchronization

The M80186 provides both synchronous and asynchronous ready inputs. Asynchronous ready synchronization is accomplished by circuitry which samples ARDY in the middle of T_2 , T_3 and again in the middle of each T_W until ARDY is sampled HIGH. One-half CLKOUT cycle of resolution time is used. Full synchronization is performed only on the rising edge of ARDY, i.e., the falling edge of ARDY must be synchronized to the CLKOUT signal if it will occur during T_2 , T_3 , or T_W . High-to-LOW transitions of ARDY must be performed synchronously to the CPU clock.

A second ready input (SRDY) is provided to interface with externally synchronized ready signals. This input is sampled at the end of T_2 , T_3 and again at the end of each T_W until it is sampled HIGH. By using this input rather than the asynchronous ready input, the half-clock cycle resolution time penalty is eliminated.



T-49-17-15

This input must satisfy set-up and hold times to guarantee proper operation of the circuit.

In addition, the M80186, as part of the integrated chip-select logic, has the capability to program WAIT states for memory and peripheral blocks. This is discussed in the Chip Select/Ready Logic description.

RESET Logic

The M80186 provides both a \overline{RES} input pin and a synchronized RESET pin for use with other system components. The \overline{RES} input pin on the M80186 is provided with hysteresis in order to facilitate power-on Reset generation via an RC network. RESET is guaranteed to remain active for at least five clocks given a \overline{RES} input of at least six clocks. RESET may be delayed up to two and one-half clocks behind \overline{RES} .

Multiple M80186 processors may be synchronized through the \overline{RES} input pin, since this input resets both the processor and divide-by-two internal counter in the clock generator. In order to insure that the divide-by-two counters all begin counting at the same time, the active going edge of \overline{RES} must satisfy a 25 ns setup time before the falling edge of the M80186 clock input. In addition, in order to insure that all CPUs begin executing in the same clock cycle, the reset must satisfy a 25 ns setup time before the rising edge of the CLKOUT signal of all the processors.

LOCAL BUS CONTROLLER

The M80186 provides a local bus controller to generate the local bus control signals. In addition, it employs a HOLD/HLDA protocol for relinquishing the local bus to other bus masters. It also provides control lines that can be used to enable external buffers and to direct the flow of data on and off the local bus.

Memory/Peripheral Control

The M80186 provides ALE, \overline{RD} , and \overline{WR} bus control signals. The \overline{RD} and \overline{WR} signals are used to strobe data from memory to the M80186 or to strobe data from the M80186 to memory. The ALE line provides a strobe to address latches for the multiplexed address/data bus. The M80186 local bus controller does not provide a memory/I/O signal. If this is required, the user will have to use the S2 signal (which will require external latching), make the memory and I/O spaces nonoverlapping, or use only the integrated chip-select circuitry.

Transceiver Control

The M80186 generates two control signals to be connected to M8286/M8287 transceiver chips. This capability allows the addition of transceivers for extra buffering without adding external logic. These control lines, DT/R and \overline{DEN} , are generated to control the flow of data through the transceivers. The operation of these signals is shown in Table 6.

Table 6. Transceiver Control Signals Description

| Pin Name | Function |
|--------------------------------|--|
| \overline{DEN} (Data Enable) | Enables the output drivers of the transceivers. It is active LOW during memory, I/O, or INTA cycles. |
| DT/R (Data Transmit/Receive) | Determines the direction of travel through the transceivers. A HIGH level directs data away from the processor during write operations, while a LOW level directs data toward the processor during a read operation. |

Local Bus Arbitration

The M80186 uses a HOLD/HLDA system of local bus exchange. This provides an asynchronous bus exchange mechanism. This means multiple masters utilizing the same bus can operate at separate clock frequencies. The M80186 provides a single HOLD/HLDA pair through which all other bus masters may gain control of the local bus. This requires external circuitry to arbitrate which external device will gain control of the bus from the M80186 when there is more than one alternate local bus master. When the M80186 relinquishes control of the local bus, it floats \overline{DEN} , \overline{RD} , \overline{WR} , S_0 - S_2 , \overline{LOCK} , AD0-AD15, A16-A19, \overline{BHE} , and DT/R to allow another master to drive these lines directly.

The M80186 HOLD latency time, i.e., the time between HOLD request and HOLD acknowledge, is a function of the activity occurring in the processor when the HOLD request is received. A HOLD request is the highest-priority activity request which the processor may receive: higher than instruction fetching or internal DMA cycles. However, if a DMA cycle is in progress, the M80186 will complete the transfer before relinquishing the bus. This implies that if a HOLD request is received just as a DMA transfer begins, the HOLD latency time can be as great as 4 bus cycles. This will occur if a DMA word transfer operation is taking place from an odd ad-



dress to an odd address. This is a total of 16 clocks or more, if WAIT states are required. In addition, if locked transfers are performed, the HOLD latency time will be increased by the length of the locked transfer.

Local Bus Controller and Reset

Upon receipt of a RESET pulse from the \overline{RES} input, the local bus controller will perform the following action:

- Drive \overline{DEN} , \overline{RD} , and \overline{WR} HIGH for one clock cycle, then float.

NOTE:

\overline{RD} is also provided with an internal pull-up device to prevent the processor from inadvertently entering Queue Status mode during reset.

- Drive $\overline{S0}$ – $\overline{S2}$ to the passive state (all HIGH) and then float.
- Drive \overline{LOCK} HIGH and then float.
- TRISTATE AD0–15, A16–19, \overline{BHE} , DT/ \overline{R} .
- Drive ALE LOW (ALE is never floated).
- Drive HLDA LOW.

INTERNAL PERIPHERAL INTERFACE

All the M80186 integrated peripherals are controlled via 16-bit registers contained within an internal 256-byte control block. This control block may be mapped into either memory or I/O space. Internal logic will recognize the address and respond to the bus cycle. During bus cycles to internal registers, the bus controller will signal the operation externally (i.e., the \overline{RD} , \overline{WR} , status, address, data, etc., lines will be driven as in a normal bus cycle), but D_{15–0}, SRDY, and ARDY will be ignored. The base address of the control block must be on an even 256-byte boundary (i.e., the lower 8 bits of the base address are all zeros). All of the defined registers within this control block may be read or written by the M80186 CPU at any time. The location of any register contained within the 256-byte control block is determined by the current base address of the control block.

The control block base address is programmed via a 16-bit relocation register contained within the control block at offset FEH from the base address of the control block (see Figure 9). It provides the upper 12 bits of the base address of the control block. The control block is effectively an internal chip select range and must abide by all the rules concerning chip selects (the chip select circuitry is discussed later in this data sheet). Any access to the 256 bytes of the control block activates an internal chip select.

Other chip selects may overlap the control block only if they are programmed to zero wait states and ignore external ready. In addition, bit 12 of this register determines whether the control block will be mapped into I/O or memory space. If this bit is 1, the control block will be located in memory space, whereas if the bit is 0, the control block will be located in I/O space. If the control register block is mapped into I/O space, the upper 4 bits of the base address must be programmed as 0 (since I/O addresses are only 16 bits wide).

In addition to providing relocation information for the control block, the relocation register contains bits which place the interrupt controller into iRMX mode, and cause the CPU to interrupt upon encountering ESC instructions. At RESET, the relocation register is set to 20FFH. This causes the control block to start at FF00H in I/O space. An offset map of the 256-byte control register block is shown in Figure 10.

The integrated M80186 peripherals operate semi-autonomously from the CPU. Access to them for the most part is via software read/write of the control block. Most of these registers can be both read and written. A few dedicated lines, such as interrupts and DMA request provide real-time communication between the CPU and peripherals as in a more conventional system utilizing discrete peripheral blocks. The overall interaction and function of the peripheral blocks has not substantially changed.

CHIP-SELECT/READY GENERATION LOGIC

The M80186 contains logic which provides programmable chip-select generation for both memories and peripherals. In addition, it can be programmed to provide READY (or WAIT state) generation. It can also provide latched address bits A1 and A2. The chip-select lines are active for all memory and I/O cycles in their programmed areas, whether they be generated by the CPU or by the integrated DMA unit.

Memory Chip Selects

The M80186 provides 6 memory chip select outputs for 3 address areas; upper memory, lower memory, and midrange memory. One each is provided for upper memory and lower memory, while four are provided for midrange memory.

The range for each chip select is user-programmable and can be set to 2K, 4K, 8K, 16K, 32K, 64K, 128K (plus 1K and 256K for upper and lower chip selects). In addition, the beginning or base address



T-49-17-15

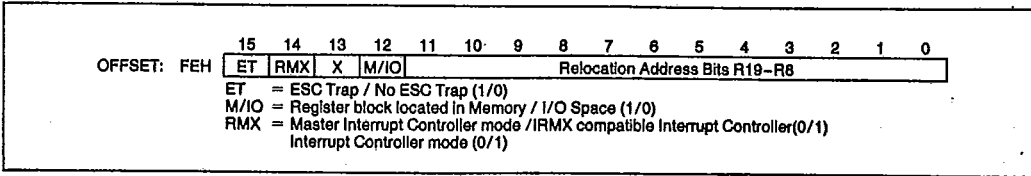

Figure 9. Relocation Register

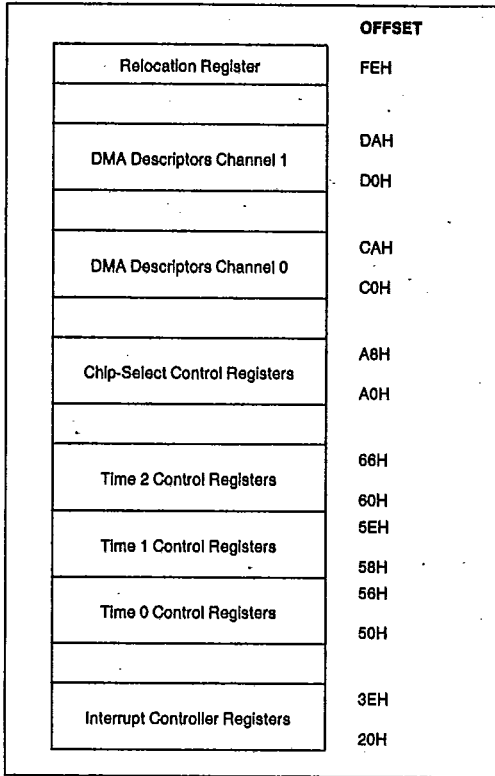

Figure 10. Internal Register Map

of the midrange memory chip select may also be selected. Only one chip select may be programmed to be active for any memory location at a time. All chip select sizes are in bytes, whereas M80186 memory is arranged in words. This means that if, for example, 16 64K x 1 memories are used, the memory block size will be 128K, not 64K.

Upper Memory \overline{CS}

The M80186 provides a chip select, called \overline{UCS} , for the top of memory. The top of memory is usually used as the system memory because after reset the M80186 begins executing at memory location FFFF0H.

The upper limit of memory defined by this chip select is always FFFFH, while the lower limit is programmable. By programming the lower limit, the size of the select block is also defined. Table 7 shows the relationship between the base address selected and the size of the memory block obtained.

Table 7. UMCS Programming Values

| Starting Address (Base Address) | Memory Block Size | UMCS Value (Assuming R0 = R1 = R2 = 0) |
|---------------------------------|-------------------|--|
| FFC00 | 1K | FFF8H |
| FF800 | 2K | FFB8H |
| FF000 | 4K | FF38H |
| FE000 | 8K | FE38H |
| FC000 | 16K | FC38H |
| F8000 | 32K | F838H |
| F0000 | 64K | F038H |
| E0000 | 128K | E038H |
| C0000 | 256K | C038H |

The lower limit of this memory block is defined in the UMCS register (see Figure 11). This register is at offset A0H in the internal control block. The legal values for bits 6-13 and the resulting starting address and memory block sizes are given in Table 7. Any combination of bits 6-13 not shown in Table 7 will result in undefined operation. After reset, the UMCS register is programmed for a 1K area. It must be reprogrammed if a larger upper memory area is desired.

Any internally generated 20-bit address whose upper 16 bits are greater than or equal to UMCS (with bits 0-5 "0") will cause UCS to be activated. UMCS bits R2-R0 are used to specify READY mode for the area of memory defined by this chip-select register, as explained below.

Lower Memory \overline{CS}

The M80186 provides a chip select for low memory called \overline{LCS} . The bottom of memory contains the interrupt vector table, starting at location 00000H.



T-49-17-15

The lower limit of memory defined by this chip select is always 0H, while the upper limit is programmable. By programming the upper limit, the size of the memory block is also defined. Table 8 shows the relationship between the upper address selected and the size of the memory block obtained.

Table 8. LMCS Programming Values

| Upper Address | Memory Block Size | LMCS Value (Assuming R0=R1=R2=0) |
|---------------|-------------------|----------------------------------|
| 003FFH | 1K | 0038H |
| 007FFH | 2K | 0078H |
| 00FFFH | 4K | 00F8H |
| 01FFFH | 8K | 01F8H |
| 03FFFH | 16K | 03F8H |
| 07FFFH | 32K | 07F8H |
| 0FFFFH | 64K | 0FF8H |
| 1FFFFH | 128K | 1FF8H |
| 3FFFFH | 256K | 3FF8H |

The upper limit of this memory block is defined in the LMCS register (see Figure 12). This register is at offset A2H in the internal control block. The legal values for bits 6-15 and the resulting upper address and memory block sizes are given in Table 8. Any combination of bits 6-15 not shown in Table 8 will result in undefined operation. After reset, the LMCS register value is undefined. However, the LCS chip-select line will not become active until the LMCS register is accessed.

Any internally generated 20-bit address whose upper 16 bits are less than or equal to LMCS (with bits 0-5 "1") will cause LCS to be active. LMCS register bits R2-R0 are used to specify the READY mode for the area of memory defined by this chip-select register.

Mid-Range Memory CS

The M80186 provides four MCS lines which are active within a user-locatable memory block. This block can be located anywhere within the M80186 1M byte memory address space exclusive of the areas defined by UCS and LCS. Both the base ad-

dress and size of this memory block are programmable.

The size of the memory block defined by the mid-range select lines, as shown in Table 9, is determined by bits 8-14 of the MPCS register (see Figure 13). This register is at location A8H in the internal control block. One and only one of bits 8-14 must be set at a time. Unpredictable operation of the MCS lines will otherwise occur. Each of the four chip-select lines is active for one of the four equal contiguous divisions of the mid-range block. Thus, if the total block size is 32K, each chip select is active for 8K of memory with MCS0 being active for the first range and MCS3 being active for the last range.

The EX and MS in MPCS relate to peripheral functionality as described in a later section.

Table 9. MPCS Programming Values

| Total Block Size | Individual Select Size | MPCS Bits 14-8 |
|------------------|------------------------|----------------|
| 8K | 2K | 0000001B |
| 16K | 4K | 0000010B |
| 32K | 8K | 0000100B |
| 64K | 16K | 0001000B |
| 128K | 32K | 0010000B |
| 256K | 64K | 0100000B |
| 512K | 128K | 1000000B |

The base address of the mid-range memory block is defined by bits 15-9 of the MMCS register (see Figure 14). This register is at offset A6H in the internal control block. These bits correspond to bits A19-A13 of the 20-bit memory address. Bits A12-A0 of the base address are always 0. The base address may be set at any integer multiple of the size of the total memory block selected. For example, if the mid-range block size is 32K (or the size of the block for which each MCS line is active is 8K), the block could be located at 10000H or 18000H, but not at 14000H, since the first few integer multiples of a 32K memory block are 0H, 8000H, 10000H, 18000H, etc. After reset, the contents of both of these registers is undefined. However, none of the MCS lines will be active until both the MMCS and MPCS registers are accessed.

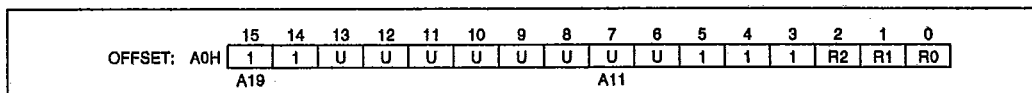

Figure 11. UMCS Register

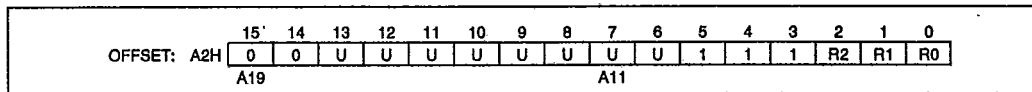

Figure 12. LMCS Register



T-49-17-15

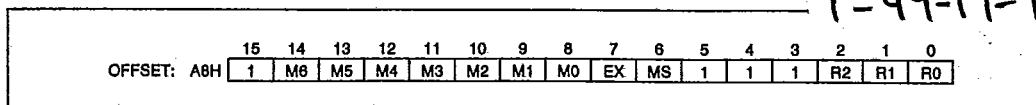

Figure 13. MPCS Register

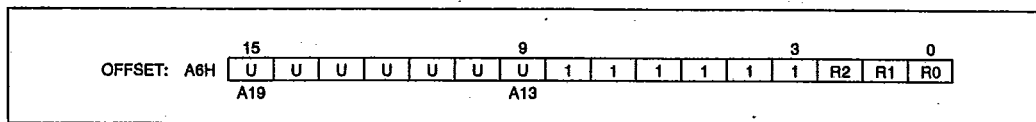

Figure 14. MMCS Register

MMCS bits R2–R0 specify READY mode of operation for all mid-range chip selects. All devices in mid-range memory must use the same number of WAIT states.

The 512K block size for the mid-range memory chip selects is a special case. When using 512K, the base address would have to be at either locations 00000H or 80000H. If it were to be programmed at 00000H when the \overline{LCS} line was programmed, there would be an internal conflict between the \overline{LCS} ready generation logic and the \overline{MCS} ready generation logic. Likewise, if the base address were programmed at 80000H, there would be a conflict with the \overline{UCS} ready generation logic. Since the \overline{LCS} chip-select line does not become active until programmed, while the \overline{UCS} line is active at reset, the memory base can be set only at 00000H. If this base address is selected, however, the \overline{LCS} range must not be programmed.

Peripheral Chip Selects

The M80186 can generate chip selects for up to seven peripheral devices. These chip selects are active for seven contiguous blocks of 128 bytes above a programmable base address. This base address may be located in either memory or I/O space.

Seven \overline{CS} lines called $\overline{PCS0}$ – $\overline{6}$ are generated by the M80186. The base address is user-programma-

ble; however it can only be a multiple of 1K bytes, i.e., the least significant 10 bits of the starting address are always 0.

$\overline{PCS5}$ and $\overline{PCS6}$ can also be programmed to provide latched address bits A1, A2. If so programmed, they cannot be used as peripheral selects. These outputs can be connected directly to the A0, A1 pins used for selecting internal registers of 8-bit peripheral chips. This scheme simplifies the hardware interface because the 8-bit registers of peripherals are simply treated as 16-bit registers located on even boundaries in I/O space or memory space where only the lower 8-bits of the register are significant: the upper 8-bits are "don't cares."

The starting address of the peripheral chip-select block is defined by the PACS register (see Figure 15). This register is located at offset A4H in the internal control block. Bits 15–6 of this register correspond to bits 19–10 of the 20-bit Programmable Base Address (PBA) of the peripheral chip-select block. Bits 9–0 of the PBA of the peripheral chip-select block are all zeros. If the chip-select block is located in I/O space, bits 12–15 must be programmed zero, since the I/O address is only 16 bits wide. Table 10 shows the address range of each peripheral chip select with respect to the PBA contained in PACS register.

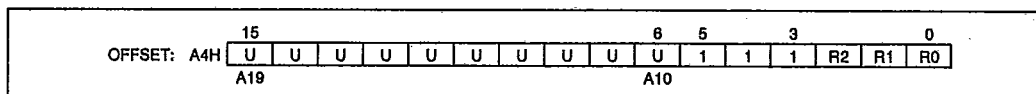

Figure 15. PACS Register



T-49-17-15

The user should program bits 15–6 to correspond to the desired peripheral base location. PACS bits 0–2 are used to specify READY mode for $\overline{PSC0}$ – $\overline{PSC3}$.

Table 10. PCS Address Ranges

| PCS Line | Active between Locations |
|----------|--------------------------|
| PCS0 | PBA —PBA + 127 |
| PCS1 | PBA + 128—PBA + 255 |
| PCS2 | PBA + 256—PBA + 383 |
| PCS3 | PBA + 384—PBA + 511 |
| PCS4 | PBA + 512—PBA + 639 |
| PCS5 | PBA + 640—PBA + 767 |
| PCS6 | PBA + 768—PBA + 895 |

The mode of operation of the peripheral chip selects is defined by the MPCS register (which is also used to set the size of the mid-range memory chip-select block, see Figure 16). This register is located at offset A8H in the internal control block. Bit 7 is used to select the function of PCS5 and PCS6, while bit 6 is used to select whether the peripheral chip selects are mapped into memory or I/O space. Table 11 describes the programming of these bits. After reset, the contents of both the MPCS and the PACS registers are undefined, however none of the PCS lines will be active until both of the MPCS and PACS registers are accessed.

Table 11. MS, EX Programming Values

| Bit | Description |
|-----|---|
| MS | 1 = Peripherals mapped into memory space. 0 = Peripherals mapped into I/O space. |
| EX | 0 = 5 PCS lines. A1, A2 provided. 1 = 7 PCS lines. A1, A2 are not provided. |

MPCS bits 0–2 are used to specify READY mode for $\overline{PCS4}$ – $\overline{PCS6}$ as outlined below.

READY Generation Logic

The M80186 can generate a "READY" signal internally for each of the memory or peripheral CS lines. The number of WAIT states to be inserted for each peripheral or memory is programmable to provide 0–3 wait states for all accesses to the area for which the chip select is active. In addition, the M80186 may be programmed to either ignore external READY for each chip-select range individually or to factor external READY with the integrated ready generator.

READY control consists of 3 bits for each CS line or group of lines generated by the M80186. The interpretation of the ready bits is shown in Table 12.

Table 12. READY Bits Programming

| R2 | R1 | R0 | Number of WAIT States Generated |
|----|----|----|---|
| 0 | 0 | 0 | 0 wait states, external RDY also used. |
| 0 | 0 | 1 | 1 wait state inserted, external RDY also used. |
| 0 | 1 | 0 | 2 wait states inserted, external RDY also used. |
| 0 | 1 | 1 | 3 wait states inserted, external RDY also used. |
| 1 | 0 | 0 | 0 wait states, external RDY ignored. |
| 1 | 0 | 1 | 1 wait state inserted, external RDY ignored. |
| 1 | 1 | 0 | 2 wait states inserted, external RDY ignored. |
| 1 | 1 | 1 | 3 wait states inserted, external RDY ignored. |

The internal ready generator operates in parallel with external READY, not in series if the external READY is used (R2 = 0). This means, for example, if the internal generator is set to insert two wait states, but activity on the external READY lines will insert four wait states, the processor will only insert four wait states, not six. This is because the two wait states generated by the internal generator overlapped the first two wait states generated by the external ready signal. Note that the external ARDY and SRDY lines are always ignored during cycles accessing internal peripherals.

R2–R0 of each control word specifies the READY mode for the corresponding block, with the exception of the peripheral chip selects: R2–R0 of PACS set the $\overline{PCS0}$ – $\overline{PCS3}$ READY mode, R2–R0 of MPCS set the $\overline{PCS4}$ – $\overline{PCS6}$ READY mode.

Chip Select/Ready Logic and Reset

Upon reset, the Chip-Select/Ready Logic will perform the following actions:

- All chip-select outputs will be driven HIGH.
- Upon leaving RESET, the \overline{UCS} line will be programmed to provide chip selects to a 1K block with the accompanying READY control bits set at 011 to allow the maximum number of internal wait states in conjunction with external Ready consideration (i.e., UMCS resets to FFFBH).
- No other chip select or READY control registers have any predefined values after RESET. They will not become active until the CPU accesses their control registers. Both the PACS and MPCS registers must be accessed before the PCS lines will become active.



T-49-17-15

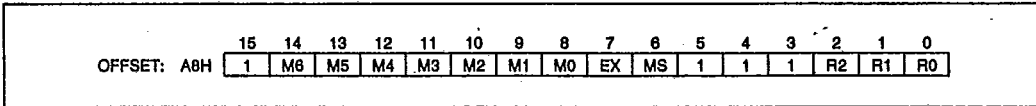

Figure 16. MPCS Register

DMA CHANNELS

The M80186 DMA controller provides two independent high-speed DMA channels. Data transfers can occur between memory and I/O spaces (e.g., Memory to I/O) or within the same space (e.g., Memory to Memory or I/O to I/O). Data can be transferred either in bytes (8 bits) or in words (16 bits) to or from even or odd addresses. Each DMA channel maintains both a 20-bit source and destination pointer which can be optionally incremented or decremented after each data transfer (by one or two depending on byte or word transfers). Each data transfer consumes 2 bus cycles (a minimum of 8 clocks), one cycle to fetch data and the other to store data. This provides a maximum data transfer rate of one Mword/sec or 2 MBytes/sec.

DMA Operation

Each channel has six registers in the control block which define each channel's specific operation. The control registers consist of a 20-bit Source pointer (2

words), a 20-bit destination pointer (2 words), a 16-bit Transfer Counter, and a 16-bit Control Word. The format of the DMA Control Blocks is shown in Table 13. The Transfer Count Register (TC) specifies the number of DMA transfers to be performed. Up to 64K byte or word transfers can be performed with automatic termination. The Control Word defines the channel's operation (see Figure 16). All registers may be modified or altered during any DMA activity. Any changes made to these registers will be reflected immediately in DMA operation.

Table 13. DMA Control Block Format

| Register Name | Register Address | |
|------------------------------------|------------------|-------|
| | Ch. 0 | Ch. 1 |
| Control Word | CAH | DAH |
| Transfer Count | C8H | D8H |
| Destination Pointer (upper 4 bits) | C6H | D6H |
| Destination Pointer | C4H | D4H |
| Source Pointer (upper 4 bits) | C2H | D2H |
| Source Pointer | C0H | D0H |

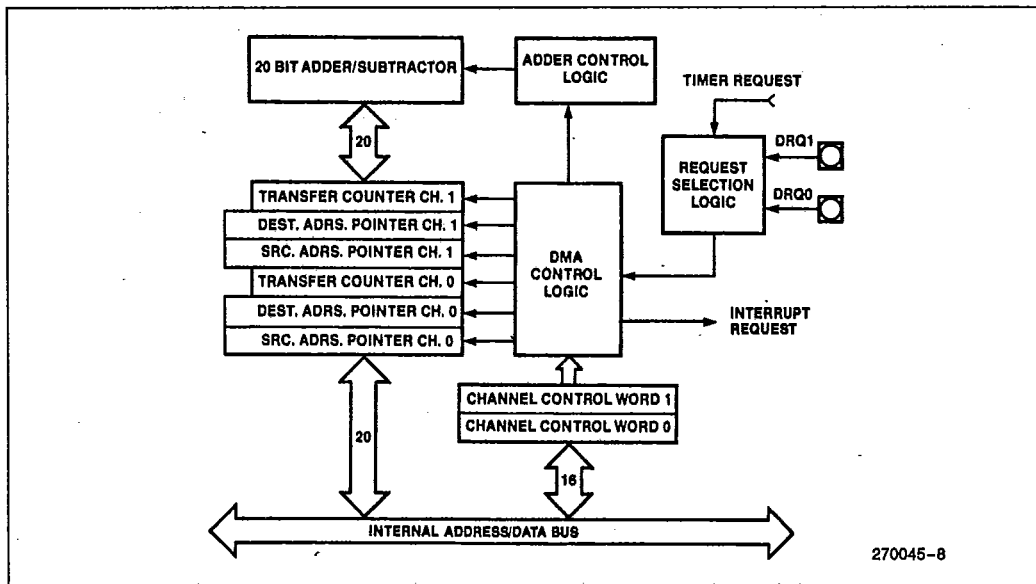

Figure 17. DMA Unit Block Diagram



T-49-17-15

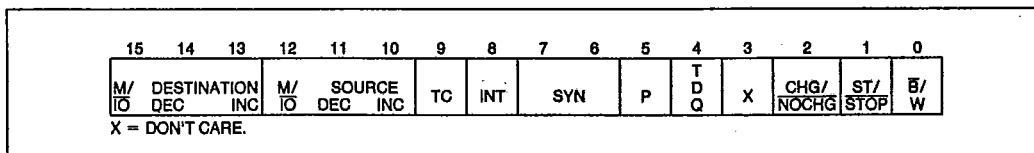

Figure 18. DMA Control Register

DMA Channel Control Word Register

Each DMA Channel Control Word determines the mode of operation for the particular M80186 DMA channel. This register specifies:

- the mode of synchronization;
- whether bytes or words will be transferred;
- whether interrupts will be generated after the last transfer;
- whether DMA activity will cease after a programmed number of DMA cycles;
- the relative priority of the DMA channel with respect to the other DMA channel;
- whether the source pointer will be incremented, decremented, or maintained constant after each transfer;
- whether the source pointer addresses memory or I/O space;
- whether the destination pointer will be incremented, decremented, or maintained constant after each transfer; and
- whether the destination pointer will address memory or I/O space.

The DMA channel control registers may be changed while the channel is operating. However, any changes made during operation will affect the current DMA transfer.

DMA Control Word Bit Descriptions

\bar{B}/W : Byte/Word (0/1) Transfers.

ST/STOP: Start/stop (1/0) Channel.

CHG/NOCHG: Change/Do not change (1/0) ST/STOP bit. If this bit is set when writing to the control word, the ST/STOP bit will be programmed by the write to the control word. If this bit is cleared when writing the control word, the ST/STOP bit will not be altered. This bit is not stored; it will always be a 0 on read.

INT: Enable Interrupts to CPU on Transfer Count termination.

TC:

If set, DMA will terminate when the contents of the Transfer Count register reach zero. The ST/STOP bit will also be reset at this point if TC is set. If this bit is cleared, the DMA unit will decrement the transfer count register for each DMA cycle, but the DMA transfer will not stop when the contents of the TC register reach zero.

SYN
(2 bits)

00 No synchronization.

NOTE: The ST bit will be cleared automatically when the contents of the TC register reach zero regardless of the state of the TC bit.

01 Source synchronization.

10 Destination synchronization.

11 Unused.

SOURCE:INC Increment source pointer by 1 or 2 (depends on \bar{B}/W) after each transfer.

M/I/O Source pointer is in M/I/O space (1/0).

DEC Decrement source pointer by 1 or 2 (depends on \bar{B}/W) after each transfer.

DEST: INC Increment destination pointer by 1 or 2 (\bar{B}/W) after each transfer.

M/I/O Destination pointer is in M/I/O space (1/0).

DEC Decrement destination pointer by 1 or 2 (depending on \bar{B}/W) after each transfer.

P

Channel priority—relative to other channel.

0 low priority.

1 high priority.

Channels will alternate cycles if both set at same priority level.

TDRQ

0: Disable DMA requests from timer 2.

1: Enable DMA requests from timer 2.

Bit 3

Bit 3 is not used.

If both INC and DEC are specified for the same pointer, the pointer will remain constant after each cycle.

T-49-17-15

DMA Destination and Source Pointer Registers

Each DMA channel maintains a 20-bit source and a 20-bit destination pointer. Each of these pointers takes up two full 16-bit registers in the peripheral control block. The lower four bits of the upper register contain the upper four bits of the 20-bit physical address (see Figure 18a). These pointers may be individually incremented or decremented after each transfer. If word transfers are performed the pointer is incremented or decremented by two. Each pointer may point into either memory or I/O space. Since the DMA channels can perform transfers to or from odd addresses, there is no restriction on values for the pointer registers. Higher transfer rates can be obtained if all word transfers are performed to even addresses, since this will allow data to be accessed in a single memory access.

DMA Transfer Count Register

Each DMA channel maintains a 16-bit transfer count register (TC). This register is decremented after every DMA cycle, regardless of the state of the TC bit in the DMA Control Register. If the TC bit in the DMA control word is set or unsynchronized transfers are programmed, however, DMA activity will terminate when the transfer count register reaches zero.

DMA Requests

Data transfers may be either source or destination synchronized, that is either the source of the data or

the destination of the data may request the data transfer. In addition, DMA transfers may be unsynchronized; that is, the transfer will take place continually until the correct number of transfers has occurred. When source or unsynchronized transfers are performed, the DMA channel may begin another transfer immediately after the end of a previous DMA transfer. This allows a complete transfer to take place every 2 bus cycles or eight clock cycles (assuming no wait states). No prefetching occurs when destination synchronization is performed, however. Data will not be fetched from the source address until the destination device signals that it is ready to receive it. When destination synchronized transfers are requested, the DMA controller will relinquish control of the bus after every transfer. If no other bus activity is initiated, another DMA cycle will begin after two processor clocks. This is done to allow the destination device time to remove its request if another transfer is not desired. Since the DMA controller will relinquish the bus, the CPU can initiate a bus cycle. As a result, a complete bus cycle will often be inserted between destination synchronized transfers. These lead to the maximum DMA transfer rates shown in Table 14.

Table 14. Maximum DMA Transfer Rates

| Type of Synchronization Selected | CPU Running | CPU Halted |
|----------------------------------|---------------|--------------|
| Unsynchronized | 2MBytes/sec | 2MBytes/sec |
| Source Synch | 2MBytes/sec | 2MBytes/sec |
| Destination Synch | 1.3MBytes/sec | 1.5MByte/sec |

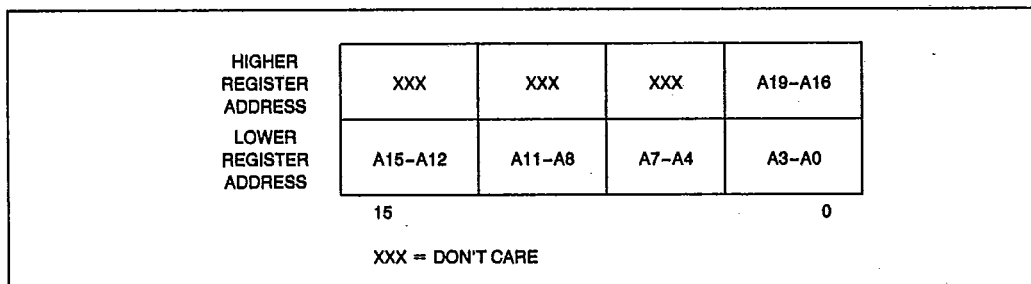

Figure 18a. DMA Memory Pointer Register Format

T-49-17-15

DMA Acknowledge

No explicit DMA acknowledge pulse is provided. Since both source and destination pointers are maintained, a read from a requesting source, or a write to a requesting destination, should be used as the DMA acknowledge signal. Since the chip-select lines can be programmed to be active for a given block of memory or I/O space, and the DMA pointers can be programmed to point to the same given block, a chip-select line could be used to indicate a DMA acknowledge.

DMA Priority

The DMA channels may be programmed such that one channel is always given priority over the other, or they may be programmed such as to alternate cycles when both have DMA requests pending. DMA cycles always have priority over internal CPU cycles except between locked memory accesses or word accesses the odd memory locations; however, an external bus hold takes priority over an internal DMA cycle. Because an interrupt request cannot suspend a DMA operation and the CPU cannot access memory during a DMA cycle, interrupt latency time will suffer during sequences of continuous DMA cycles. An NMI request, however, will cause all internal DMA activity to halt. This allows the CPU to quickly respond to the NMI request.

DMA Programming

DMA cycles will occur whenever the ST/STOP bit of the Control Register is set. If synchronized transfers

are programmed, a DRQ must also have been generated. Therefore the source and destination transfer pointers, and the transfer count register (if used) must be programmed before this bit is set.

Each DMA register may be modified while the channel is operating. If the CHG/NOCHG bit is cleared when the control register is written, the ST/STOP bit of the control register will not be modified by the write. If multiple channel registers are modified, it is recommended that a LOCKED string transfer be used to prevent a DMA transfer from occurring between updates to the channel registers.

DMA Channels and Reset

Upon RESET, the DMA channels will perform the following actions:

- The Start/Stop bit for each channel will be reset to STOP.
- Any transfer in progress is aborted.

TIMERS

The M80186 provides three internal 16-bit programmable timers (see Figure 19). Two of these are highly flexible and are connected to four external pins (2 per timer). They can be used to count external events, time external events, generate nonrepetitive waveforms, etc. The third timer is not connected to any external pins, and is useful for real-time coding and time delay applications. In addition, this third timer can be used as a prescaler to the other two, or as a DMA request source.

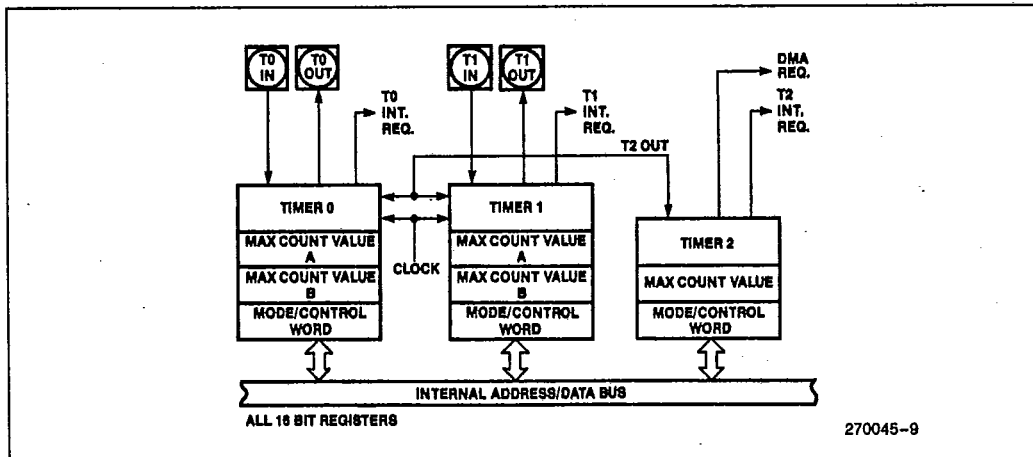

Figure 19. Timer Block Diagram



T-49-17-15

Timer Operation

The timers are controlled by 11 16-bit registers in the internal peripheral control block. The configuration of these registers is shown in Table 15. The count register contains the current value of the timer. It can be read or written at any time independent of whether the timer is running or not. The value of this register will be incremented for each timer event. Each of the timers is equipped with a MAX COUNT register, which defines the maximum count the timer will reach. After reaching the MAX COUNT register value, the timer count value will reset to zero during that same clock, i.e., the maximum count value is never stored in the count register itself. Timers 0 and 1 are, in addition, equipped with a second MAX COUNT register, which enables the timers to alternate their count between two different MAX COUNT values programmed by the user. If a single MAX COUNT register is used, the timer output pin will switch LOW for a single clock, 1 clock after the maximum count value has been reached. In the dual MAX COUNT register mode, the output pin will indicate which MAX COUNT register is currently in use, thus allowing nearly complete freedom in selecting waveform duty cycles. For the timers with two MAX COUNT registers, the RIU bit in the control register determines which is used for the comparison.

Each timer gets serviced every fourth CPU-clock cycle, and thus can operate at speeds up to one-quarter the internal clock frequency (one-eighth the crystal rate). External clocking of the timers may be done at up to a rate of one-quarter of the internal CPU-clock rate (2 MHz for an 8 MHz CPU clock). Due to internal synchronization and pipelining of the timer circuitry, a timer output may take up to 6 clocks to respond to any individual clock or gate input.

Since the count registers and the maximum count registers are all 16 bits wide, 16 bits of resolution are provided. Any Read or Write access to the timers will add one wait state to the minimum four-clock bus cycle, however. This is needed to synchronize and coordinate the internal data flows between the internal timers and the internal bus.

The timers have several programmable options.

- All three timers can be set to halt or continue on a terminal count.
- Timers 0 and 1 can select between internal and external clocks, alternate between MAX COUNT registers and be set to retrigger on external events.
- The timers may be programmed to cause an interrupt on terminal count.

These options are selectable via the timer mode/control word.

Timer Mode/Control Register

The mode/control register (see Figure 20) allows the user to program the specific mode of operation or check the current programmed status for any of the three integrated timers.

Table 15. Timer Control Block Format

| Register Name | Register Offset | | |
|-------------------|-----------------|--------|-------------|
| | Tmr. 0 | Tmr. 1 | Tmr. 2 |
| Mode/Control Word | 56H | 5EH | 66H |
| Max Count B | 54H | 5CH | not present |
| Max Count A | 52H | 5AH | 62H |
| Count Register | 50H | 58H | 60H |

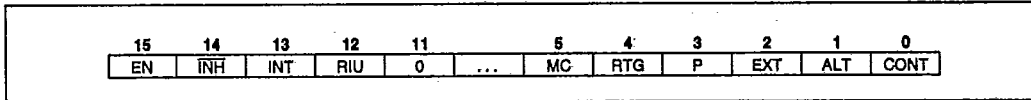

Figure 20. Timer Mode/Control Register



T-49-17-15

ALT:

The ALT bit determines which of two MAX COUNT registers is used for count comparison. If ALT = 0, register A for that timer is always used, while if ALT = 1, the comparison will alternate between register A and register B when each maximum count is reached. This alternation allows the user to change one MAX COUNT register while the other is being used, and thus provides a method of generating non-repetitive waveforms. Square waves and pulse outputs of any duty cycle are a subset of available signals obtained by not changing the final count registers. The ALT bit also determines the function of the timer output pin. If ALT is zero, the output pin will go LOW for one clock, the clock after the maximum count is reached. If ALT is one, the output pin will reflect the current MAX COUNT register being used (0/1 for B/A).

CONT:

Setting the CONT bit causes the associated timer to run continuously, while resetting it causes the timer to halt upon maximum count. If COUNT = 0 and ALT = 1, the timer will count to the MAX COUNT register A value, reset, count to the register B value, reset, and halt.

EXT:

The external bit selects between internal and external clocking for the timer. The external signal may be asynchronous with respect to the M80186 clock. If this bit is set, the timer will count LOW-to-HIGH transitions on the input pin. If cleared, it will count an internal clock while using the input pin for control. In this mode, the function of the external pin is defined by the RTG bit. The maximum input to output transition latency time may be as much as 6 clocks. However, clock inputs may be pipelined as closely together as every 4 clocks without losing clock pulses.

P:

The prescaler bit is ignored unless internal clocking has been selected (EXT = 0). If the P bit is a zero, the timer will count at one-fourth the internal CPU clock rate. If the P bit is a one, the output of timer 2 will be used as a clock for the timer. Note that the user must initialize and start timer 2 to obtain the prescaled clock.

RTG:

Retrigger bit is only active for internal clocking (EXT = 0). In this case it determines the control function provided by the input pin.

If RTG = 0, the input level gates the internal clock on and off. If the input pin is HIGH, the timer will count; if the input pin is LOW, the timer will hold its value. As indicated previously, the input signal may be asynchronous with respect to the M80186 clock.

When RTG = 1, the input pin detects LOW-to-HIGH transitions. The first such transition starts the timer running, clearing the timer value to zero on the first clock, and then incrementing thereafter. Further transitions on the input pin will again reset the timer to zero, from which it will start counting up again. If CONT = 0, when the timer has reached maximum count, the EN bit will be cleared, inhibiting further timer activity.

EN:

The enable bit provides programmer control over the timer's RUN/HALT status. When set, the timer is enabled to increment subject to the input pin constraints in the internal clock mode (discussed previously). When cleared, the timer will be inhibited from counting. All input pin transitions during the time EN is zero will be ignored. If CONT is zero, the EN bit is automatically cleared upon maximum count.

INH:

The inhibit bit allows for selective updating of the enable (EN) bit. If INH is a one during the write to the mode/control word, then the state of the EN bit will be modified by the write. If INH is a zero during the write, the EN bit will be unaffected by the operation. This bit is not stored; it will always be a 0 on a read.

INT:

When set, the INT bit enables interrupts from the timer, which will be generated on every terminal count. If the timer is configured in dual MAX COUNT register mode, an interrupt will be generated each time the value in MAX COUNT register A is reached, and each time the value in MAX COUNT register B is reached. If this enable bit is cleared after the interrupt request has been generated, but before a pending interrupt is serviced, the interrupt request will still be in force. (The request is latched in the Interrupt Controller).

MC:

The Maximum Count bit is set whenever the timer reaches its final maximum count value. If the timer is configured in dual MAX COUNT register mode, this bit will be set each time the value in MAX COUNT register A is reached, and each time the value in MAX COUNT register B is reached. This bit is set



T-49-17-15

regardless of the timer's interrupt-enable bit. The MC bit gives the user the ability to monitor timer status through software instead of through interrupts.

Programmer intervention is required to clear this bit.

RIU:

The Register In Use bit indicates which MAX COUNT register is currently being used for comparison to the timer count value. A zero value indicates register A. The RIU bit cannot be written, i.e., its value is not affected when the control register is written. It is always cleared when the ALT bit is zero.

Not all mode bits are provided for timer 2. Certain bits are hardwired as indicated below:

ALT = 0, EXT = 0, P = 0, RTG = 0, RIU = 0

Count Registers

Each of the three timers has a 16-bit count register. The current contents of this register may be read or written by the processor at any time. If the register is written into while the timer is counting, the new value will take effect in the current count cycle.

Max Count Registers

Timers 0 and 1 have two MAX COUNT registers, while timer 2 has a single MAX COUNT register. These contain the number of events the timer will count. In timers 0 and 1, the MAX COUNT register used can alternate between the two max count values whenever the current maximum count is reached. The condition which causes a timer to reset is equivalent between the current count value and the max count being used. This means that if the count is changed to be above the max count value, or if the max count value is changed to be below the current value, the timer will not reset to zero, but rather will count to its maximum value, "wrap around" to zero, then count until the max count is reached.

Timers and Reset

Upon RESET, the Timers will perform the following actions:

- All EN (Enable) bits are reset preventing timer counting.
- All SEL (Select) bits are reset to zero. This selects MAX COUNT register A, resulting in the Timer Out pins going HIGH upon RESET.

INTERRUPT CONTROLLER

The M80186 can receive interrupts from a number of sources, both internal and external. The internal interrupt controller serves to merge these requests on a priority basis, for individual service by the CPU.

Internal interrupt sources (Timers and DMA channels) can be disabled by their own control registers or by mask bits within the interrupt controller. The M80186 interrupt controller has its own control register that set the mode of operation for the controller.

The interrupt controller will resolve priority among requests that are pending simultaneously. Nesting is provided so interrupt service routines for lower priority interrupts may themselves be interrupted by higher priority interrupts. A block diagram of the interrupt controller is shown in Figure 21.

The interrupt controller has a special MiRMX 86 compatibility mode that allows the use of the M80186 within the MiRMX 86 operating system interrupt structure. The controller is set in this mode by setting bit 14 in the peripheral control block relocation register (see MiRMX 86 Compatibility Mode section). In this mode, the internal M80186 interrupt controller functions as a "slave" controller to an external "master" controller. Special initialization software must be included to properly set up the M80186 interrupt controller in MiRMX 86 mode.

MASTER MODE OPERATION

Interrupt Controller External Interface

For external interrupt sources, five dedicated pins are provided. One of these pins is dedicated to NMI, non-maskable interrupt. This is typically used for power-fail interrupts, etc. The other four pins may function either as four interrupt input lines with internally generated interrupt vectors, as an interrupt line and an interrupt acknowledge line (called the "cascade mode") along with two other input lines with internally generated interrupt vectors, or as two interrupt input lines and two dedicated interrupt acknowledge output lines. When the interrupt lines are configured in cascade mode, the M80186 interrupt controller will not generate internal interrupt vectors.

External sources in the cascade mode use externally generated interrupt vectors. When an interrupt is acknowledged, two INTA cycles are initiated and the vector is read into the M80186 on the second cycle. The capability to interface to external M8259A programmable interrupt controllers is thus provided when the inputs are configured in cascade mode.



T-49-17-15

Interrupt Controller Modes of Operation

The basic modes of operation of the interrupt controller in master mode are similar to the M8259A. The interrupt-controller responds indentially to internal interrupts in all three modes: the difference is only in the interpretation of function of the four external interrupt pins. The interrupt controller is set into one of these three modes by programming the correct bits in the INT0 and INT1 control registers. The modes of interrupt controller operation are as follows:

Fully Nested Mode

When in the fully nested mode four pins are used as direct interrupt requests. The vectors for these four inputs are generated internally. An in-service bit is provided for every interrupt source. If a lower-priority device requests an interrupt while the in service bit (IS) is set, no interrupt will be generated by the interrupt controller. In addition, if another interrupt request occurs from the same interrupt source while the in-service bit is set, no interrupt will be generated by the interrupt controller. This allows interrupt service routines to operate with interrupts enabled without being themselves interrupted by lower-priority interrupts. Since interrupts are enabled, higher-priority interrupts will be serviced.

When a service routine is completed, the proper IS bit must be reset by writing the proper pattern to the EOI register. This is required to allow subsequent interrupts from this interrupt source and to allow servicing of lower-priority interrupts. An EOI com-

mand is issued at the end of the service routine just before the issuance of the return from interrupt instruction. If the fully nested structure has been upheld, the next highest-priority source with its IS bit set is then serviced.

Cascade Mode

The M80186 has four interrupt pins and two of them have dual functions. In the fully nested mode the four pins are used as direct interrupt inputs and the corresponding vectors are generated internally. In the cascade mode, the four pins are configured into interrupt input-dedicated acknowledge signal pairs. The interconnection is shown in Figure 22. INT0 is an interrupt input interfaced to an M8259A, while INT2/INTA0 serves as the dedicated interrupt acknowledge signal to that peripheral. The same is true for INT1 and INT3/INTA1. Each pair can selectively be placed in the cascade or non-cascade mode by programming the proper value into INT0 and INT1 control registers. The use of the dedicated acknowledge signals eliminates the need for the use of external logic to generate INTA and device select signals.

The primary cascade mode allows the capability to serve up to 128 external interrupt sources through the use of external master and slave M8259As. Three levels of priority are created, requiring priority resolution in the M80186 interrupt controller, the master M8259As, and the slave M8259As. If an external interrupt is serviced, one IS bit is set at each of these levels. When the interrupt service routine is completed, up to three end-of-interrupt commands must be issued by the programmer.

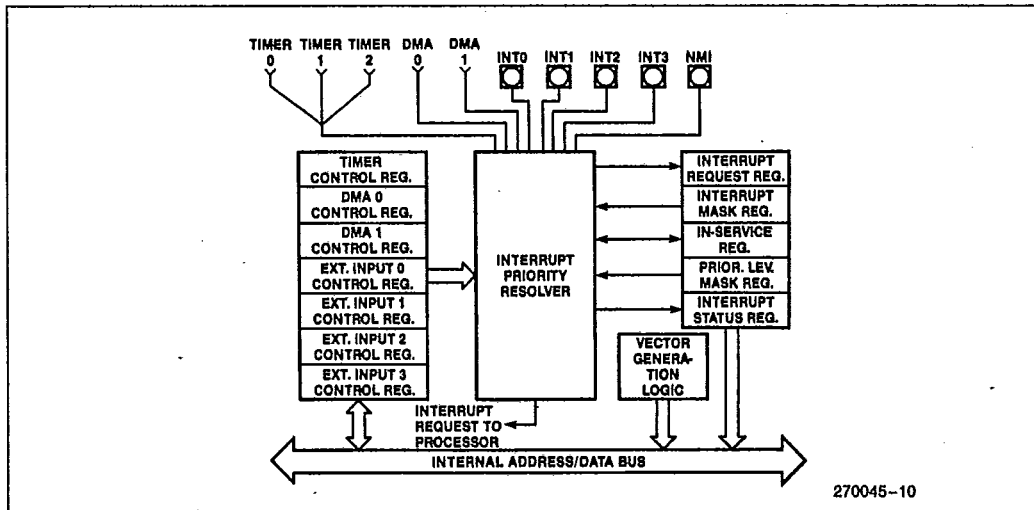

Figure 21. Interrupt Controller Block Diagram



Special Fully Nested Mode

This mode is entered by setting the SFNM bit in INTO or INT1 control register. It enables complete nestability with external M8259A masters. Normally, an interrupt request from an interrupt source will not be recognized unless the in-service bit for that source is reset. If more than one interrupt source is connected to an external interrupt controller, all of the interrupts will be funneled through the same M80186 interrupt request pin. As a result, if the external interrupt controller receives a higher-priority interrupt, its interrupt will not be recognized by the M80186 controller until the M80186 in-service bit is reset. In special fully nested mode, the M80186 interrupt controller will allow interrupts from an external pin regardless of the state of the in-service bit for an interrupt source in order to allow multiple interrupts from a single pin. An in-service bit will continue to be set, however, to inhibit interrupts from other lower-priority M80186 interrupt sources.

Special procedures should be followed when resetting IS bits at the end of interrupt service routines. Software polling of the external master's IS register is required to determine if there is more than one bit set. If so, the IS bit in the M80186 remains active and the next interrupt service routine is entered.

Operation in a Polled Environment

The controller may be used in a polled mode if interrupts are undesirable. When polling, the processor disables interrupts and then polls the interrupt controller whenever it is convenient. Polling the interrupt controller is accomplished by reading the Poll Word (Figure 31). Bit 15 in the poll word indicates to the processor that an interrupt of high enough priority is requesting service. Bits 0-4 indicate to the processor the type vector of the highest-priority source requesting service. Reading the Poll Word causes the In-Service bit of the highest priority source to be set.

It is desirable to be able to read the Poll Word information without guaranteeing service of any pending interrupt, i.e., not set the indicated in-service bit. The M80186 provides a Poll Status Word in addition to the conventional Poll Word to allow this to be done. Poll Word information is duplicated in the Poll Status Word, but reading the Poll Status Word does not set the associated in-service bit. These words are located in two adjacent memory locations in the register file.

Master Mode Features

Programmable Priority

The user can program the interrupt sources into any of eight different priority levels. The programming is done by placing a 3-bit priority level (0-7) in the control register of each interrupt source. (A source with a priority level of 4 has higher priority over all priority levels from 5 to 7. Priority registers containing values lower than 4 have greater priority). All interrupt sources have preprogrammed default priority levels (see Table 4).

If two requests with the same programmed priority level are pending at once, the priority ordering scheme shown in Table 4 is used. If the serviced interrupt routine reenables interrupts, it allows other requests to be serviced.

End-of-Interrupt Command

The end-of-interrupt (EOI) command is used by the programmer to reset the In-Service (IS) bit when an interrupt service routine is completed. The EOI command is issued by writing the proper pattern to the EOI register. There are two types of EOI commands, specific and nonspecific. The nonspecific command does not specify which IS bit is reset. When issued, the interrupt controller automatically resets the IS bit of the highest priority source with an active service routine. A specific EOI command requires that the programmer send the interrupt vector type to the interrupt controller indicating which source's IS bit is to be reset. This command is used when the fully nested structure has been disturbed or the highest priority IS bit that was set does not belong to the service routine in progress.

Trigger Mode

The four external interrupt pins can be programmed in either edge- or level-trigger mode. The control register for each external source has a level-trigger mode (LTM) bit. All interrupt inputs are active HIGH. In the edge sense mode or the level-trigger mode, the interrupt request must remain active (HIGH) until the interrupt request is acknowledged by the M80186 CPU. In the edge-sense mode, if the level remains high after the interrupt is acknowledged, the input is disabled and no further requests will be generated. The input level must go LOW for at least one clock cycle to reenable the input. In the level-trigger mode, no such provision is made: holding the interrupt input HIGH will cause continuous interrupt requests.



T-49-17-15

Interrupt Vectoring

The M80186 Interrupt Controller will generate interrupt vectors for the integrated DMA channels and the integrated Timers. In addition, the Interrupt Controller will generate interrupt vectors for the external interrupt lines if they are not configured in Cascade or Special Fully Nested Mode. The interrupt vectors generated are fixed and cannot be changed (see Table 4).

Interrupt Controller Registers

The Interrupt Controller register model is shown in Figure 23. It contains 15 registers. All registers can both be read or written unless specified otherwise.

In-Service Register

This register can be read from or written into. The format is shown in Figure 24. It contains the In-Service bit for each of the interrupt sources. The In-Service bit is set to indicate that a source's service routine is in progress. When an In-Service bit is set, the interrupt controller will not generate interrupts to the CPU when it receives interrupt requests from devices with a lower programmed priority level. The TMR bit is the In-Service bit for all three timers; the D0 and D1 bits are the In-Service bits for the two DMA channels; the I0-I3 are the In-Service bits for the external interrupt pins. The IS bit is set when the processor acknowledges an interrupt request either by an interrupt acknowledge or by reading the poll register. The IS bit is reset at the end of the interrupt service routine by an end-of-interrupt command issued by the CPU.

Interrupt Request Register

The internal interrupt sources have interrupt request bits inside the interrupt controller. The format of this register is shown in Figure 24. A read from this register yields the status of these bits. The TMR bit is the logical OR of all timer interrupt requests. D0 and D1 are the interrupt request bits for the DMA channels.

The state of the external interrupt input pins is also indicated. The state of the external interrupt pins is not a stored condition inside the interrupt controller, therefore the external interrupt bits cannot be written. The external interrupt request bits show exactly when an interrupt request is given to the interrupt controller, so if edge-triggered mode is selected, the bit in the register will be HIGH only after an inactive-to-active transition. For internal interrupt sources, the register bits are set when a request arrives and are reset when the processor acknowledges the requests.

Mask Register

This is a 16-bit register that contains a mask bit for each interrupt source. The format for this register is shown in Figure 24. A one in a bit position corresponding to a particular source serves to mask the source from generating interrupts. These mask bits are the exact same bits which are used in the individual control registers; programming a mask bit using the mask register will also change this bit in the individual control registers, and vice versa.

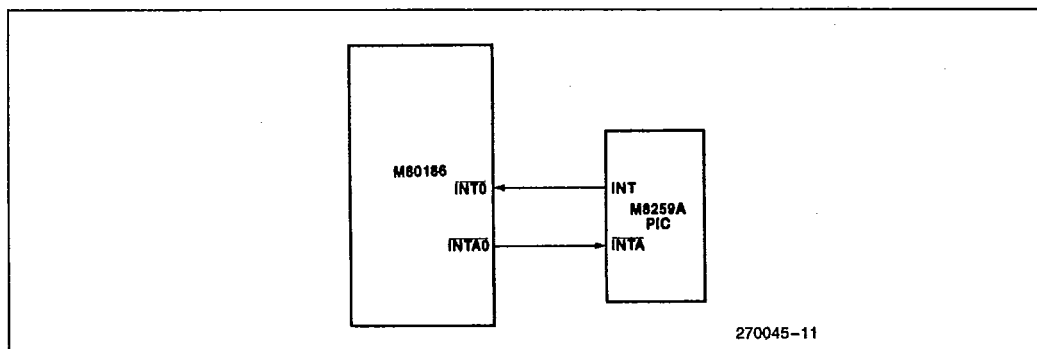

Figure 22. Cascade Mode Interrupt Connection



T-49-17-15

| | OFFSET |
|----------------------------|--------|
| INT3 CONTROL REGISTER | 3EH |
| INT2 CONTROL REGISTER | 3CH |
| INT1 CONTROL REGISTER | 3AH |
| INT0 CONTROL REGISTER | 38H |
| DMA 1 CONTROL REGISTER | 36H |
| DMA 0 CONTROL REGISTER | 34H |
| TIMER CONTROL REGISTER | 32H |
| INTERRUPT STATUS REGISTER | 30H |
| INTERRUPT REQUEST REGISTER | 2EH |
| IN-SERVICE REGISTER | 2CH |
| PRIORITY MASK REGISTER | 2AH |
| MASK REGISTER | 28H |
| POLL STATUS REGISTER | 26H |
| POLL REGISTER | 24H |
| EOI REGISTER | 22H |

Figure 23. Interrupt Controller Registers (Non-MIRM™ 86 Mode)

Priority Mask Register

This register is used to mask all interrupts below particular interrupt priority levels. The format of this register is shown in Figure 25. The code in the lower three bits of this register inhibits interrupts of priority lower (a higher priority number) than the code specified. For example, 100 written into this register masks interrupts of level five (101), six (110), and seven (111). The register is reset to seven (111) upon RESET so all interrupts are unmasked.

Interrupt Status Register

This register contains general interrupt controller status information. The format of this register is shown in Figure 26. The bits in the status register have the following functions:

DHLT: DMA Halt Transfer; setting this bit halts all DMA transfers. It is automatically set whenever a non-maskable interrupt occurs, and it is reset when an IRET instruction is executed. The purpose of this bit is to allow prompt service of all non-maskable interrupts. This bit may also be set by the CPU.

IRTx: These three bits represent the individual timer interrupt request bits. These bits are used to differentiate the timer interrupts, since the timer IR bit in the interrupt request register is the "OR" function of all timer interrupt request. Note that setting any one of these three bits initiates an interrupt request to the interrupt controller.

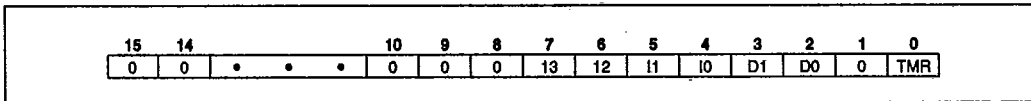

Figure 24. In-Service, Interrupt Request, and Mask Register Formats

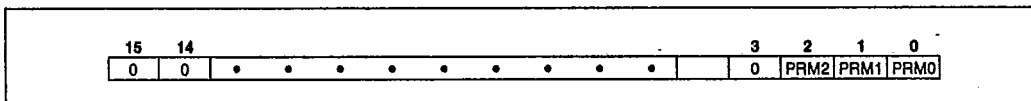

Figure 25. Priority Mask Register Format

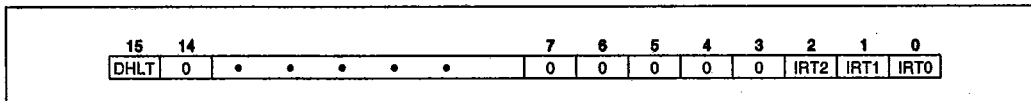

Figure 26. Interrupt Status Register Format



T-49-17-15

Timer, DMA 0, 1; Control Register

These registers are the control words for all the internal interrupt sources. The format for these registers is shown in Figure 27. The three bit positions PR0, PR1, and PR2 represent the programmable priority level of the interrupt source. The MSK bit inhibits interrupt requests from the interrupt source. The MSK bits in the individual control registers are the exact same bits as are in the Mask Register; modifying them in the individual control registers will also modify them in the Mask Register, and vice versa.

interrupt is generated whenever the external line is high. In edge-triggered mode, an interrupt will be generated only when this level is preceded by an inactive-to-active transition on the line. In both cases, the level must remain active until the interrupt is acknowledged.

- MSK: Mask bit, 1 = mask; 0 = non-mask.
- C: Cascade mode bit, 1 = cascade; 0 = direct
- SFNM: Special fully nested mode bit, 1 = SFNM

INT0-INT3 Control Registers

These registers are the control words for the four external input pins. Figure 28 shows the format of the INT0 and INT1 Control registers; Figure 29 shows the format of the INT2 and INT3 Control registers. In cascade mode or special fully nested mode, the control words for INT2 and INT3 are not used.

EOI Register

The end of the interrupt register is a command register which can only be written into. The format of this register is shown in Figure 30. It initiates an EOI command when written to by the M80186 CPU.

The bits in the EOI register are encoded as follows:

- S_x: Encoded information that specifies an interrupt source vector type as shown in Table 4. For example, to reset the In-Service bit for DMA channel 0, these bits should be set to 01010, since the vector type for DMA channel 0 is 10. Note that to reset the single In-Service bit for any of the three timers, the vector type for timer 0 (8) should be written in this register.

The bits in the various control registers are encoded as follows:

- PRO-2: Priority programming information. Highest Priority = 000, Lowest Priority = 111
- LTM: Level-trigger mode bit. 1 = level-triggered; 0 = edge-triggered. Interrupt input levels are active high. In level-triggered mode, an

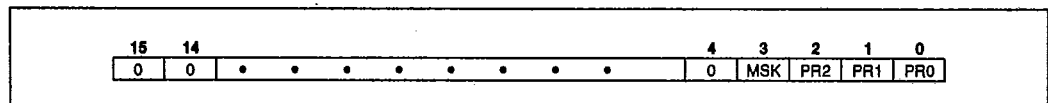

Figure 27. Timer/DMA Control Registers Formats

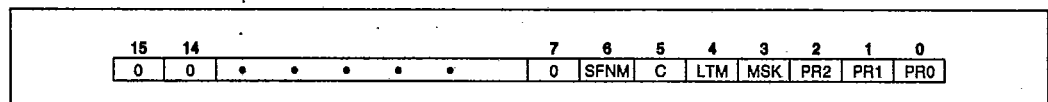

Figure 28. INT0/INT1 Control Register Formats

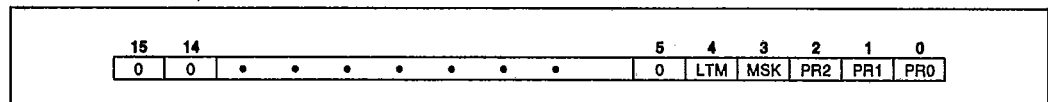

Figure 29. INT2/INT3 Control Register Formats



T-49-17-15

NSPEC/: A bit that determines the type of EOI command. Nonspecific = 1, Specific = 0.

Poll and Poll Status Registers

These registers contain polling information. The format of these registers is shown in Figure 31. They can only be read. Reading the Poll register constitutes a software poll. This will set the IS bit of the highest priority pending interrupt. Reading the poll status register will not set the IS bit of the highest priority pending interrupt; only the status of pending interrupts will be provided.

Encoding of the Poll and Poll Status register bits are as follows:

S_x: Encoded information that indicates the vector type of the highest priority interrupting source. Valid only when INTREQ = 1.

INTREQ: This bit determines if an interrupt request is present. Interrupt Request = 1; no interrupt Request = 0.

IRMXTM 86 COMPATIBILITY MODE

This mode allows MiRMX 86-M80186 compatibility. The interrupt model of MiRMX 86 requires one master and multiple slave M8259As in cascaded fashion. When iRMX mode is used, the internal M80186 interrupt controller will be used as a slave controller to an external master interrupt controller. The internal M80186 resources will be monitored through the internal interrupt controller, while the external controller functions as the system master interrupt controller.

Upon reset, the M80186 interrupt controller will be in the non-MiRMX 86 mode of operation. To set the controller in the MiRMX 86 mode, bit 14 of the Relocation Register should be set.

Because of pin limitations caused by the need to interface to an external M8259A master, the internal interrupt controller will no longer accept external inputs. There are however, enough M80186 interrupt controller inputs (internally) to dedicate one to each timer. In this mode, each timer interrupt source has its own mask bit, IS bit, and control word.

The MiRMX 86 operating system requires peripherals to be assigned fixed priority levels. This is incompatible with the normal operation of the M80186 interrupt controller. Therefore, the initialization software must program the proper priority levels for each source. The required priority levels for the internal interrupt sources in MiRMX mode are shown in Table 16.

Table 16. Internal Source Priority Level

| Priority Level | Interrupt Source |
|----------------|------------------|
| 0 | Timer 0 |
| 1 | (reserved) |
| 2 | DMA 0 |
| 3 | DMA 1 |
| 4 | Timer 1 |
| 5 | Timer 2 |

These level assignments must remain fixed in the MiRMX 86 mode of operation.

MiRMXTM 86 Mode External Interface

The configuration of the M80186 with respect to an external M8259A master is shown in Figure 32. The INT0 input is used as the M80186 CPU interrupt input. INT3 functions as an output to send the M80186 slave-interrupt-request to one of the 8 master-PIC-inputs.

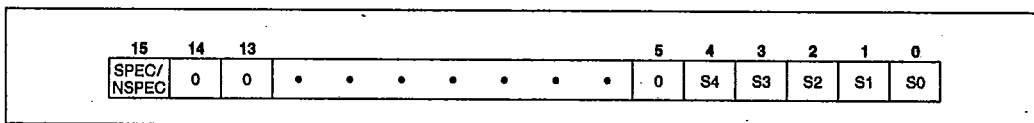

Figure 30. EOI Register Format

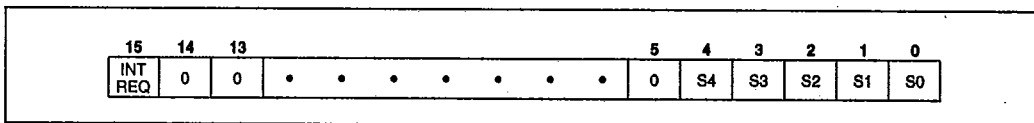

Figure 31. Poll Register Format



T-49-17-15

In-Service Register

This register can be read from or written into. It contains the in-service bit for each of the internal interrupt sources. The format for this register is shown in Figure 35. Bit positions 2 and 3 correspond to the DMA channels; positions 0, 4, and 5 correspond to the integral timers. The source's IS bit is set when the processor acknowledges its interrupt request.

Interrupt Request Register

This register indicates which internal peripherals have interrupt requests pending. The format of this register is shown in Figure 35. The interrupt request bits are set when a request arrives from an internal source, and are reset when the processor acknowledges the request.

Mask Register

The register contains a mask bit for each interrupt source. The format for this register is shown in Figure 35. If the bit in this register corresponding to a particular interrupt source is set, any interrupts from that source will be masked. These mask bits are exactly the same bits which are used in the individual control registers, i.e., changing the state of a mask bit in this register will also change the state of the mask bit in the individual interrupt control register corresponding to the bit.

Control Registers

These registers are the control words for all the internal interrupt sources. The format of these registers is shown in Figure 36. Each of the timers and both of the DMA channels have their own Control Register.

The bits of the Control Registers are encoded as follows:

- pr_x: 3-bit encoded field indicating a priority level for the source; note that each source must be programmed at specified levels.
- msk: mask bit for the priority level indicated by pr_x bits.

| | OFFSET |
|------------------------------------|--------|
| LEVEL 5 CONTROL REGISTER (TIMER 2) | 3AH |
| LEVEL 4 CONTROL REGISTER (TIMER 1) | 38H |
| LEVEL 3 CONTROL REGISTER (DMA 1) | 36H |
| LEVEL 2 CONTROL REGISTER (DMA 0) | 34H |
| LEVEL 0 CONTROL REGISTER (TIMER 0) | 32H |
| INTERRUPT STATUS REGISTER | 30H |
| INTERRUPT-REQUEST REGISTER | 2EH |
| IN-SERVICE REGISTER | 2CH |
| PRIORITY-LEVEL MASK REGISTER | 2AH |
| MASK REGISTER | 28H |
| SPECIFIC EOI REGISTER | 22H |
| INTERRUPT VECTOR REGISTER | 20H |

Figure 33. Interrupt Controller Registers (MIRMXTM 86 Mode)

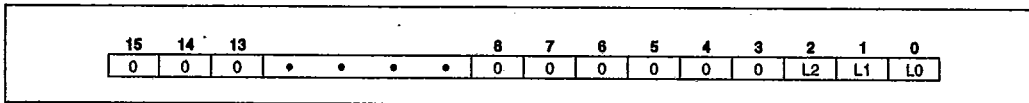

Figure 34. Specific EOI Register Format

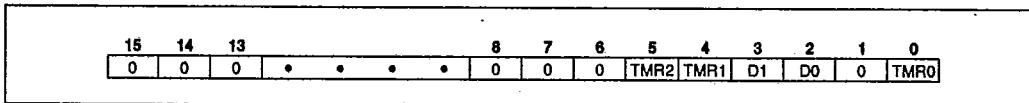

Figure 35. In-Service, Interrupt Request, and Mask Register Format



T-49-17-15

Interrupt Vector Register

This register provides the upper five bits of the interrupt vector address. The format of this register is shown in Figure 37. The interrupt controller itself provides the lower three bits of the interrupt vector as determined by the priority level of the interrupt request.

The format of the bits in this register is:

t_x : 5-bit field indicating the upper five bits of the vector address.

Priority-Level Mask Register

This register indicates the lowest priority-level interrupt which will be serviced.

The encoding of the bits in this register is:

m_x : 3-bit encoded field indicating priority-level value. All levels of lower priority will be masked.

Interrupt Controller and Reset

Upon RESET, the interrupt controller will perform the following actions:

- All SFNM bits reset to 0, implying Fully Nested Mode.
- All PR bits in the various control registers set to 1. This places all sources at lowest priority (level 111).
- All LTM bits reset to 0, resulting in edge-sense mode.
- All Interrupt Service bits reset to 0.
- All Interrupt Request bits reset to 0.
- All MSK (Interrupt Mask) bits set to 1 (mask).
- All C (Cascade) bits reset to 0 (non-cascade).
- All PRM (Priority Mask) bits set to 1, implying no levels masked.
- Initialized to non-MiRMX 86 mode.

Interrupt Status Register

This register is defined exactly as in Non-MiRMX Mode. (See Figure 26.)

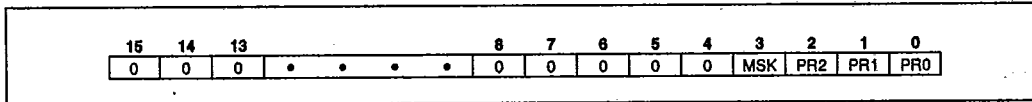

Figure 36. Control Word Format

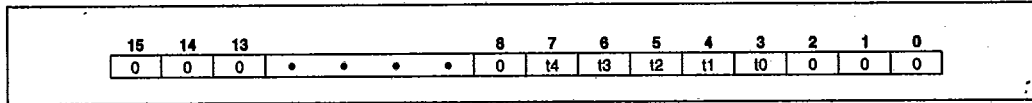

Figure 37. Interrupt Vector Register Format

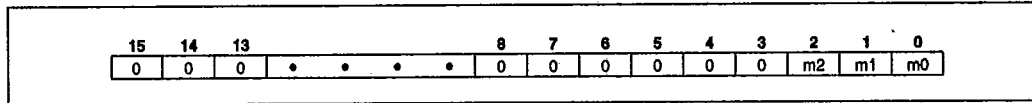
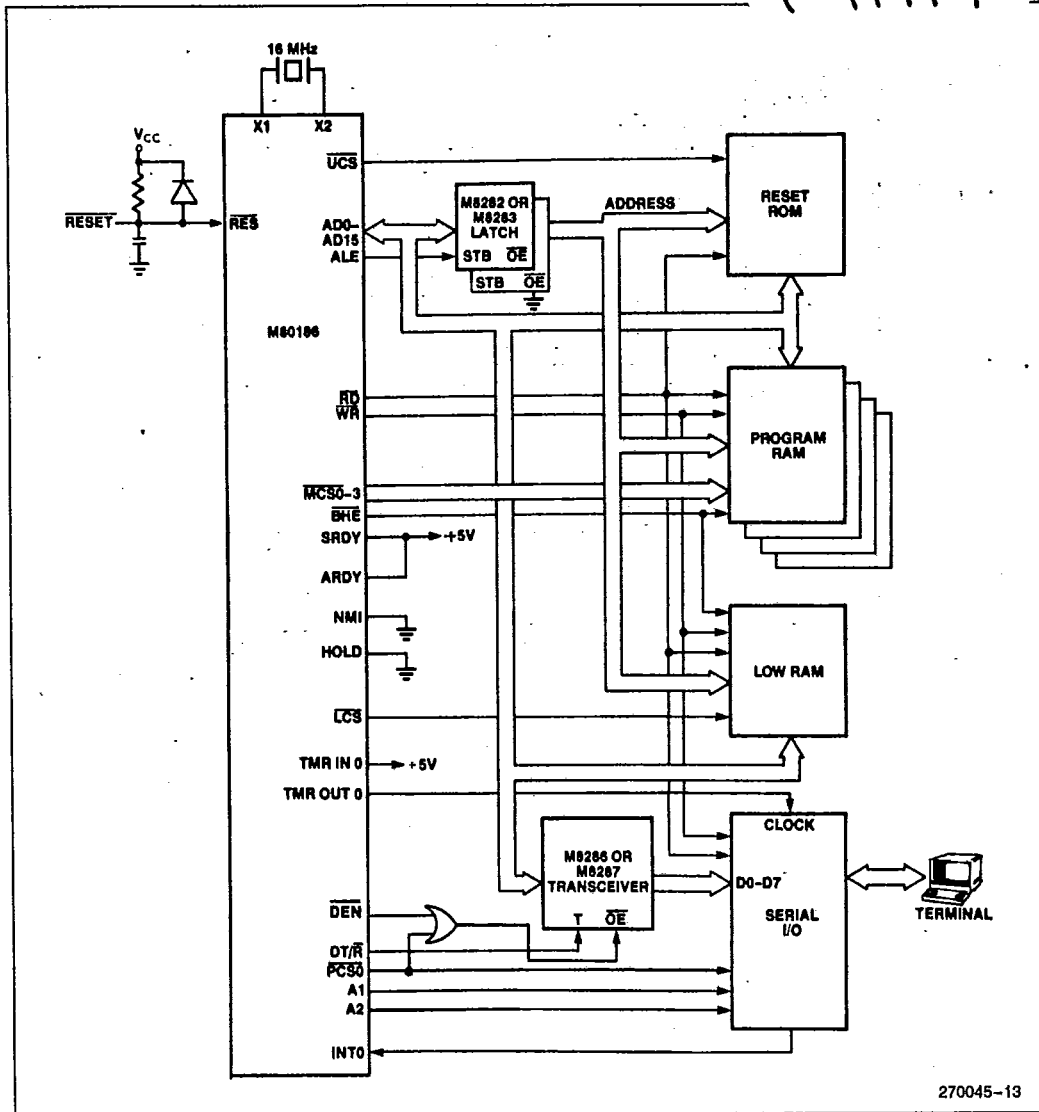

Figure 38. Priority Level Mask Register



T-49-17-15



270045-13

Figure 39. Typical M80186 Computer



T-49-17-15

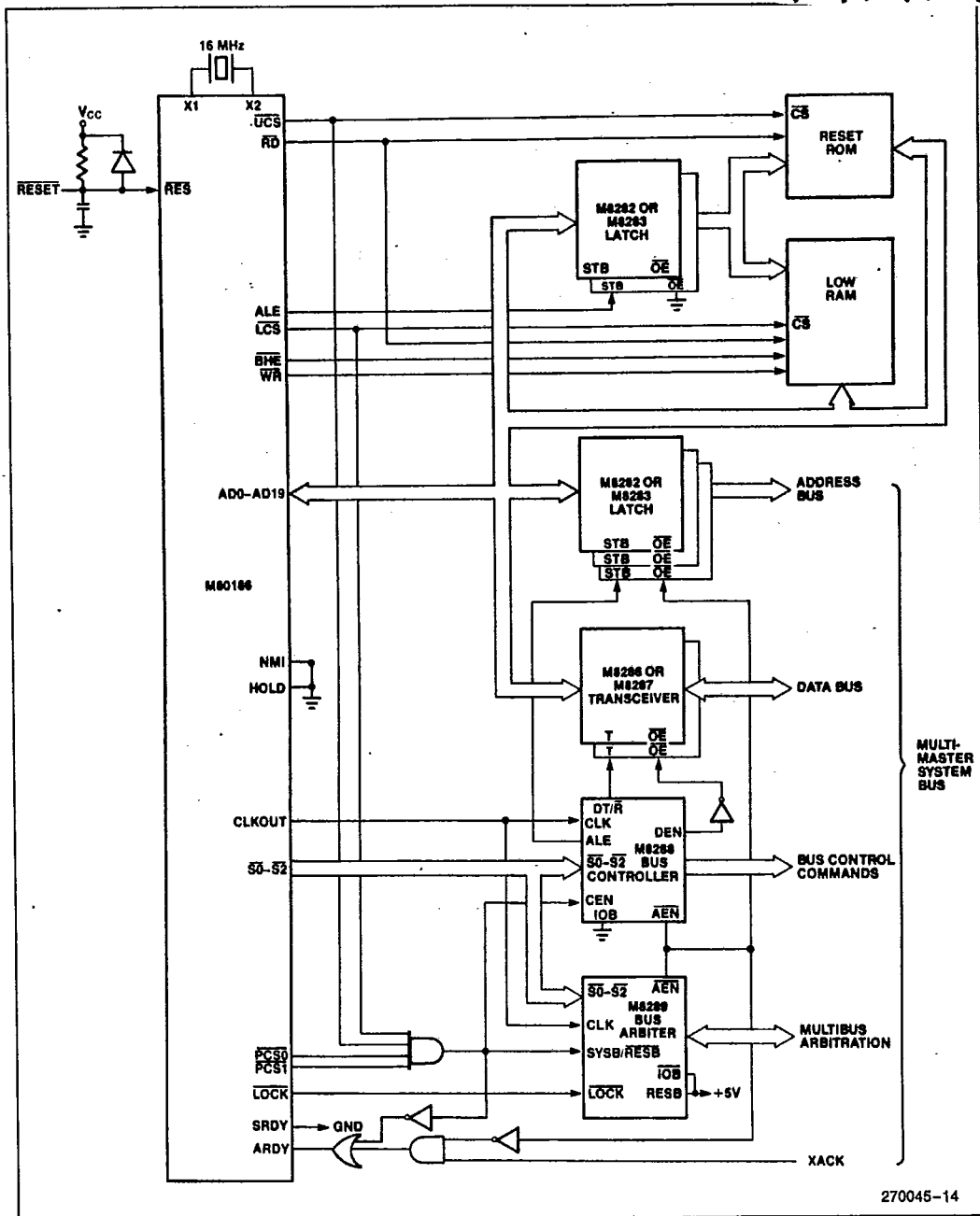

Figure 40. Typical M80186 Multi-Master Bus Interface



T-49-17-15

PACKAGE

The M80186 is available in a JEDEC type CG 68-pin, hermetic pin grid array package. Figure 41 illustrates the package dimensions.

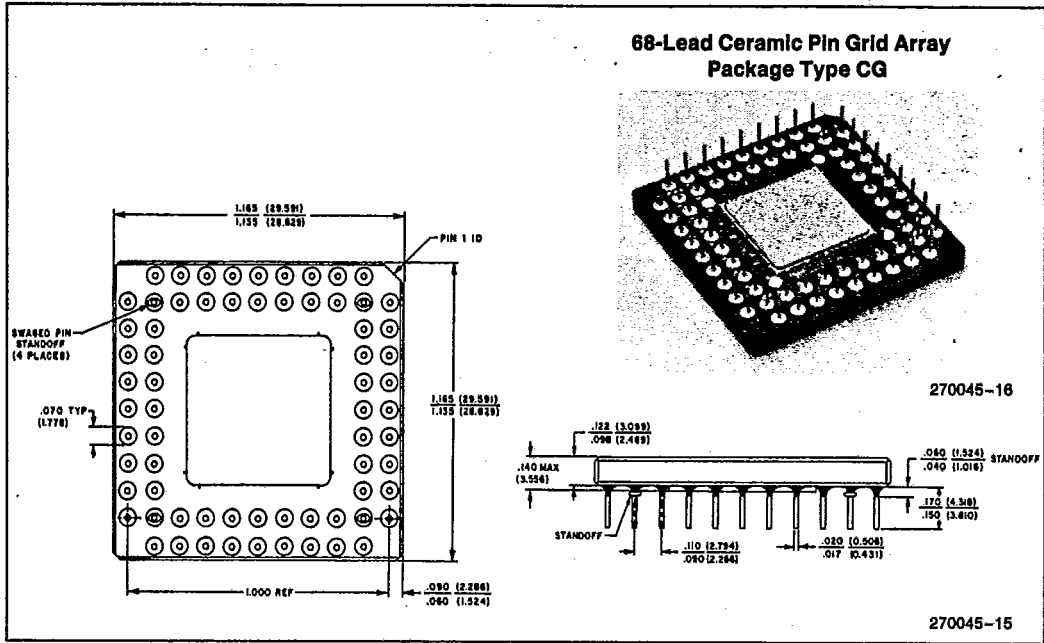
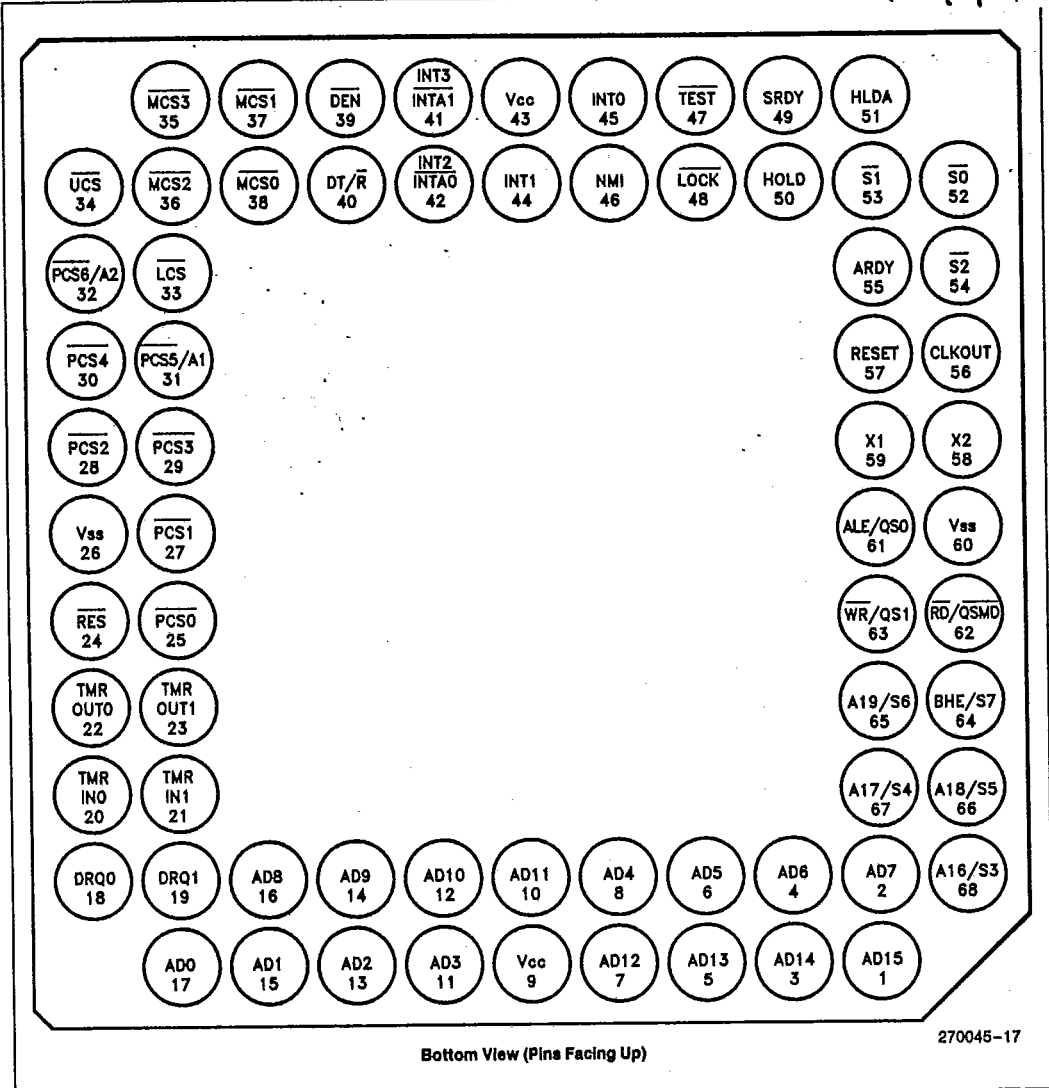

Figure 41. M80186 Pin Grid Array Package



T-49-17-15



Bottom View (Pins Facing Up)

270045-17

Figure 42. Pin Grid Array



T-49-17-15

ABSOLUTE MAXIMUM RATINGS*

Case Temperature under Bias . . . -55°C to +125°C
 Storage Temperature -65°C to +150°C
 Voltage on any Pin with
 Respect to Ground -1.0V to +7V
 Power Dissipation 3W

**Notice: Stresses above those listed under "Absolute Maximum Ratings" may cause permanent damage to the device. This is a stress rating only and functional operation of the device at these or any other conditions above those indicated in the operational sections of this specification is not implied. Exposure to absolute maximum rating conditions for extended periods may affect device reliability.*

NOTICE: Specifications contained within the following tables are subject to change.

Operating Conditions

| Symbol | Description | Min | Max | Units |
|-----------------|-------------------------------|------|------|-------|
| T _C | Case Temperature (Instant On) | -55 | +125 | °C |
| V _{CC} | Digital Supply Voltage | 4.75 | 5.25 | V |

D.C. CHARACTERISTICS (Over Specified Operating Conditions)

| Symbol | Parameter | Min | Max | Units | Comments |
|------------------|---|------|-----------------------|---------|---|
| V _{IL} | Input Low Voltage | -0.5 | +0.8 | V | |
| V _{IH} | Input High Voltage (All except X1 and \overline{RES}) | 2.0 | V _{CC} + 0.5 | V | |
| V _{IH1} | Input High Voltage (\overline{RES}) | 3.0 | V _{CC} + 0.5 | V | |
| V _{OL} | Output Low Voltage | | 0.45 | V | I _{OL} = 2.5 mA for $\overline{S0-S2}$ I _{OL} = 2.0 mA for all other outputs |
| V _{OH} | Output High Voltage | 2.4 | | V | I _{OH} = -400 μ A |
| I _{CC} | Power Supply Current | | 600 | mA | |
| I _{LI} | Input Leakage Current | | ± 10 | μ A | 0V < V _{IN} < V _{CC} |
| I _{LO} | Output Leakage Current | | ± 10 | μ A | 0.45V < V _{OUT} < V _{CC} |
| V _{CLO} | Clock Output Low | | 0.6 | V | I _{OL} = 4.0 mA |
| V _{CHO} | Clock Output High | 4.0 | | V | I _{OH} = -200 μ A |
| V _{CLI} | Clock Input Low Voltage | -0.5 | 0.3 | V | |
| V _{CHI} | Clock Input High Voltage | 3.9 | V _{CC} + 1.0 | V | |
| C _{IN} | Input Capacitance | | 10 | pF | |
| C _{IO} | I/O Capacitance | | 20 | pF | |



PIN TIMINGS

T-49-17-15

A.C. CHARACTERISTICS (Over Specified Operating Conditions)

M80186 Timing Requirements. All Timings Measured At 1.5 Volts Unless Otherwise Noted.

| Symbol | Parameter | M80186-6 (6 MHz) | | M80186-8 (8 MHz) | | Units | Comments |
|---------------------|--|---------------------|-----|---------------------|-----|-------|----------|
| | | Min | Max | Min | Max | | |
| T _{DOVCL} | Data In Setup (A/D) | 20 | | 20 | | ns | |
| T _{CLDX} | Data in Hold (A/D) | 10 | | 10 | | ns | |
| T _{ARYHCH} | Asynchronous Ready (AREADY) active setup time* | 20 | | 20 | | ns | |
| T _{ARYLCL} | AREADY inactive setup time | 38 | | 38 | | ns | |
| T _{CHARYX} | AREADY hold time | 15 | | 15 | | ns | |
| T _{ARYCHL} | Asynchronous Ready inactive hold time | 15 | | 15 | | ns | |
| T _{SRVCL} | Synchronous Ready (SREADY) transition setup time | 35 | | 35 | | ns | |
| T _{CLSRV} | SREADY transition hold time | 15 | | 15 | | ns | |
| T _{HVCL} | HOLD Setup* | 25 | | 25 | | ns | |
| T _{INVCH} | INTR, NMI, TEST, TIMERIN, Setup* | 25 | | 25 | | ns | |
| T _{INVCL} | DRQ0, DRQ1, Setup* | 25 | | 25 | | ns | |

M80186 Master Interface Timing Responses

| | | | | | | | |
|--------------------|---|------------------------|----|------------------------|----|----|---|
| T _{CLAV} | Address Valid Delay | 5 | 63 | 5 | 59 | ns | C _L = 20-200 pF all outputs |
| T _{CLAX} | Address Hold | 5 | | 5 | | ns | |
| T _{CLAZ} | Address Float Delay | T _{CLAX} | 44 | T _{CLAX} | 35 | ns | |
| T _{CHCZ} | Command Lines Float Delay | | 56 | | 45 | ns | |
| T _{CHCV} | Command Lines Valid Delay (after float) | | 76 | | 55 | ns | |
| T _{LHLL} | ALE Width | T _{CLCL} - 35 | | T _{CLCL} - 35 | | ns | |
| T _{CHLH} | ALE Active Delay | | 44 | | 35 | ns | |
| T _{CHLL} | ALE Inactive Delay | | 44 | | 35 | ns | |
| T _{LLAX} | Address Hold to ALE Inactive | T _{CHCL} - 30 | | T _{CHCL} - 25 | | ns | |
| T _{CLDV} | Data Valid Delay | 5 | 55 | 5 | 44 | ns | |
| T _{CLDOX} | Data Hold Time | 10 | | 10 | | ns | |
| T _{WHDX} | Data Hold after WR | T _{CLCL} - 50 | | T _{CLCL} - 40 | | ns | |
| T _{CVCTV} | Control Active Delay 1 | 5 | 87 | 5 | 70 | ns | |
| T _{CHCTV} | Control Active Delay 2 | 5 | 76 | 5 | 73 | ns | |
| T _{CVCTX} | Control Inactive Delay | 5 | 76 | 5 | 55 | ns | |
| T _{CVDEX} | DEN Inactive Delay (Non-Write Cycle) | 10 | 87 | 10 | 70 | ns | |
| T _{CLLV} | LOCK Delay Valid/Invalid | 5 | 73 | 5 | 69 | ns | |

*To guarantee recognition at next clock.



PIN TIMINGS (Continued)

T-49-17-15

A.C. CHARACTERISTICS (Over Specified Operating Conditions) (Continued)

M80186 Master Interface Timing Responses (Continued)

| Symbol | Parameter | M80186-6 (6 MHz) | | M80186-8 (8 MHz) | | Units | Comments |
|--------|-------------------------------|---------------------|-----|---------------------|-----|-------|------------|
| | | Min | Max | Min | Max | | |
| TAZRL | Address Float to RD Active | 0 | | 0 | | ns | |
| TCLRL | RD Active Delay | 10 | 87 | 10 | 70 | ns | |
| TCLRH | RD Inactive Delay | 10 | 76 | 10 | 55 | ns | |
| TRHAV | RD Inactive to Address Active | $T_{CLCL} - 50$ | | $T_{CLCL} - 40$ | | ns | |
| TCLHAV | HLDA Valid Delay | 5 | 67 | 5 | 67 | ns | |
| TRLRH | RD Width | $2T_{CLCL} - 50$ | | $2T_{CLCL} - 50$ | | ns | |
| TWLWH | WR Width | $2T_{CLCL} - 40$ | | $2T_{CLCL} - 40$ | | ns | |
| TAVAL | Address Valid to ALE Low | $T_{CLCH} - 45$ | | $T_{CLCH} - 25$ | | ns | |
| TCHSV | Status Active Delay | 10 | 76 | 10 | 55 | ns | |
| TCLSH | Status Inactive Delay | 10 | 76 | 10 | 65 | ns | |
| TCLTMV | Timer Output Delay | | 75 | | 60 | ns | 100 pF max |
| TCLRO | Reset Delay | | 75 | | 60 | ns | |
| TCHQSV | Queue Status Delay | | 44 | | 35 | ns | |

M80186 Chip-Select Timing Responses

| | | | | | | | |
|--------|--|----|----|----|----|----|--|
| TCLCSV | Chip-Select Active Delay | 5 | 80 | 5 | 66 | ns | |
| TCXCSX | Chip-Select Hold from Command Inactive | 35 | | 35 | | ns | |
| TCHCSX | Chip-Select Inactive Delay | 5 | 47 | 5 | 47 | ns | |

M80186 CLKIN Requirements

| | | | | | | | |
|-------|-----------------|----|-----|------|-----|----|-------------|
| TCKIN | CLKIN Period | 83 | 250 | 62.5 | 250 | ns | |
| TCKHL | CLKIN Fall Time | | 10 | | 10 | ns | 3.5 to 1.0V |
| TCKLH | CLKIN Rise Time | | 10 | | 10 | ns | 1.0 to 3.5V |
| TCLCK | CLKIN Low Time | 33 | | 25 | | ns | 1.5V |
| TCHCK | CLKIN High Time | 33 | | 25 | | ns | 1.5V |

M80186 CLKOUT Timing (200 pF load)

| | | | | | | | |
|---------|----------------------|------------------------------|------|------------------------------|-----|----|-------------|
| TClCO | CLKIN to CLKOUT Skew | | 62.5 | | 50 | ns | |
| TCLCL | CLKOUT Period | 167 | 500 | 125 | 500 | ns | |
| TCLCH | CLKOUT Low Time | $\frac{1}{2} T_{CLCL} - 7.5$ | | $\frac{1}{2} T_{CLCL} - 7.5$ | | ns | 1.5V |
| TCHCL | CLKOUT High Time | $\frac{1}{2} T_{CLCL} - 7.5$ | | $\frac{1}{2} T_{CLCL} - 7.5$ | | ns | 1.5V |
| TCH1CH2 | CLKOUT Rise Time | | 15 | | 15 | ns | 1.0 to 3.5V |
| TCL2CL1 | CLKOUT Fall Time | | 15 | | 15 | ns | 3.5 to 1.0V |



T. 49-17-15

WAVEFORMS (Continued)

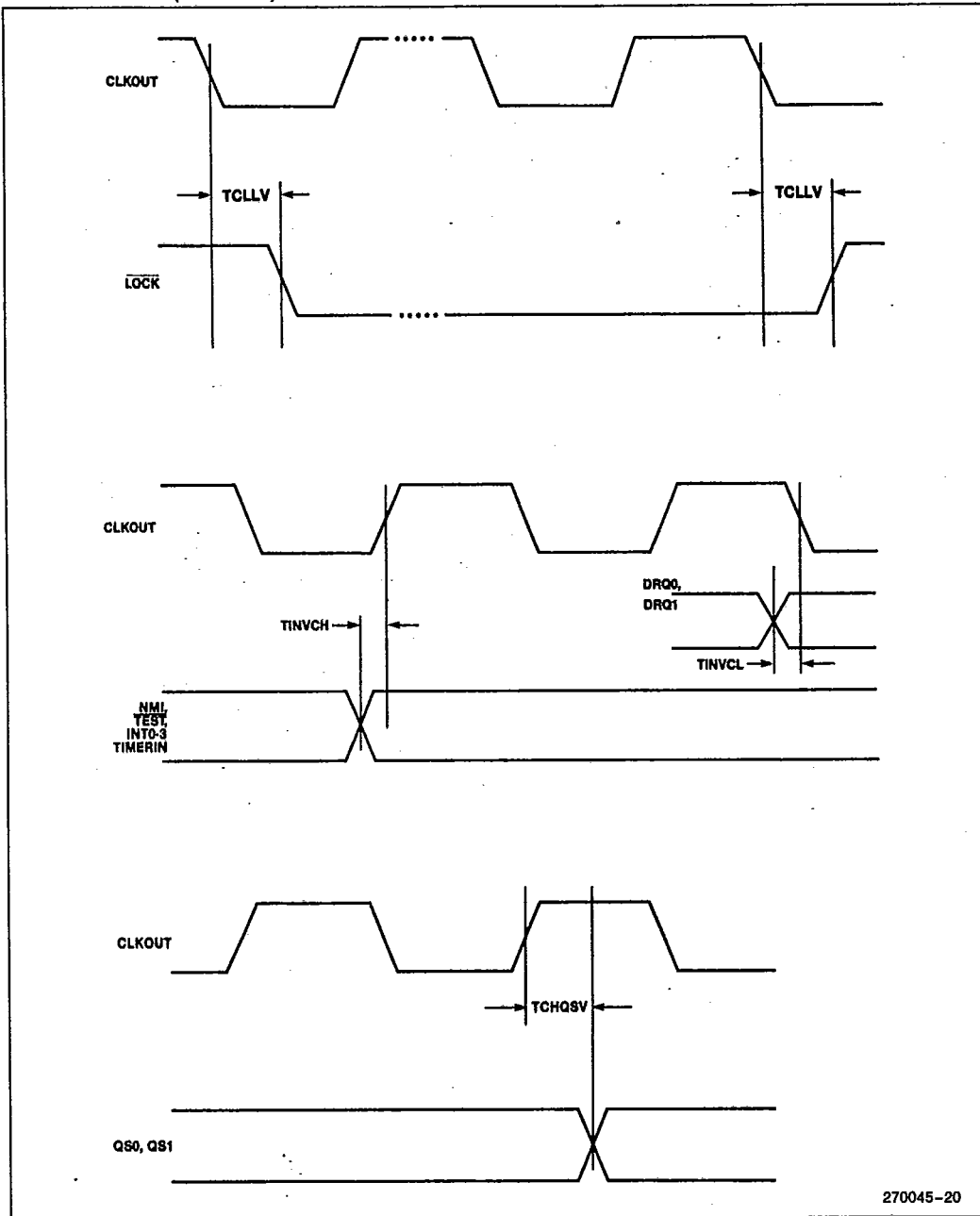

270045-20



T-49-17-15

INSTRUCTION SET SUMMARY

| Function | Format | Clock Cycles | Comments |
|-------------------------------------|---------------------------------------|--------------|----------|
| DATA TRANSFER | | | |
| MOV = Move: | | | |
| Register to Register/Memory | 1000100w mod reg r/m | 2/12 | |
| Register/memory to register | 1000101w mod reg r/m | 2/9 | |
| Immediate to register/memory | 1100011w mod 000 r/m data data if w=1 | 12-13 | 8/16-bit |
| Immediate to register | 1011w reg data data if w=1 | 3-4 | 8/16-bit |
| Memory to accumulator | 1010000w addr-low addr-high | 9 | |
| Accumulator to memory | 1010001w addr-low addr-high | 8 | |
| Register/memory to segment register | 10001110 mod 0 reg r/m | 2/9 | |
| Segment register to register/memory | 10001100 mod 0 reg r/m | 2/11 | |
| PUSH = Push: | | | |
| Memory | 11111111 mod 110 r/m | 16 | |
| Register | 01010 reg | 10 | |
| Segment register | 000 reg 110 | 9 | |
| Immediate | 011010s0 data data if s=0 | 10 | |
| PUSHA = Push All | | | |
| | 01100000 | 29 | |
| POP = Pop: | | | |
| Memory | 10001111 mod 000 r/m | 20 | |
| Register | 01011 reg | 10 | |
| Segment register | 000 reg 111 (reg≠01) | 8 | |
| POPA = Pop All | | | |
| | 01100001 | 21 | |
| XCHG = Exchange: | | | |
| Register/memory with register | 1000011w mod reg r/m | 4/17 | |
| Register with accumulator | 10010 reg | 3 | |
| IN = Input from: | | | |
| Fixed port | 1110010w port | 10 | |
| Variable port | 1110110w | 8 | |
| OUT = Output to: | | | |
| Fixed port | 1110011w port | 9 | |
| Variable port | 1110111w | 7 | |
| XLAT = Translate byte to AL | 11010111 | 11 | |
| LEA = Load EA to register | 10001101 mod reg r/m | 6 | |
| LDS = Load pointer to DS | 11000101 mod reg r/m (mod≠11) | 18 | |
| LES = Load pointer to ES | 11000100 mod reg r/m (mod≠11) | 18 | |
| LAHF = Load AH with flags | 10011111 | 2 | |
| SAHF = Store AH into flags | 10011110 | 3 | |
| PUSHF = Push flags | 10011100 | 9 | |
| POPF = Pop flags | 10011101 | 8 | |

Shaded areas indicate instructions not available in M8086, M8088 microsystems.



T-49-17-15

INSTRUCTION SET SUMMARY (Continued)

| Function | Format | Clock Cycles | Comments |
|------------------------------------|---|--------------|----------|
| DATA TRANSFER (Continued) | | | |
| SEGMENT = Segment Override: | | | |
| CS | 00101110 | 2 | |
| SS | 00110110 | 2 | |
| DS | 00111110 | 2 | |
| ES | 00100110 | 2 | |
| ARITHMETIC | | | |
| ADD = Add: | | | |
| Reg/memory with register to either | 000000dw mod reg r/m | 3/10 | |
| Immediate to register/memory | 100000sw mod 000 r/m data data if sw=01 | 4/16 | |
| Immediate to accumulator | 0000010w data data if w=1 | 3/4 | 8/16-bit |
| ADC = Add with carry: | | | |
| Reg/memory with register to either | 000100dw mod reg r/m | 3/10 | |
| Immediate to register/memory | 100000sw mod 010 r/m data data if sw=01 | 4/16 | |
| Immediate to accumulator | 0001010w data data if w=1 | 3/4 | 8/16-bit |
| INC = Increment: | | | |
| Register/memory | 1111111w mod 000 r/m | 3/15 | |
| Register | 01000 reg | 3 | |
| SUB = Subtract: | | | |
| Reg/memory and register to either | 001010dw mod reg r/m | 3/10 | |
| Immediate from register/memory | 100000sw mod 101 r/m data data if sw=01 | 4/16 | |
| Immediate from accumulator | 0010110w data data if w=1 | 3/4 | 8/16-bit |
| SBB = Subtract with borrow: | | | |
| Reg/memory and register to either | 000110dw mod reg r/m | 3/10 | |
| Immediate from register/memory | 100000sw mod 011 r/m data data if sw=01 | 4/16 | |
| Immediate from accumulator | 0001110w data data if w=1 | 3/4 | 8/16-bit |
| DEC = Decrement | | | |
| Register/memory | 1111111w mod 001 r/m | 3/15 | |
| Register | 01001 reg | 3 | |
| CMP = Compare: | | | |
| Register/memory with register | 0011101w mod reg r/m | 3/10 | |
| Register with register/memory | 0011100w mod reg r/m | 3/10 | |
| Immediate with register/memory | 100000sw mod 111 r/m data data if sw=01 | 3/10 | |
| Immediate with accumulator | 0011110w data data if w=1 | 3/4 | 8/16-bit |
| NEG = Change sign | 1111011w mod 011 r/m | 3 | |
| AAA = ASCII adjust for add | 00110111 | 8 | |
| DAA = Decimal adjust for add | 00100111 | 4 | |
| AAS = ASCII adjust for subtract | 00111111 | 7 | |
| DAS = Decimal adjust for subtract | 00101111 | 4 | |
| MUL = Multiply (unsigned): | | | |
| Register-Byte | 1111011w mod 100 r/m | 26-28 | |
| Register-Word | | 35-37 | |
| Memory-Byte | | 32-34 | |
| Memory-Word | | 41-43 | |

Shaded areas indicate instructions not available in M8086, M8088 microsystems.



INSTRUCTION SET SUMMARY (Continued)

| Function | Format | Clock Cycles | Comments |
|---|---------------------------------------|-----------------|----------|
| ARITHMETIC (Continued) | | | |
| IMUL = Integer multiply (signed): | 1111011w mod 101 r/m | | |
| Register-Byte | | 25-28 | |
| Register-Word | | 34-37 | |
| Memory-Byte | | 31-34 | |
| Memory-Word | | 40-43 | |
| IMUL = Integer Immediate multiply (signed) | 011010s1 mod reg r/m data data if s=0 | 22-25/ 29-32 | |
| DIV = Divide (unsigned): | 1111011w mod 110 r/m | | |
| Register-Byte | | 29 | |
| Register-Word | | 38 | |
| Memory-Byte | | 35 | |
| Memory-Word | | 44 | |
| IDIV = Integer divide (signed): | 1111011w mod 111 r/m | | |
| Register-Byte | | 44-52 | |
| Register-Word | | 53-61 | |
| Memory-Byte | | 50-58 | |
| Memory-Word | | 59-67 | |
| AAM = ASCII adjust for multiply | 11010100 00001010 | 19 | |
| AAD = ASCII adjust for divide | 11010101 00001010 | 15 | |
| CBW = Convert byte to word | 10011000 | 2 | |
| CWD = Convert word to double word | 10011001 | 4 | |
| LOGIC | | | |
| Shift/Rotate Instructions: | | | |
| Register/Memory by 1 | 1101000w mod TTT r/m | 2/15 | |
| Register/Memory by CL | 1101001w mod TTT r/m | 5+n/17+n | |
| Register/Memory by Count | 1100000w mod TTT r/m count | 5+n/17+n | |
| | TTT Instruction | | |
| | 000 ROL | | |
| | 001 ROR | | |
| | 010 RCL | | |
| | 011 RCR | | |
| | 100 SHL/SAL | | |
| | 101 SHR | | |
| | 111 SAR | | |
| AND = And: | | | |
| Reg/memory and register to either | 001000dw mod reg r/m | 3/10 | |
| Immediate to register/memory | 1000000w mod 100 r/m data data if w=1 | 4/16 | |
| Immediate to accumulator | 0010010w data data if w=1 | 3/4 | 8/16-bit |
| TEST = And function to flags, no result: | | | |
| Register/memory and register | 1000010w mod reg r/m | 3/10 | |
| Immediate data and register/memory | 1111011w mod 000 r/m data data if w=1 | 4/10 | |
| Immediate data and accumulator | 1010100w data data if w=1 | 3/4 | 8/16-bit |
| OR = Or: | | | |
| Reg/memory and register to either | 000010dw mod reg r/m | 3/10 | |
| Immediate to register/memory | 1000000w mod 001 r/m data data if w=1 | 4/16 | |
| Immediate to accumulator | 0000110w data data if w=1 | 3/4 | 8/16-bit |

Shaded areas indicate instructions not available in M8086, M8088 microsystems.



T-49-17-15

INSTRUCTION SET SUMMARY (Continued)

| Function | Format | Clock Cycles | Comments |
|---|--|--------------|----------|
| LOGIC (Continued) | | | |
| XOR = Exclusive or: | | | |
| Reg/memory and register to either | 001100dw mod reg r/m | 3/10 | |
| Immediate to register/memory | 1000000w mod 110 r/m data data if w=1 | 4/16 | |
| Immediate to accumulator | 0011010w data data if w=1 | 3/4 | 8/16-bit |
| NOT = Invert register/memory | 1111011w mod 010 r/m | 3 | |
| STRING MANIPULATION | | | |
| MOVS = Move byte/word | 1010010w | 14 | |
| CMPS = Compare byte/word | 1010011w | 22 | |
| SCAS = Scan byte/word | 1010111w | 15 | |
| LODS = Load byte/wd to ALAX | 1010110w | 12 | |
| STOS = Stor byte/wd from ALA | 1010101w | 10 | |
| INS = Input byte/wd from DX port | 0110110w | 14 | |
| OUTS = Output byte/wd to DX port | 0110111w | 14 | |
| Repeated by count in CX | | | |
| MOVS = Move string | 11110010 1010010w | 8+8n | |
| CMPS = Compare string | 1111001z 1010011w | 5+22n | |
| SCAS = Scan string | 1111001z 1010111w | 5+15n | |
| LODS = Load string | 11110010 1010110w | 6+11n | |
| STOS = Store string | 11110010 1010101w | 6+9n | |
| INS = Input string | 11110010 0110110w | 8+8n | |
| OUTS = Output string | 11110010 0110111w | 8+8n | |
| CONTROL TRANSFER | | | |
| CALL = Call: | | | |
| Direct within segment | 11101000 disp-low disp-high | 15 | |
| Register/memory indirect within segment | 11111111 mod 010 r/m | 13/19 | |
| Direct intersegment | 10011010 segment offset segment selector | 23 | |
| Indirect intersegment | 11111111 mod 011 r/m (mod ≠ 11) | 38 | |
| JMP = Unconditional Jump: | | | |
| Short/long | 11101011 disp-low | 14 | |
| Direct within segment | 11101001 disp-low disp-high | 14 | |
| Register/memory indirect within segment | 11111111 mod 100 r/m | 11/17 | |
| Direct intersegment | 11101010 segment offset segment selector | 14 | |
| Indirect intersegment | 11111111 mod 101 r/m (mod ≠ 11) | 28 | |

Shaded areas indicate instructions not available in M8086, M8088 microsystems.



T-49-17-15

INSTRUCTION SET SUMMARY (Continued)

| Function | Format | Clock Cycles | Comments | |
|--|-------------------------------------|--------------------------|-------------------------------------|---------------------------|
| CONTROL TRANSFER (Continued) | | | | |
| RET = Return from CALL: | | | | |
| Within segment | 11000011 | 16 | | |
| Within seg adding Immed to SP | 11000010 data-low data-high | 18 | | |
| Intersegment | 11001011 | 22 | | |
| Intersegment adding Immediate to SP | 11001010 data-low data-high | 25 | | |
| JE/JZ = Jump on equal/zero | 01110100 disp | 4/13 | JMP not taken/JMP taken | |
| JL/JNGE = Jump on less/not greater or equal | 01111100 disp | 4/13 | | |
| JLE/JNG = Jump on less or equal/not greater | 01111110 disp | 4/13 | | |
| JB/JNAE = Jump on below/not above or equal | 01110010 disp | 4/13 | | |
| JBE/JNA = Jump on below or equal/not above | 01110110 disp | 4/13 | | |
| JP/JPE = Jump on parity/parity even | 01111010 disp | 4/13 | | |
| JO = Jump on overflow | 01110000 disp | 4/13 | | |
| JS = Jump on sign | 01111000 disp | 4/13 | | |
| JNE/JNZ = Jump on not equal/not zero | 01110101 disp | 4/13 | | |
| JNL/JGE = Jump on not less/greater or equal | 01111101 disp | 4/13 | | |
| JNLE/JG = Jump on not less or equal/greater | 01111111 disp | 4/13 | | |
| JNB/JAE = Jump on not below/above or equal | 01110011 disp | 4/13 | | |
| JNBE/JA = Jump on not below or equal/above | 01110111 disp | 4/13 | | |
| JNP/JPO = Jump on not par/par odd | 01111011 disp | 4/13 | | |
| JNO = Jump on not overflow | 01110001 disp | 4/13 | | |
| JNS = Jump on not sign | 01111001 disp | 4/13 | | |
| JCXZ = Jump on CX zero | 11100011 disp | 5/15 | | |
| LOOP = Loop CX times | 11100010 disp | 6/16 | | LOOP not taken/LOOP taken |
| LOOPZ/LOOPE = Loop while zero/equal | 11100001 disp | 6/16 | | |
| LOOPNZ/LOOPNE = Loop while not zero/equal | 11100000 disp | 6/16 | | |
| ENTER = Enter Procedure | 11001000 data-low data-high L | 15 25 22 + 16(n-1) | | |
| L = 0 | | | | |
| L = 1 | | | | |
| L > 1 | | | | |
| LEAVE = Leave Procedure | 11001001 | 6 | | |
| INT = Interrupt: | | | | |
| Type specified | 11001101 type | 47 | if INT. taken/ if INT. not taken | |
| Type 3 | 11001100 | 45 | | |
| INTO = Interrupt on overflow | 11001110 | 48/4 | | |
| IRET = Interrupt return | 11001111 | 28 | | |
| BOUND = Detect value out of range | 01100010 mod reg r/m | 33-35 | | |

Shaded areas indicate instructions not available in M8086, M8088 microsystems.



T-49-17-15

INSTRUCTION SET SUMMARY (Continued)

| Function | Format | Clock Cycles | Comments |
|---|----------------------|--------------|-------------|
| PROCESSOR CONTROL | | | |
| CLC = Clear carry | 11111000 | 2 | |
| CMC = Complement carry | 11110101 | 2 | |
| STC = Set carry | 11111001 | 2 | |
| CLD = Clear direction | 11111100 | 2 | |
| STD = Set direction | 11111101 | 2 | |
| CLI = Clear interrupt | 11111010 | 2 | |
| STI = Set interrupt | 11111011 | 2 | |
| HLT = Halt | 11110100 | 2 | |
| WAIT = Wait | 10011011 | 6 | if test = 0 |
| LOCK = Bus lock prefix | 11110000 | 2 | |
| ESC = Processor Extension Escape | 11011TTT mod LLL r/m | 6 | |
| (TTT LLL are opcode to processor extension) | | | |

Shaded areas indicate instructions not available in M8086, M8088 microsystems.



T-49-17-15

FOOTNOTES

The Effective Address (EA) of the memory operand is computed according to the mod and r/m fields:

if mod = 11 then r/m is treated as a REG field

if mod = 00 the DISP = 0*, disp-low and disp-high are absent

if mod = 01 then DISP = disp-low sign-extended to 16-bits, disp-high is absent

if mod = 10 the DISP = disp-high: disp-low

if r/m = 000 then EA = (BX) + (SI) + DISP

if r/m = 001 then EA = (BX) + (DI) + DISP

if r/m = 010 then EA = (BP) + (SI) + DISP

if r/m = 011 then EA = (BP) + (DI) + DISP

if r/m = 100 then EA = (SI) + DISP

if r/m = 101 then EA = (DI) + DISP

if r/m = 110 then EA = (BP) + DISP*

if r/m = 111 then EA = (BX) + DISP

DISP follows 2nd byte of instruction (before data if required)

*NOTE:

Except if mod = 00 and r/m = 110 then EA = disp-high: disp-low.

NOTE:

EA calculation time is 4 clock cycles for all modes, and is included in the execution times given whenever appropriate.

Segment Override Prefix

| | | | | | | |
|---|---|---|-----|---|---|---|
| 0 | 0 | 1 | reg | 1 | 1 | 0 |
|---|---|---|-----|---|---|---|

reg is assigned according to the following:

| reg | Segment Register |
|-----|------------------|
| 00 | ES |
| 01 | CS |
| 10 | SS |
| 11 | DS |

REG is assigned according to the following table:

| 16-Bit (w = 1) | 8-Bit (w = 0) |
|----------------|---------------|
| 000 AX | 000 AL |
| 001 CX | 001 CL |
| 010 DX | 010 DL |
| 011 BX | 011 BL |
| 100 SP | 100 AH |
| 101 BO | 101 CH |
| 110 SI | 110 DH |
| 111 DI | 111 BH |

The physical addresses of all operands addressed by the BP register are computed using the SS segment register. The physical addresses of the destination operands of the string primitive operations (those addressed by the DI register) are computed using the ES segment, which may not be overridden.